

## TACCOR ULTRAFAST FEMTOSECOND LASER DATA SHEET

# TURN-KEY GHZ FEMTOSECOND LASER

Novanta develops photonics solutions specializing in cutting-edge components and sub-systems for laser-based diagnostic, analytical, micromachining and fine material processing applications. Powerful lasers, coupled with advanced beam steering and intelligent sub-systems incorporating software and controls, deliver extreme precision and performance, tailored to our customers' demanding applications.

## INTELLIGENT CONTROL

The taccor is a unique turn-key femtosecond laser with a 1 GHz or 10 GHz repetition rate that delivers up to 1.8 W of average power in pulses that can be <math><30\text{ fs}</math>. Tunability is offered between 740 nm and 930 nm. Its innovative design combines a compact hermetically sealed, vibration-resistant laser head that incorporates the Ti:Sapphire oscillator and pump laser, with a full-feature control unit. The control unit provides intelligent control that monitors laser performance and carries out diagnostics analysis. The result is a highly stable and reproducible product with a long lifetime and low cost of ownership. There are four versions of the taccor: The taccor one offers a selectable (fixed) wavelength; the taccor power is optimized to produce the highest power; the taccor tune offers the flexibility of a tunable wavelength using a touch screen or control software and the taccor x10 operating at a 10 times higher repetition rate.

## OPTIONAL FEATURES

### Active locking of repetition rate and pulse timing

The TL-1000 is an optional supporting unit that enables tight phase-locking of the repetition rate to an external reference with jitter <math><100\text{ fs}</math>. TL-1000-ASOPS enables a repetition rate offset lock between two GHz oscillators of 2 kHz to 20 kHz allowing ultrafast time-domain spectroscopy without a mechanical delay stage.

### Pulse train monitoring

An integrated high bandwidth (10 GHz) photodiode can be used for repetition rate monitoring and to supply a signal to the TL-1000 units or external electronics.

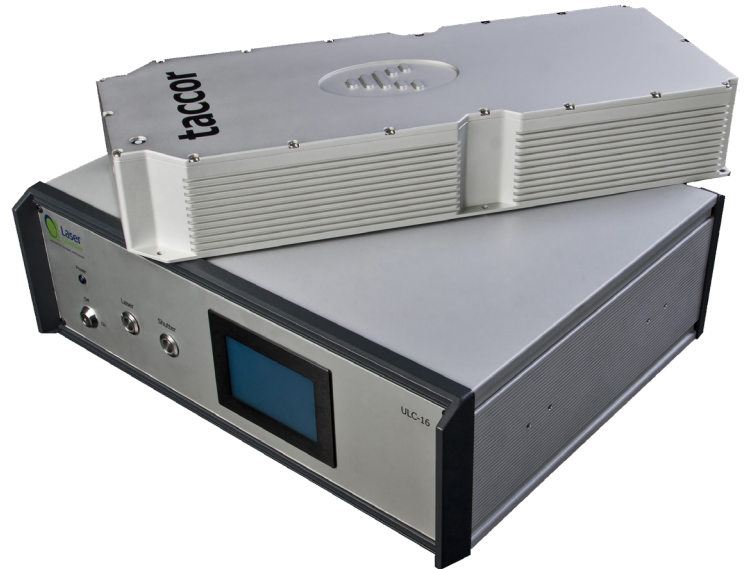

Self-locking and maintaining, wavelength tunable

### Repetition rate control

Control of the repetition rate and active feedback is enabled by cavity mirrors mounted on a fast and slow piezo crystal enabling rapid feedback and drift control simultaneously; in combination with the TL-1000 unit, this offers precision closed loop stabilization of the repetition rate. Alternatively, the piezos can be driven by customer supplied electronics.

### CEPLoQ™ technology

CEPLoQ™ is our patented technology that directly modulates the pump power to maintain phase stabilization without the use of an AOM. This leads to faster and more stable responses than the traditional method.

### Second harmonic generation

Together with A.P.E. Angewandte Physik & Elektronik GmbH, Laser Quantum can offer the HarmoniXX second harmonic frequency converter for use with the taccor power. Maintaining the benefits of the 1 GHz repetition rate, it offers up to 250 mW of frequency doubled output.

# TACCOR ULTRAFAST FEMTOSECOND LASER

## TACCOR POWER

The taccor power is optimized for the highest possible output, offering up to 1.8 W at the Ti:Sapphire gain maximum around 800 nm.

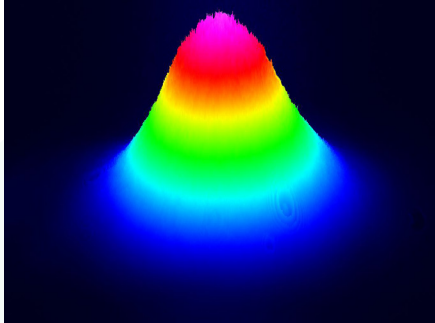

3D beam profile from a taccor series laser.

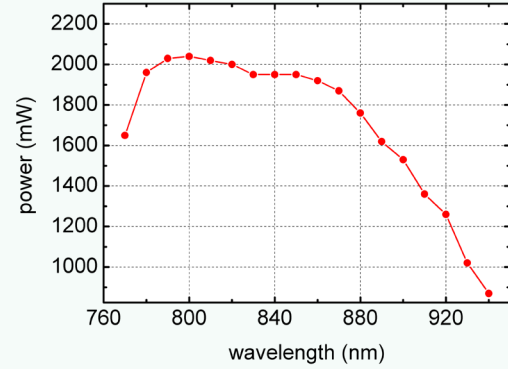

Power tuning curve for the long wavelength taccor tune (example shown is taccor tune 10).

## TACCOR X10

The high repetition rate (10 GHz) version of the taccor. Giving up to 1 mW per comb line spaced by 10 GHz, the taccor x10 is unique to the market and opens a wide field of new applications such as resolved mode spectroscopy, low-noise microwave generation, astrocombs or arbitrary waveform generation. Analogue to the other version of the taccor, the taccor x10 can also be configured to allow the control of the repetition rate and gives modulation access for the pump power to enable an easy control of the carrier offset frequency.

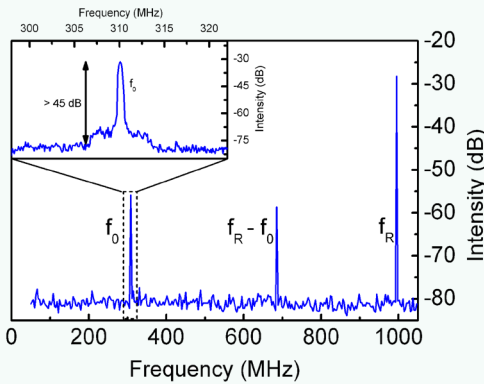

RF spectrum showing the fCEO beat, the difference frequency of the repetition rate with the fCEO beat and the repetition rate. The noise floor is given by the spectrum analyzer.

## TACCOR TUNE

The taccor tune offers the flexibility of a tunable wavelength using a touch screen or control software; a true hands free laser covering the wavelength regime from 740 nm to 930 nm which is unique to the market.

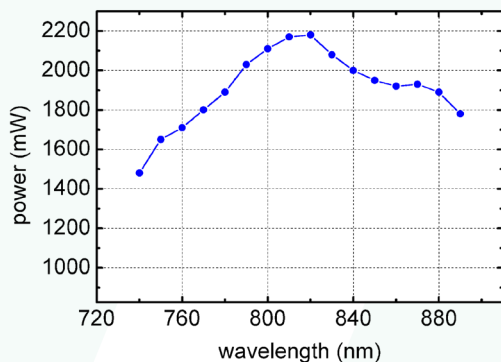

Power tuning curve for the short wavelength taccor tune (example shown is taccor tune 10).

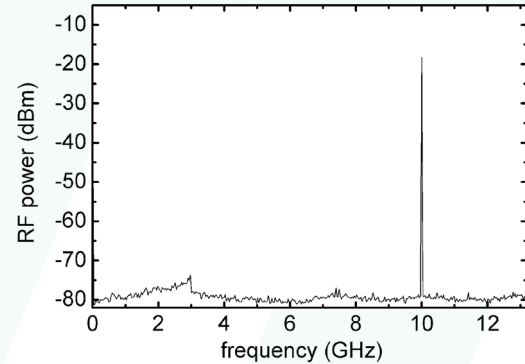

RF spectrum of the signal from the high bandwidth repetition rate measurement photodiode in the taccor (PD option). The noise floor is given by the spectrum analyzer.

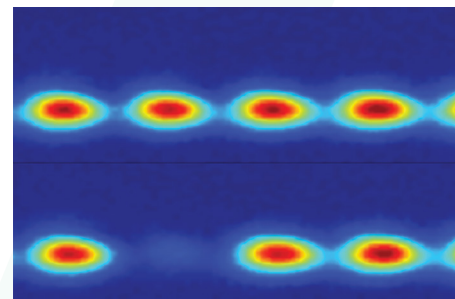

Individually resolved comb modes after passing the taccor x10 beam through a Rb cell. In the lower image, one mode is on resonance with an absorption line.

## TACCOR ULTRAFAST FEMTOSECOND LASER SPECIFICATIONS

Specification*	taccor power	taccor tune	taccor X10
Average Power Output <sup>1</sup>	power 6 > 1000 mW power 10 > 1800 mW	tune 10 > 1800 mW	> 1000 mW
Center Wavelength	nominal 800 nm ( $\pm 20$ nm)	740 nm to 930 nm (tuneable) <sup>3</sup>	830 nm $\pm 30$ nm
Pulse Duration <sup>4</sup>	< 30 fs	< 80 fs	< 50 fs
Spectral FWHM	> 23 nm	-15 nm	> 15 nm
Repetition Rate <sup>5</sup>	1 GHz		10 GHz
Pulse Energy	0.8 nJ to 1.8 nJ	1.3 nJ - 1.8 nJ taccor tune 10	> 100 pJ
Beam Size	0.8 mm $\pm 0.3$ mm		0.7 mm $\pm 0.3$ mm
Divergence	2 mrad $\pm 0.5$ mrad		< 10 mrad
M <sup>2</sup>	< 1.2 (sag plane), < 1.2 (tan plane)	< 1.2 (sag plane), < 1.6 (tan plane)	< 1.5 (sag plane), < 1.5 (tan plane)
Power Stability <sup>6</sup>	< 1%		
Noise (RMS)	< 0.05%		
Polarization Ratio	> 100:1		
Polarization Direction	Horizontal		
Operating Temperature	21° C $\pm 5$ ° C		
Applications	two photon microscopy, two photon polymerization, optical precision metrology, ASOPS, optical spectroscopy, ultrafast spectroscopy, frequency comb generation, arbitrary waveform generation, calibration of spectographs (astrometry)		

\*Laser Quantum operates a continuous improvement programme which can result in specifications being improved without notice.

1 Measured as the spectral centroid.

2 Achieved using optional extra cavity dispersion compensation.

3 Noise bandwidth 1 Hz to 1 MHz.

4 FWHM beam diameter at laser exit.

5 Repetition rate accuracy  $\pm 100$  kHz. Other repetition rates available upon request.

# TACCOR ULTRAFAST FEMTOSECOND LASER

## DIMENSIONS (mm)

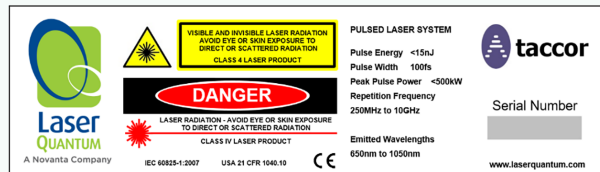
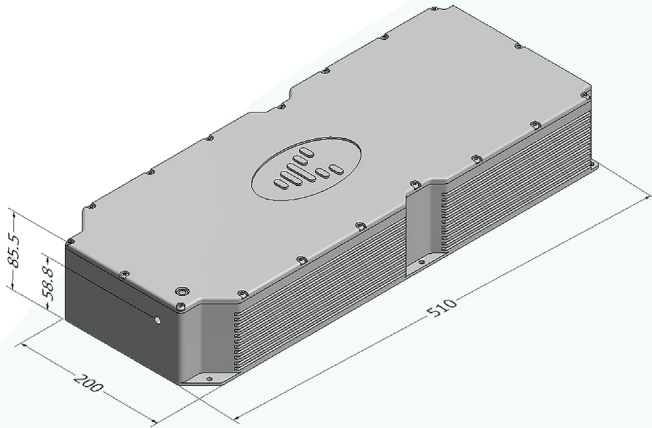

Drawings are for illustrative purposes only, please contact us for complete engineer's drawings

## ADDITIONAL INFORMATION

- Enables two-color pump-probe experiments
- Umbilical length: 2 m
- Head weight: 15 kgs
- Cooling system included
- Warm-up time: 10 minutes
- Self-locking and maintaining
- Stable and robust
- True hands off turn-key system
- Wavelength tunable
- Integrated pump laser
- The taccor is compatible with the Laser Quantum's software that allows connection to the Laser Quantum support team for monitoring laser performance and diagnosing opportunities for carrying out laser optimization.
- Pump power modulation - Modulation access to the pump power with a bandwidth of >100 kHz and modulation depth up to  $\pm 1\%$  is provided for feedback purposes.

## POWER SUPPLY UNIT

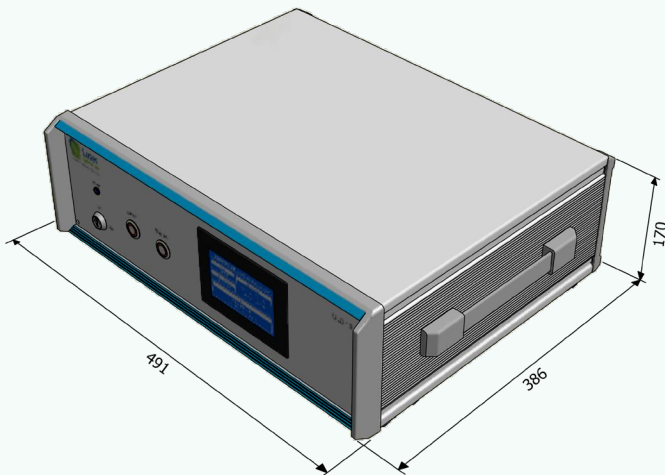

## CONTACT US

### Americas, Asia Pacific

Novanta Headquarters  
Bedford, USA  
P +1-781-266-5700

Photonics@Novanta.com

### Europe, Middle East, Africa

Novanta Europe GmbH  
Wackersdorf, Germany  
P +49 9431 7984-0

Milan, Italy  
P +39-039-793-710

Photonics@Novanta.com

### China

Novanta Sales & Service Office  
Shenzhen, China  
P +86-755-8280-5395

Suzhou, China  
P +86-512-6283-7080

Photonics.China@Novanta.com

### Japan

Novanta Service & Sales Office  
Tokyo, Japan  
P +81-3-5753-2460

Photonics.Japan@Novanta.com