

# ORDER THE CROSSFIRE PRO CNC PLASMA

**48.25" x 33.3" CNC Plasma Table** featuring Powered Z-axis, Initial Height Sensing, and optional automatic THC module.

CROSSFIRE PRO ORDERS PLACED TODAY ESTIMATED SHIPPING **WITHIN 2 WEEKS.**







## Included:

What to Expect → (/what-to-expect)

- ✓ **CrossFire PRO CNC Plasma Table** **\$2749**  
 Complete ready-to-assemble CNC Plasma Machine.
- ✓ **Water Table**  
 Stainless Steel Water Table is standard on the CrossFire PRO.
- ✓ **FireControl Motion Control Software**  
 Developed to control the CrossFire line of CNC Machines.
- ✓ **Autodesk Fusion 360 CAD/CAM Software**  
 Powerful CAD/CAM Software that is Free for personal (non-commercial) and educational use.

## Add-ons:

-  **Laptop Stand**  
 Laptop Stand purpose built for the PRO. **\$85**
-  **Automatic Torch Height Controller (THC)**  
 Maintains torch height above material during cutting for optimal cut quality. **\$400**
-  **Razorweld 45 CNC Plasma Cutter with Hand Torch**  
 45 Amp, 1/2" Steel Cut Capacity, Plug-N-Play CNC Port, and X45 Hand Torch. Or use your own (/plasma-cutters). **\$995**
-  **Razorweld 45 CNC Plasma Cutter with Machine Torch**  
 45 Amp, 1/2" Steel Cut Capacity, Plug-N-Play CNC Port, X45 Machine Torch, & required Machine Torch Mount  
 (<https://store.langmuirsystems.com/collections/add-ons/products/crossfire-crossfire-pro-machine-torch-mount>). **\$1170**
-  **NEW! Hypertherm 45 XP with Machine Torch**  
 45 Amp, 5/8" Steel Cut Capacity, CPC Port, with Machine Torch Mount  
 (<https://store.langmuirsystems.com/collections/add-ons/products/crossfire-crossfire-pro-machine-torch-mount>) and CPC Cable (<https://store.langmuirsystems.com/collections/add-ons/products/hypertherm-cpc-cable-for-crossfire-crossfire-pro-cnc>). **\$2775**  
[More Info →](#)  
 ([https://assets.langmuirsystems.com/file/hypertherm/Hypertherm\\_45XP.pdf](https://assets.langmuirsystems.com/file/hypertherm/Hypertherm_45XP.pdf))

ORDER NOW(<https://store.langmuirsystems.com/cart/31823924789326:1>) ~~\$3000~~ **\$2749**  
 +\$249 flat rate shipping to contiguous USA.

Starting at \$96/mo with . Prequalify now

**CrossFire PRO machine orders placed today are estimated to ship within 2 weeks.** You are entitled to a full refund minus a 2.4% transaction fee until your order ships.

# PRODUCTION READY

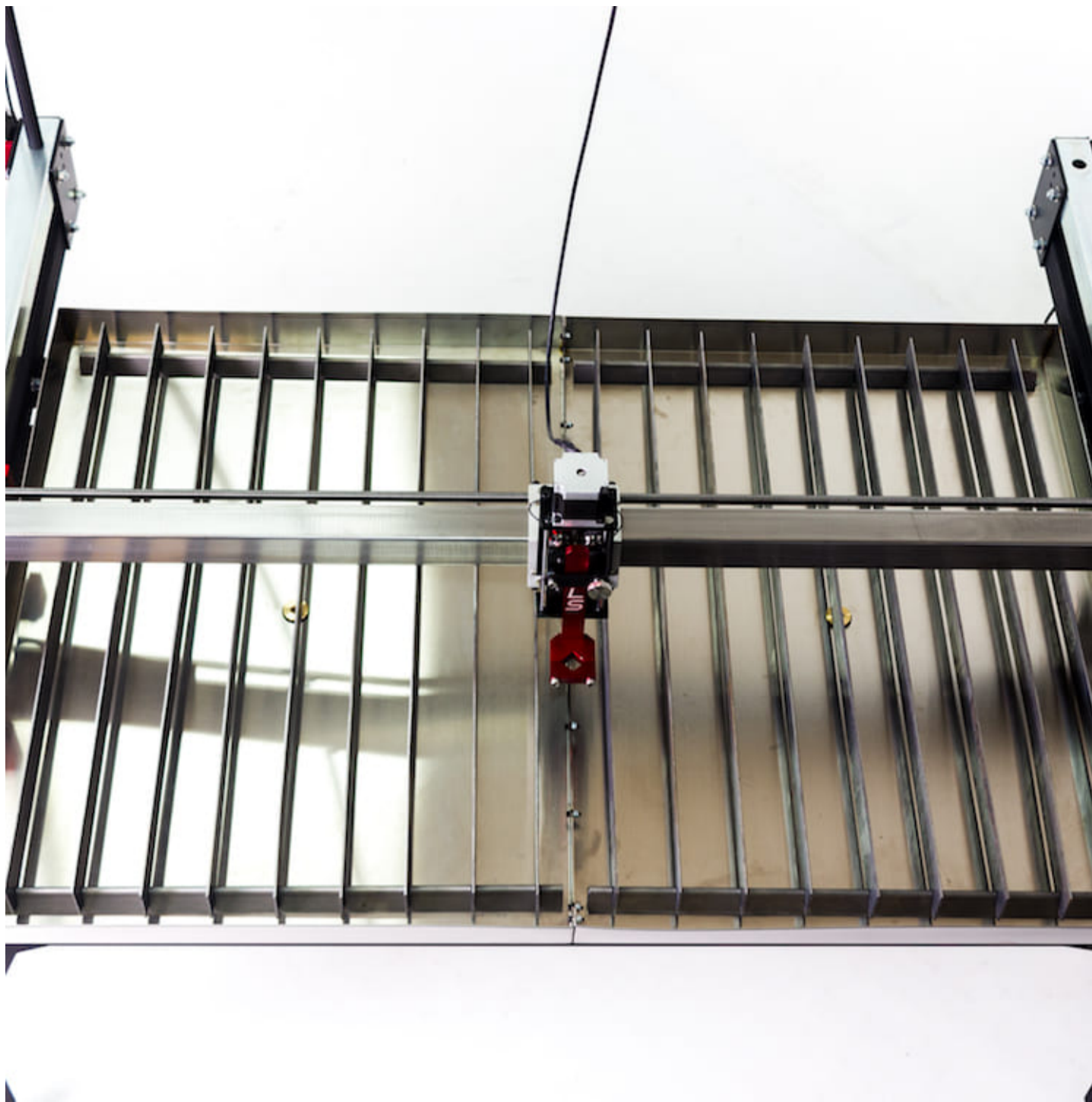

### Large Work Area

Water Table sized to cut full width sheets  
so you can cut more parts faster.

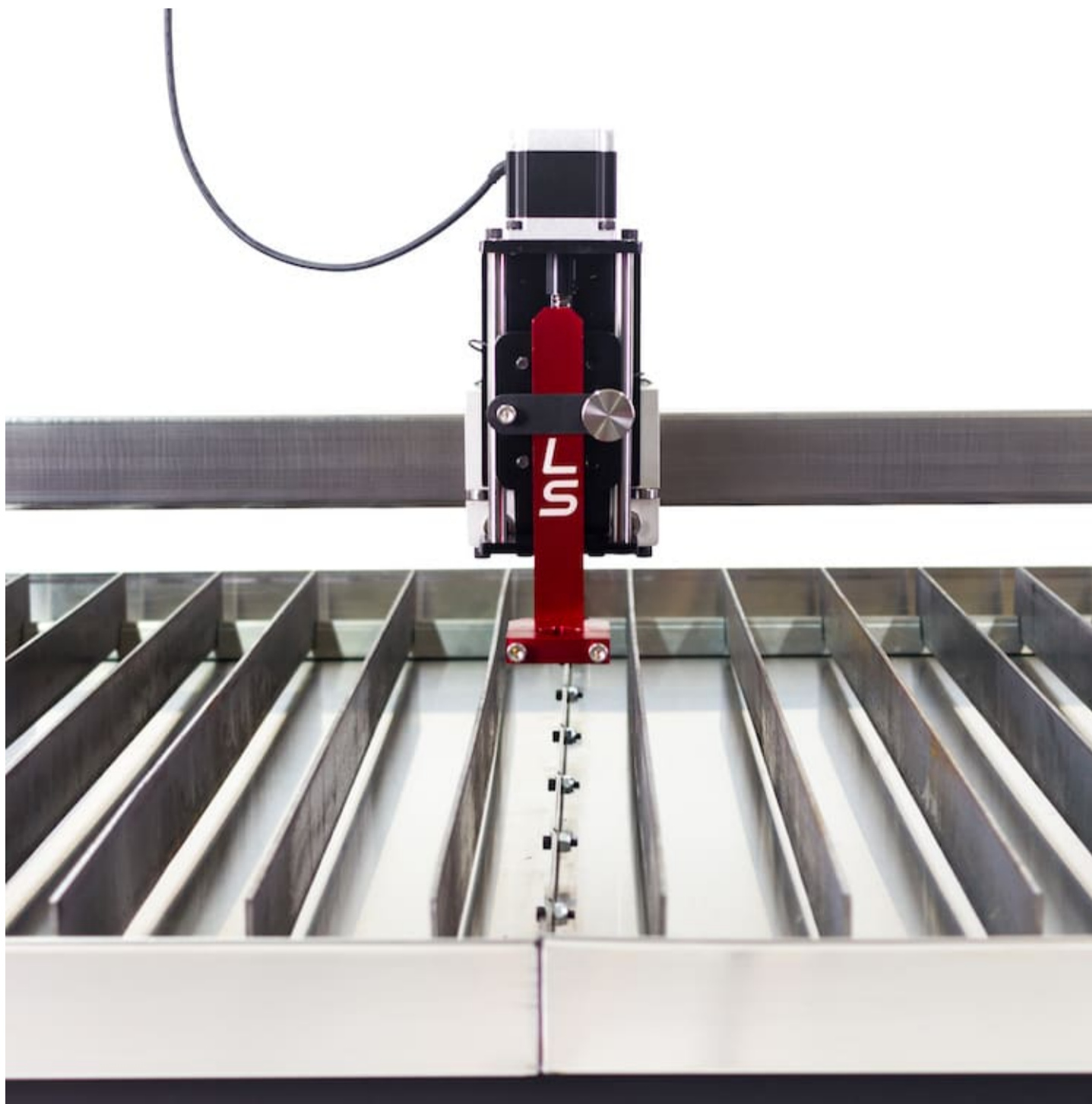

### Initial Height Sensing

Floating Z-Axis with Initial Height Sense for increased consumable lifetime and tip-up avoidance.



### THC Compatible

Electronics and software are Plug-n-Play with add-on Auto Torch Height Control module.



## THE CROSSFIRE TURNED PRO

You asked and *we listened*. The CrossFire **PRO** features a production ready 48.25" x 33.3" cutting area, powered Z-axis with Initial Height Sense, reinforced steel frame w/ integrated stainless water table, and Torch Height Control compatibility. Bring industrial capabilities to your shop with a machine that wont quit.



## REINFORCED STEEL FRAME

Whether you're cutting sheet metal signage or 1" steel parts for heavy fab, the **PRO** has got you covered. The 230 lb frame features structural steel tubing and gusseted joints for maximum rigidity.



## STAINLESS STEEL

# WATER TABLE

The large stainless water table that comes standard on the **PRO** ensures that your material stays cool when cutting and keeps fumes down. With sub-flush edges, you can now slide full width sheets through the machine slat surface.

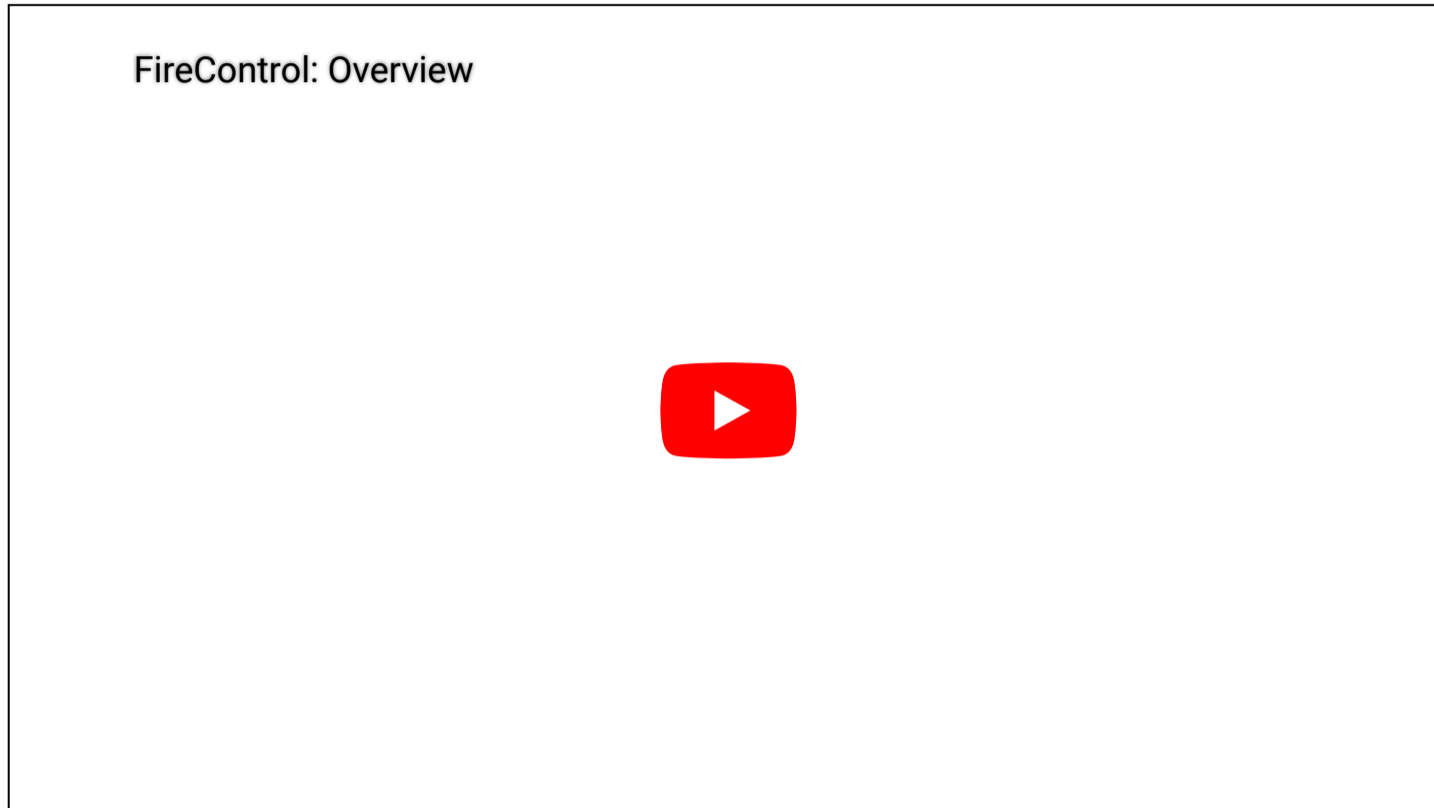

## POWERFUL CONTROL SOFTWARE

Unlike other CNC Plasma manufacturers, Langmuir Systems develops its own machine control software, **FIRECONTROL**. This allows us to regularly release updates and new features with CrossFire Customer suggestions. Watch this overview to see how FireControl works.

Learn more about FireControl → (</firecontrol>)



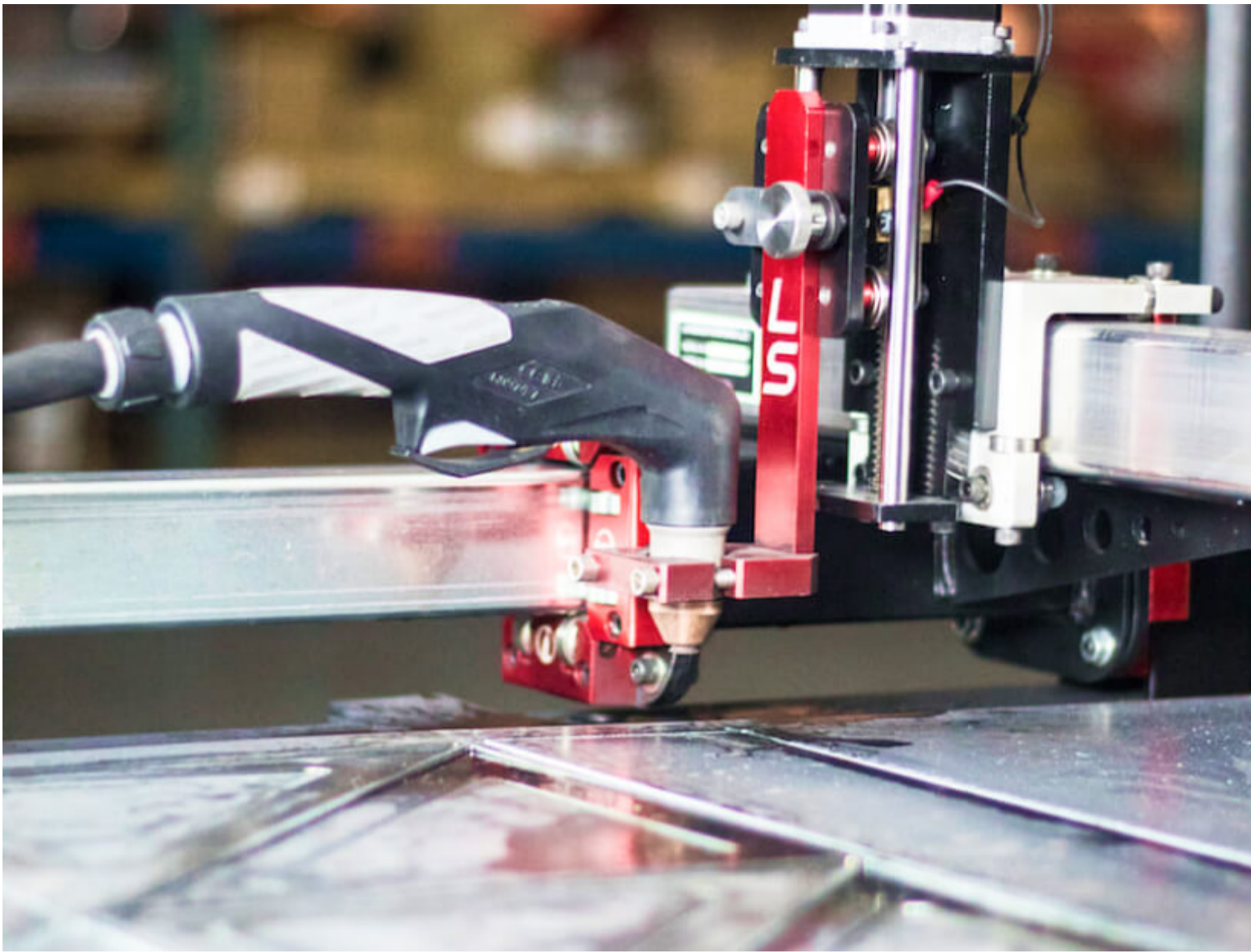

## From the makers of the CROSSFIRE

Don't take our word for it- Check what our customers have to say about the CrossFire CNC. Join the growing community today.

[Read Customer Reviews → \(/reviews\)](/reviews)



## IGNITE YOUR BUSINESS

Stop outsourcing your cutting needs and put a production capable machine in your shop at a fraction of the price.

Sign up to be notified of future CrossFire® Store promotions.

Email Address

---

Notify Me



## MACHINE COMPARISON

Langmuir Systems offers powerful, affordable, and well-supported CNC Plasma machines for all different use cases. See what CNC Plasma can do and transform your fabrication process today.

[More about CNC Plasma →\(/plasma\)](/plasma)



[Compare Machines\(/compare\)](/compare)

## CROSSFIRE® PRO SPECIFICATIONS

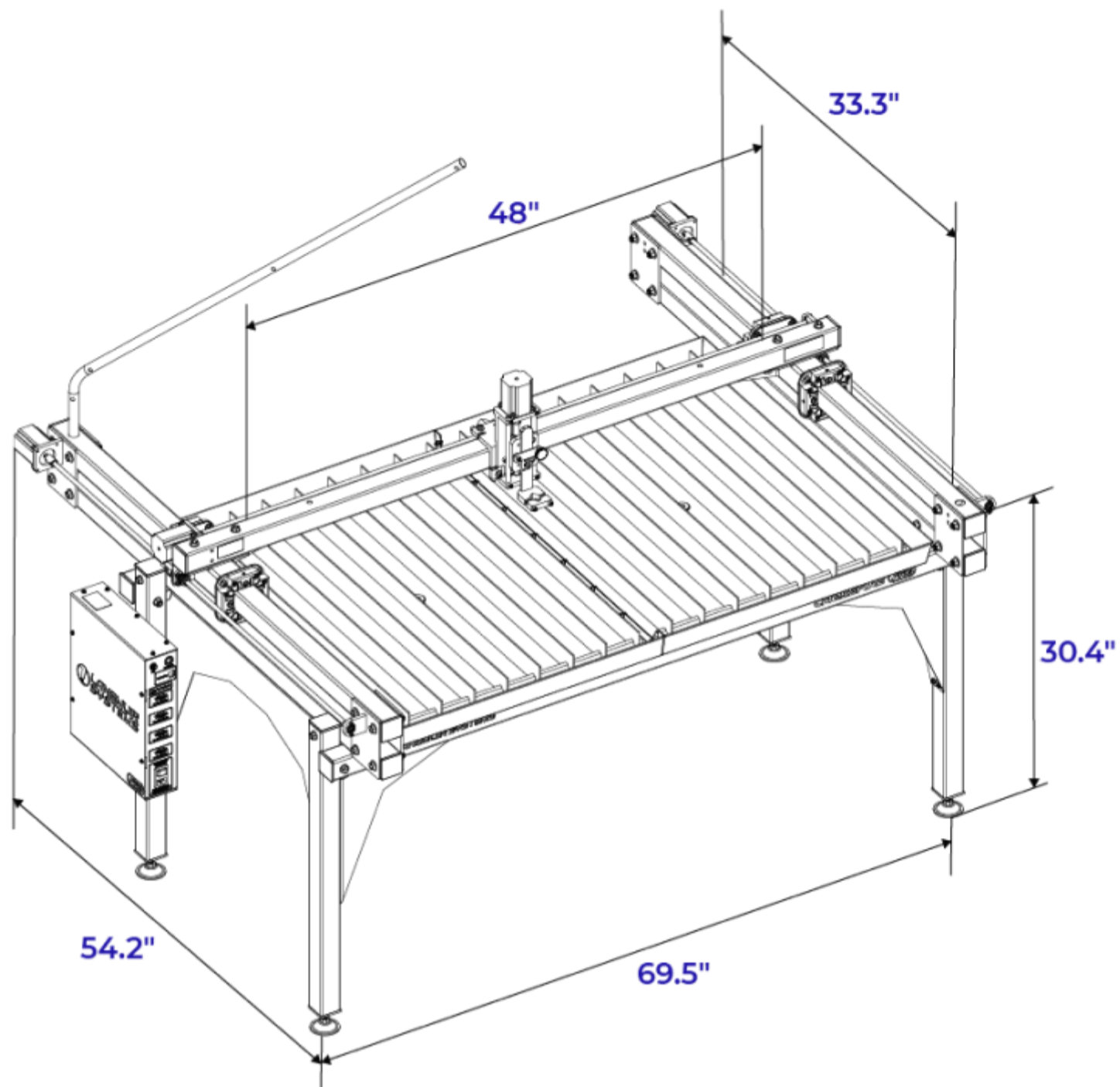

### Cutting Envelope Dimensions:

48.25" (X) x 33.3" (Y) x 2.75" (Z) + 3" Manual Height Adjustment

### Machine Weight:

223 Pounds

### Linear Bearing Type:

Ball Bearing Carriages on Zinc-plated Steel Tube Rails

### Stepper Motor Size:

NEMA 23; X-Axis 284 oz-in, Y-Axis (2) 284 oz-in, Z-Axis 180 oz-in

### PC Interface:

Windows USB

### Mechanical Drive System:

3/8"-8 4-Start ACME Lead Screws and Acetal Anti-Backlash

Lead Nuts, 1/2" 5-Start Lead Screw (X)

**Motion Accuracy:**

0.002" per 12" inches

---

**Step Resolution:**

0.0005"

---

**Maximum Cut Speed:**

300 ipm

---

**Table Surface:**

Replaceable Steel Slats, 50mm wide x 3mm thick

---

**Input Power:**

110/220 VAC (selectable)

---

**Torch Height Control:**

Powered Z Axis with Floating Head Torch Mount and Initial Height Sensing. THC Compatible

**MORE OF  
THE PRO**



langmuirsystems.com/img/pro-assets/gallery/gallery1.jpg)



langmuirsystems.com/assets/langmuirsystems.com

< 2 / 11 >

## PRO FAQ

- What is the cutting area of the CrossFire PRO? +
- Is the machine expandable to 4' x 8'? +
- Can I finance the purchase of the CrossFire PRO? +
- What are the electrical requirements? +
- What is included? +

Can I fit full sheets of metal on my CrossFire PRO?	+
What is Initial Height Sensing (IHS)? Does it cost extra?	+
What is automatic Torch Height Control (THC)?	+
Do I need to purchase the automatic Torch Height Control (THC) add-on?	+
Can I add electronic accessories to this machine?	+
Can I use my CrossFire PRO as a wood router?	+
Can I purchase add-on accessories at a later date?	+
What Plasma Cutters are compatible with the CrossFire PRO?	+
What is the maximum plate thickness that can be cut on this machine?	+
How can I purchase replacement parts for this machine?	+
Can I upgrade my CrossFire or CrossFire XL to a PRO?	+
How does the PRO ship?	+
What is the Warranty on the CrossFire PRO CNC Plasma Table?	+
What is the Return and Refund Policy for the CrossFire PRO CNC Plasma Table?	+
More questions?	+