

ORDER THE CROSSFIRE CNC PLASMA



25.3" x 23.3" CNC Plasma Table, perfect for the garage or small business.

CROSSFIRE CNC ESTIMATED SHIPPING IN **2-3 WEEKS**.









Included:

What to Expect → (/what-to-expect)

- 
CrossFire Personal CNC Plasma Table **\$1495**
 Complete ready-to-assemble CNC Plasma Machine.
- 
FireControl CNC Control Software
 Developed to control the CrossFire line of CNC Machines.
- 
Autodesk Fusion 360 CAD/CAM Software
 Powerful CAD/CAM Software that is Free for personal (non-commercial) and educational use.

Add-ons:

- 
XL Expansion Kit **\$150**
 The CrossFire XL expansion adds 10" of travel for a total work area of 25.3" x 33.3", a 44% increase.
- 
Z-Axis Upgrade Kit (includes Z-Axis, THC, IHS) **\$550**
 Upgrade your CrossFire with the Z-Axis, IHS, and THC kit for Gen2 CrossFire CNC Plasma Machines. Learn More about THC (<https://www.langmuirsystems.com/thc/guide>).
- 
Water Table **\$150**
 A drop-in Stainless Steel water table for your CrossFire or CrossFire XL machine.
- 
Laptop Stand **\$85**
 Steel adjustable laptop stand keeps your computer conveniently close to your CrossFire.
- 
Razorweld 45 CNC Plasma Cutter **\$995**
 45 Amp, 1/2" Steel Cut Capacity, Custom Plug N Play CNC Port, and X45 Torch. Or use your own (/plasma-cutters).
- 
Razorweld 45 CNC Plasma Cutter with Machine Torch **\$1170**
 45 Amp, 1/2" Steel Cut Capacity, Plug-N-Play CNC Port, X45 Machine Torch, & required Machine Torch Mount (<https://store.langmuirsystems.com/collections/add-ons/products/crossfire-crossfire-pro-machine-torch-mount>).
- 
NEW! Hypertherm 45 XP with Machine Torch **\$2775**
 45 Amp, 5/8" Steel Cut Capacity, CPC Port, with Machine Torch Mount (<https://store.langmuirsystems.com/collections/add-ons/products/crossfire-crossfire-pro-machine-torch-mount>) and CPC Cable (<https://store.langmuirsystems.com/collections/add-ons/products/hypertherm-cpc-cable-for-crossfire-crossfire-pro-cnc>). [More Info →](#)
[/assets.langmuirsystems.com/file/hypertherm/Hypertherm_45XP.pdf](https://assets.langmuirsystems.com/file/hypertherm/Hypertherm_45XP.pdf)

\$1495

+\$149 flat rate shipping to contiguous USA.
Shipping 2-3 weeks

ORDER NOW([https://store.langmuirsystems.com/cart/6794763042858:1](https://store.langmuirsystems.com/cart/6794763042858:1;)),

Starting at \$94/mo with [affirm](#). Prequalify now



THE ULTIMATE FABRICATION TOOL

Cut your intricate digital designs faster and more accurately than any other metalworking power tool. Create projects with some of the world's strongest and most durable materials. From automotive parts, to real structural components, to weatherproof art and signage.



Crossfire integrates seamlessly with the design software, workflows, and file formats you already use. Users can also select from Langmuir System's online library of designs (/fireshare) or design something new.

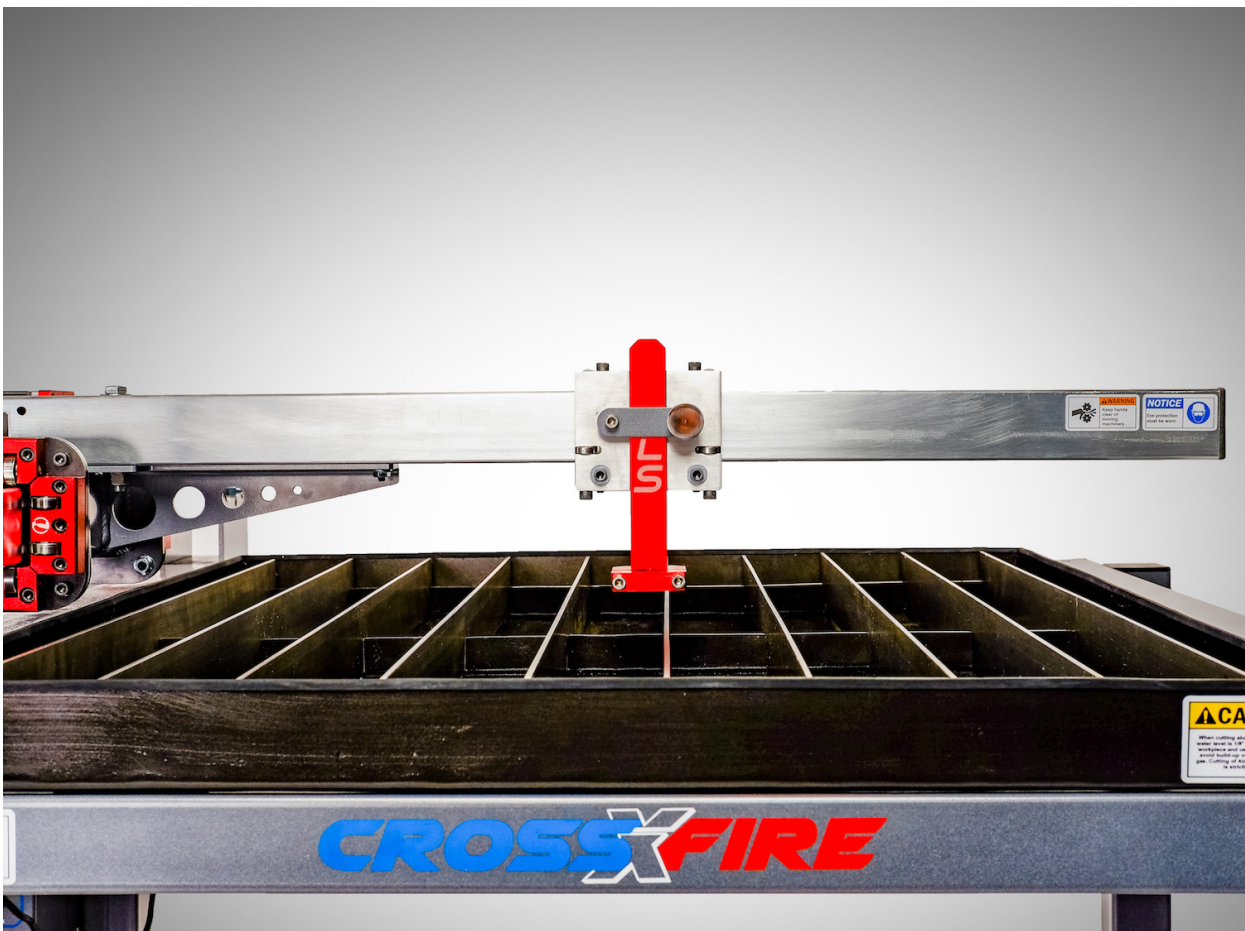

LARGE SCALE, SMALL PACKAGE

An exclusively industrial fabrication process is now small and affordable enough to operate in your home garage. Roll the machine into your work area and store away when not in use. Open cantilever table design capable of cutting material you would otherwise need a much larger machine to cut.



EASY TO USE

Unlike traditional subtractive manufacturing methods, CNC plasma cutting does not require complicated fixturing and setup. Simply set your torch height and run the program.

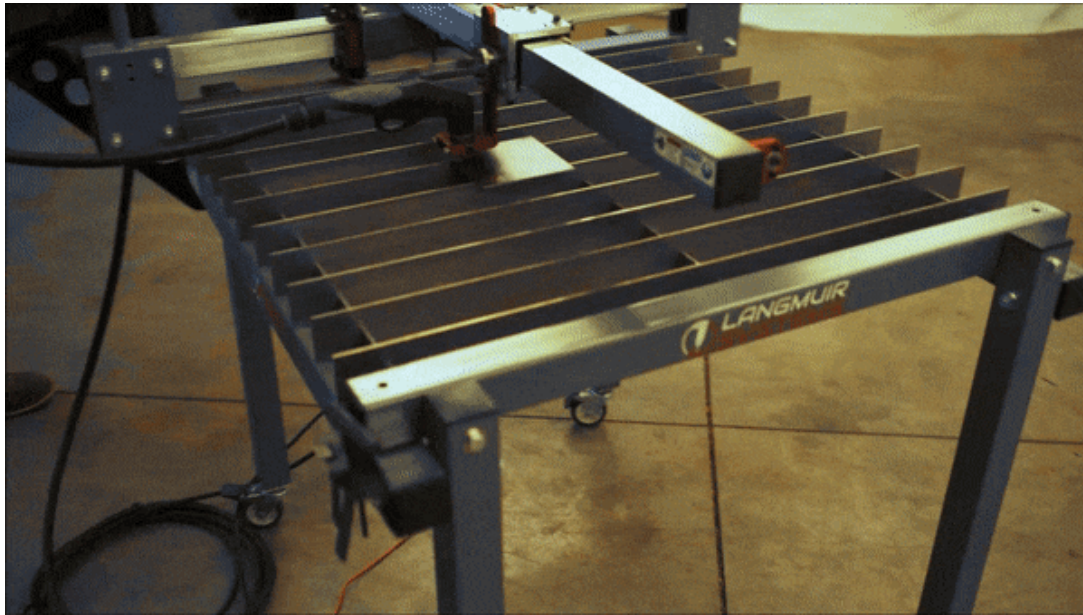

FAST CUT SPEED

Put one of the fastest industrial metal cutting processes right in your home garage or shop. With cut speeds of up to 300 inches per minute, the CrossFire will bring production level output to your personal projects.

FireControl: Overview



POWERFUL CONTROL SOFTWARE

Unlike other CNC Plasma manufacturers, Langmuir Systems develops its own machine control software, **FIRECONTROL**. This allows us to regularly release updates and new features with CrossFire Customer suggestions. Watch this overview to see how FireControl works.

Learn more about FireControl → (</firecontrol>)

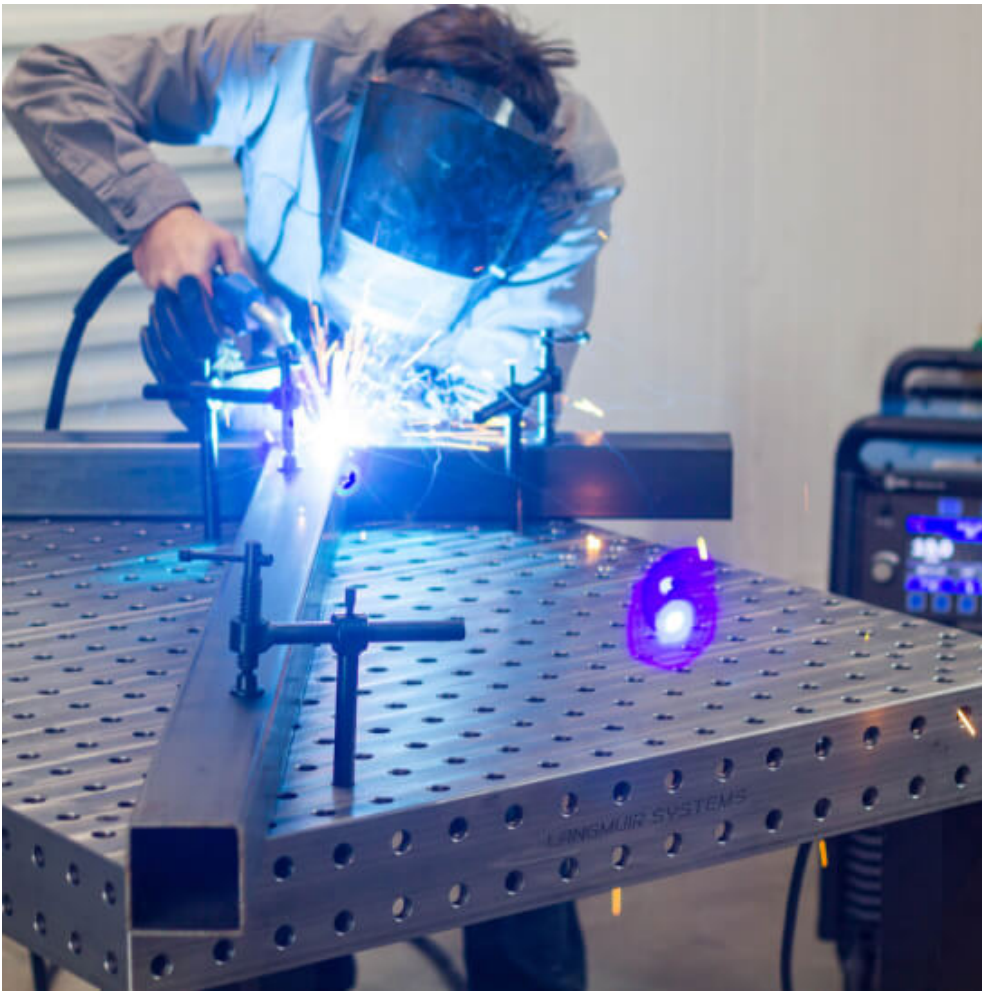

DON'T TAKE OUR WORD FOR IT

See what our customers have to say about the best-selling CrossFire CNC Plasma. Join the growing community today.

[Read Customer Reviews → \(/reviews\)](/reviews)



IGNITE YOUR BUSINESS

Stop outsourcing your cutting needs and put a production capable machine in your shop at a fraction of the price.

Sign up to be notified of future CrossFire® Store promotions.

Email Address

Notify Me



MACHINE COMPARISON

Langmuir Systems offers powerful, affordable, and well-supported CNC Plasma machines for all different use cases. See what CNC Plasma can do and transform your fabrication process today.

[More about CNC Plasma →\(/plasma\)](#)

[Compare Machines\(/compare\)](#)

CROSSFIRE™ SPECIFICATIONS

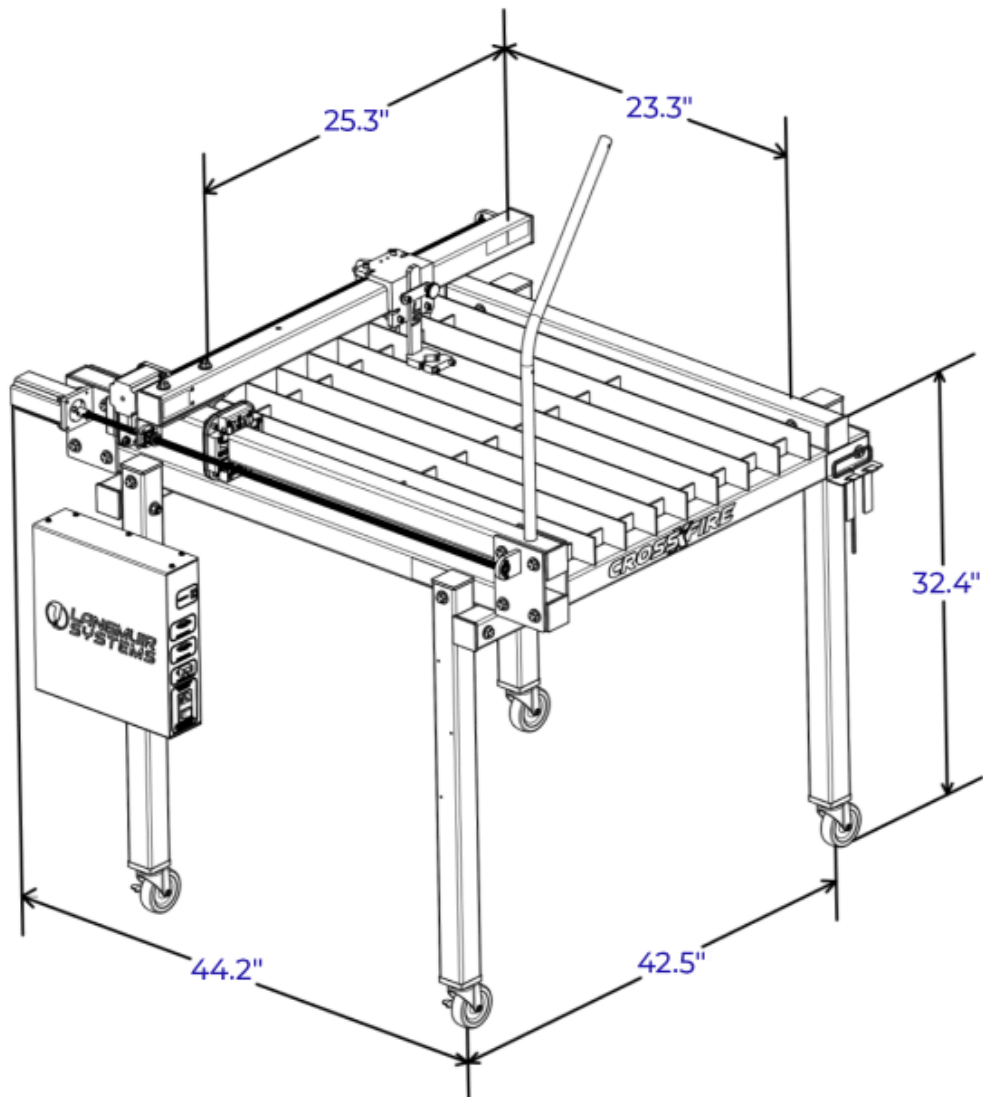

Cutting Envelope Dimensions:

25.3" (X) x 23.3" (Y) x 3.0" (Z)

Machine Weight:

130 Pounds

Linear Bearing Type:

Ball Bearing Carriages on Zinc-plated Steel Tube Rails

Stepper Motor Size:

X-Axis 284 oz-in Y-Axis 425 oz-in

PC Interface:

Windows USB

Mechanical Drive System:

3/8"-8 4-Start ACME Lead Screws and Acetal Anti-Backlash Lead Nuts

Motion Accuracy:

0.002" per 12" inches

Step Resolution:

0.0005"

Maximum Cut Speed:

300 ipm

Torch Height Control:

Manual Torch Height Adjustment

Table Surface:

Replaceable Steel Slats, 50mm wide x 3mm thick

Input Power:

110/220 VAC (selectable)

WHAT #LANGMUIRSYSTEMS ([HTTPS://WWW.JUICER.IO/LANGMUIRSYSTEMS](https://www.juicer.io/langmuirsystems)) CUSTOMERS ARE MAKING

 Photo from #langmuirsystems on Instagram on null at 10/28/22 at 9:25PM

 Photo from #langmuirsystems on Instagram on null at 10/28/22 at 7:29PM

 Photo from #langmuirsystems on Instagram on null at 10/28/22 at 8:07AM

 Photo from #langmuirsystems on Instagram on null at 10/28/22 at 5:04AM

(<https://www.instagram.com/p/CkRATLEufOs/>)

♡ 1
(<https://www.instagram.com/p/CkRATLEufOs/>)

(<https://www.instagram.com/p/CkRATLEufOs/>)

 Photo from #langmuirsystems on Instagram on null at 10/28/22 at 12:56AM

(https://www.instagram.com/p/CkQy_vsLJQ1/)



(https://www.instagram.com/p/CkQy_vsLJQ1/)

 Photo from #langmuirsystems on Instagram on null at 10/28/22 at 12:43AM

 1
(<https://www.instagram.com/p/CkPk-kQOLyj/>)

♡ 5
(<https://www.instagram.com/p/CkPk-kQOLyj/>)



(<https://www.instagram.com/p/CkPk-kQOLyj/>)

 Photo from #langmuirsystems on Instagram on null at 10/27/22 at 11:27PM

(<https://www.instagram.com/p/CkPQF0NJOEF/>)

♡ 7
(<https://www.instagram.com/p/CkPQF0NJOEF/>)

(<https://www.instagram.com/p/CkPQF0NJOEF/>)

 Photo from #langmuirsystems on Instagram on null at 10/27/22 at 9:23PM

(<https://www.instagram.com/p/CkOyMTSOAmB/>)

(<https://www.instagram.com/p/CkOzpQfuM7T/>)

♡ 1
(<https://www.instagram.com/p/CkOzpQfuM7T/>)

📷
(<https://www.instagram.com/p/CkOzpQfuM7T/>)

♡ 7
(<https://www.instagram.com/p/CkOyMTSOAmB/>)

📷
(<https://www.instagram.com/p/CkOyMTSOAmB/>)

(<https://www.instagram.com/p/CkOpcCrPMyo/>)

♡ 5
(<https://www.instagram.com/p/CkOpcCrPMyo/>)

📷
(<https://www.instagram.com/p/CkOpcCrPMyo/>)

♡ 2
(<https://www.instagram.com/p/CkObVJfJ5gf/>)

📷
(<https://www.instagram.com/p/CkObVJfJ5gf/>)

More Customer Posts > (<https://www.juicer.io/langmuirsystems>)

CROSSFIRE FAQ

What is the cutting area of the CrossFire? +

What is Included? +

Can I finance the purchase of the CrossFire? +

What are the electrical requirements? +

Can I fit full sheets of metal on my CrossFire? +

Can I add electronic accessories to this machine? +

Can I use my CrossFire as a wood router? +

Can I purchase add-on accessories at a later date? +

What Plasma Cutters are compatible with the CrossFire? +

What is the maximum plate thickness that can be cut on this machine? +

How can I purchase replacement parts for this machine? +

How does the CrossFire ship? +

What is the Warranty on the CrossFire CNC Plasma Table? +

What is the Return and Refund Policy for the CrossFire CNC Plasma Table? +

More questions? +
