

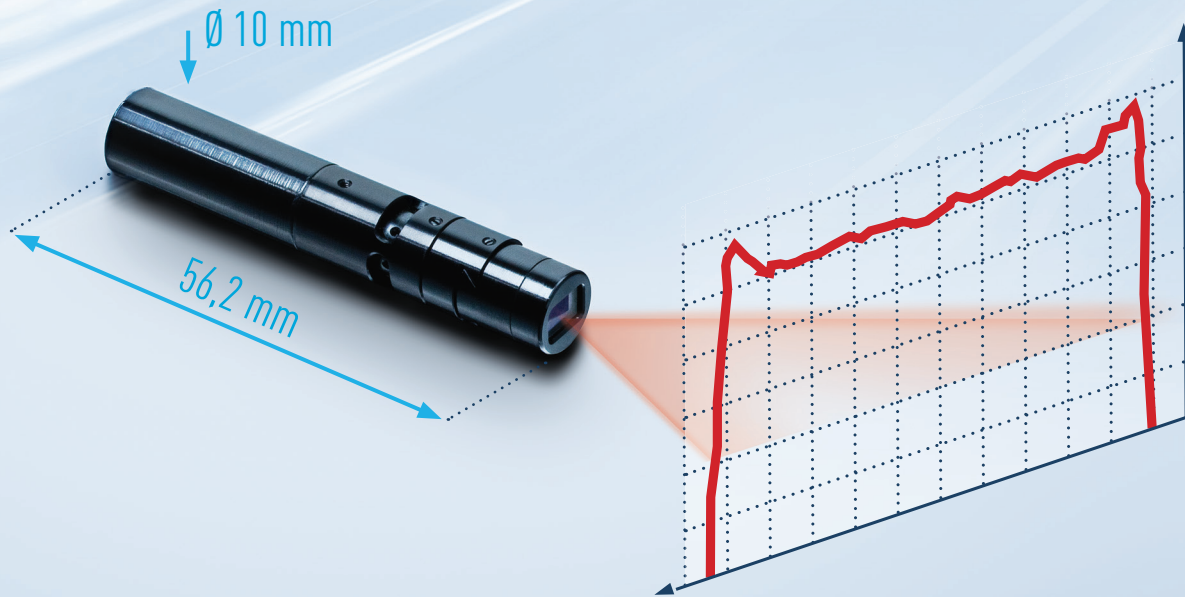

STRUCTURED LIGHT AND
LASER BEAM SHAPING SOLUTIONS

COMPACT LASER MODULE

High performance, high reliability with superior beam shaping capabilities in a self contained compact laser module for demanding industrial applications.



FEATURES

- Compact, 10mm Diameter
- Externally focusable
- Superior beam shaping
- High Pointing stability
- ESD & Over temperature protected
- Up to 2 year warranty

APPLICATIONS

- Industrial Inspection
- Machine Vision
- Positioning

LASER DIODE MODELS AND FOCUSING OPTIONS

At Osela we provide many different focusing options giving you the flexibility to choose the one that best suits your application. The Compact laser is free focusable externally without removing any optics. From the graphs below, note the beam size and Depth of Focus (DOF) values and then multiply by the K constants for the laser diode model and focus option of choice (A, B, C, D or E).

Example: From the graphs at 400 mm working distance, Focus = 140µm, DOF = 36 mm. Then for Laser Model 660 nm 100 mW the line thickness at focus for OPTION A will be 212µm (i.e. 140 µm x 1.52). Its depth of focus will be 88.92mm (i.e. 36mm x 2.47).

SHORT RANGE

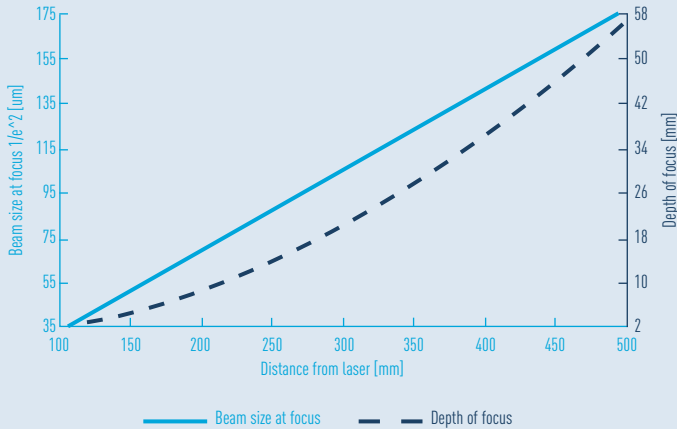

LONG RANGE

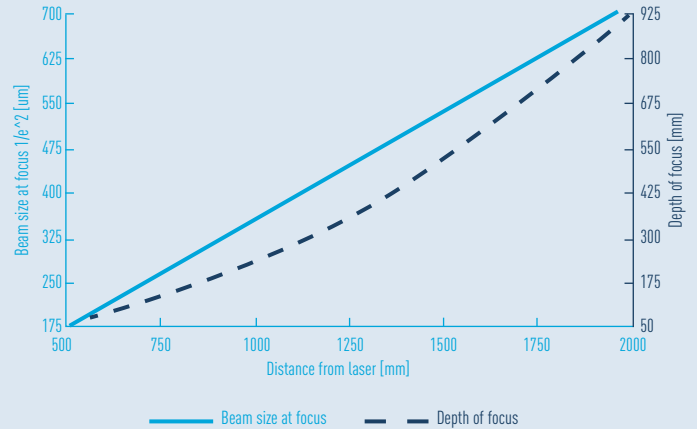

DIODE MODEL			OPERATING CURRENT ² (mA)	FOCUSING & DOF CONFIGURATION AND CONSTANT							
WAVELENGTH BAND (nm)	DIODE POWER (mW)	WAVELENGTH TOLERANCE (nm)		TYPE A		TYPE B		TYPE D		TYPE E	
				K _{FOCUS}	K _{DOF}	K _{FOCUS}	K _{DOF}	K _{FOCUS}	K _{DOF}	K _{FOCUS}	K _{DOF}
405 ¹	35	+5/-5	35	0.68	0.80	1.65	4.74	0.98	1.69	2.39	10.00
450 ¹	100	+10/-10	100	0.66	0.69	1.95	6.00	0.96	1.45	2.83	12.65
520 ¹	50	+10/-5	145	0.74	0.75	2.80	10.77	1.07	1.58	4.06	22.69
635	5	+5/-5	50	0.79	0.70	2.58	7.44	1.15	1.47	3.75	15.67
	10	+8/-4	55	0.96	1.02	2.58	7.44	1.39	2.15	3.75	15.67
640	25	+3/-10	80	0.96	1.02	2.29	5.86	1.39	2.15	3.33	12.35
	45	+5/-5	100	0.96	1.02	2.06	4.73	1.39	2.15	2.99	9.98
650	5	+10/-5	48	0.73	0.56	2.38	6.09	1.05	1.19	3.46	12.84
	10	+10/-5	55	0.73	0.56	2.26	5.46	1.05	1.19	3.27	11.51
660	35	+5/-10	90	0.95	0.96	2.52	6.84	1.37	2.02	3.66	14.41
	50, 100, 130	+5/-5	120, 160	1.52	2.47	2.14	4.92	2.20	5.22	3.11	10.37
690	35	+5/-10	95	1.15	1.36	2.62	7.10	1.66	2.87	3.80	14.96
	50	+10/-10	150	1.09	1.22	2.11	4.63	1.58	2.57	3.07	9.75
785	75, 120	+10/-10	150, 200	1.57	2.23	2.83	7.25	2.28	4.71	4.11	15.27
830	50	+10/-10	115	1.19	1.21	3.00	7.66	1.73	16.14	4.35	16.14

- C focus option (Kfocus = 0.85, KDOF = 0.41) also available for 660 nm 50 mW and 660 nm 100 mW lasers.

¹ 9 to 30V operation

² Measured at 25°C at operating voltage of 5V for ≥635nm and 12V for 405, 450 and 520nm models)

MODULATION

The Compact laser can be modulated by an external 0 to 5V TTL signal via the white wire. The "T" type modulation is the default input for the Compact laser module.

MODULATION	CODE	ON	OFF
TTL (default)	T	0 to 0.5V	0.7 to 5V
Reverse TTL	RT	0.7 to 5V	0 to 0.5V

Optional: Linear power adjustment on fourth wire, option "V".

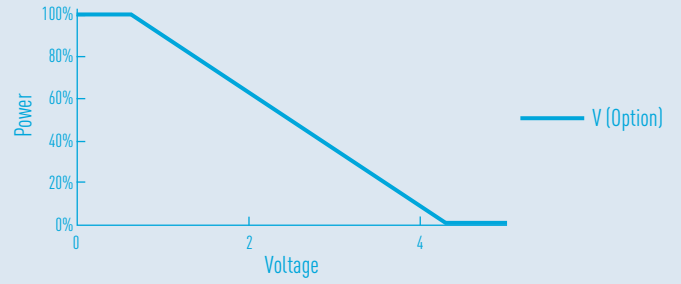

SPECIFICATIONS

Bore sight (mrad)	< 3 mrad
Wavelength Drift	≈ 0.25 nm/ degC
Pointing Stability	< 6 μrad/°C
Rise/Fall time	< 5μ sec, 100% modulation depth (10 Kohm impedance)
Protections (Built in)	ESD, Over voltage (up to 30 VDC), Over-temp Shutoff (> 45 deg C)
Long term Power stability (8 hours)	< 3 %, 2 minute warm up time
Operating Voltage	5 ± 0.5VDC, 4.5 to 30V Optional (9-30V for < 635 nm)
Working Temp Range	-10 to to +45 °C (housing)
Weight	< 20 g
Power Supply Cable	18 inches 3 conductors with flying leads

MECHANICAL SPECIFICATIONS

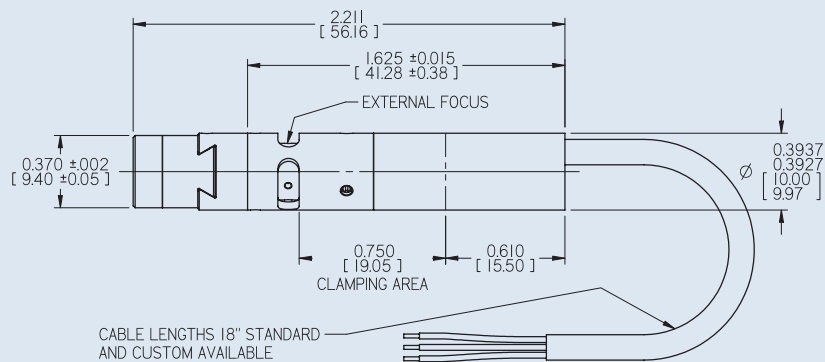

COMPACT SINGLE LINE GENERATOR

FIG 1 - INTENSITY DISTRIBUTION ALONG THE LINE

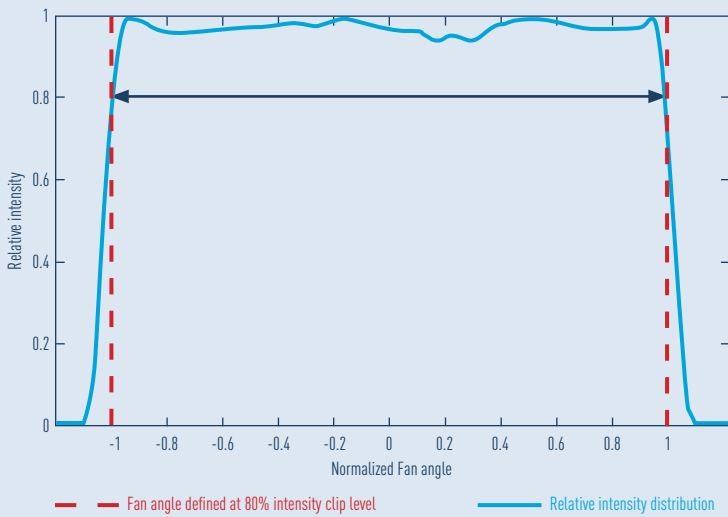
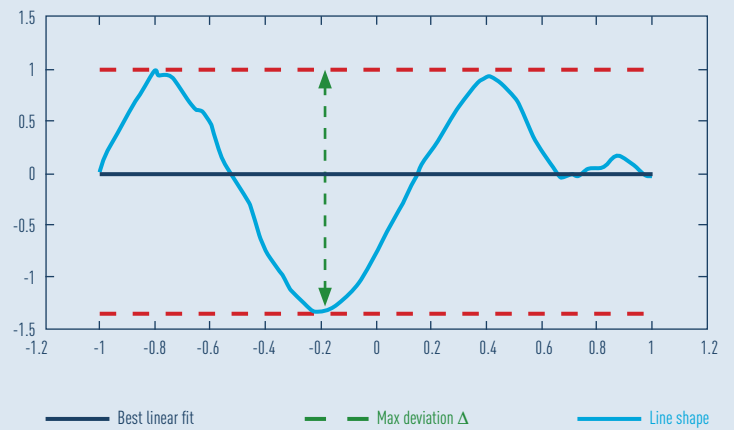

FIG 2 - LINE STRAIGHTNESS



SPECIFICATIONS

SPECIFICATIONS		VALUES
Uniformity (line intensity distribution along the line) ¹	$\frac{I_{max} - I_{min}}{I_{max} + I_{min}}$	20% (typical)
Relative intensity clip that defines the fan angle		80%
Contained energy In the fan angle	$\frac{\text{Energy in fan angle}}{\text{total energy}}$	$\geq 95\%$
Line Straightness (deviation from the best linear fit)	$\frac{\Delta}{L \text{ (line length)}}$	$\leq 0.1\%$
Fan angle		1 to 90° ²
Fan angle tolerance (line diverging angle from the exit of the laser housing)		+1.0/-0.5° (FA <30°) +1.5/-0.5° (FA ≥30°)

¹ Uniformity and straightness are measured at 80% of the fan angle.

² Available Fan Angle (°) 1, 5, 10, 15, 20, 30, 38, 45, 60, 75, 90 custom upon demand.

ORDERING CODE

CL	-	XXX	-	XXX	-	X	X	-	XX	-	XXX-XX	-	XXXX
		Wavelength		Diode Power		Electronic	Focusing Option		Fan Angle		Multi beams		Option
		see table		see table		T	A		1, 5, 10		(Optional)		SD:
						RT	B		15, 20		Refer to the		Separate
						D	C		30, 38		Multi-dots and		Driver
							D		45, 60		Multi-Lines		24V
							E		75, 90		page		