

IXION 193

TEM₀₀ beam profile
Diode laser pumped
Q-Switched solid-state laser
Single-frequency wavelength 193.368 nm

General description

The IXION 193 SLM is a single-frequency all-solid-state laser system for applications such as optical metrology, calibration of 193 nm stepper optics or bandwidth control of high power ArF excimer lasers. The spectral bandwidth of less than 80 MHz is near its theoretical Fourier limit.

The center wavelength of the system is customizable in a range between **185** and **194 nm** and can be pre-configured to a fixed wavelength at the time of purchase.

As an option a high precision spectrometer with an absolute spectral accuracy of 0.001 nm is integrated into the system. This allows maximum control of the spectral tuning of the laser.

Product specifications

Model	IXION 193 SLM
Wavelength	193.368 nm
Average power	10 mW
Pulse duration (typ)	8-12 ns
Energy per pulse	1.6 μJ
Repetition rate	1-15 kHz
M ²	< 1.6
Spectral bandwidth	80 MHz ⇔ 0.01 pm ⇔ 0.0027 cm ⁻¹
Coherence length ¹⁾	> 2 m
Spectral tunability	> 80 GHz ⇔ 10 pm ⇔ 2.6 cm ⁻¹

1) 50% contrast
 Data at 6 kHz pulse repetition rate.
 Specifications are subject to change
 without notice due to product improvement.

Applications

- Spectrometer calibration
- Lithography
- Interferometry
- 193 nm metrology
- Injection seeding of Excimer lasers

Optional

- Graphical user interface
- LabVIEW libraries
- Precision spectrometer
- Center wavelength: between 185-194nm
- CDRH compliance shutter

Distribution in the UK & Ireland



**Characterisation,
 Measurement &
 Analysis**

Lambda Photometrics Limited
 Lambda House Batford Mill
 Harpenden Herts AL5 5BZ
 United Kingdom
 E: info@lambdaphoto.co.uk
 W: www.lambdaphoto.co.uk
 T: +44 (0)1582 764334
 F: +44 (0)1582 712084

Typical performance

Wavelength stability

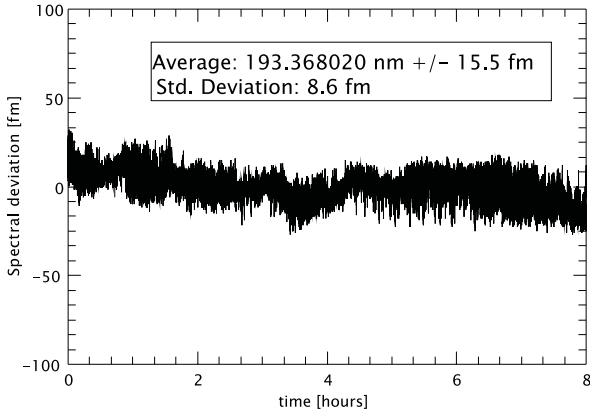

Beam profile

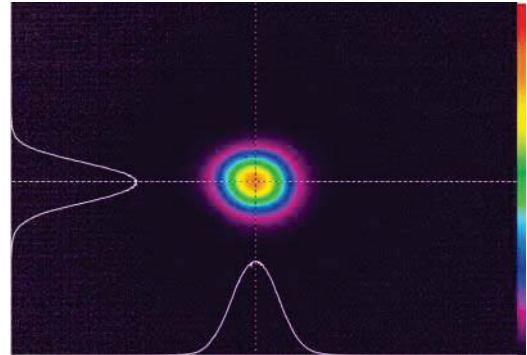

Spectral characterizatoin

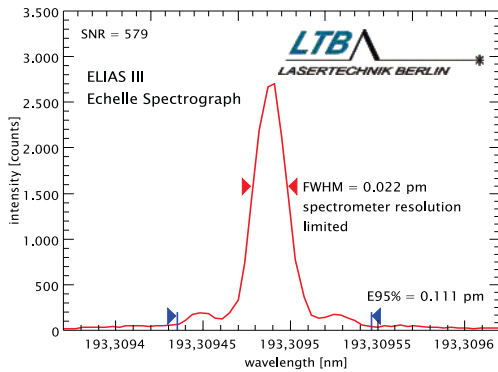

Long term stability

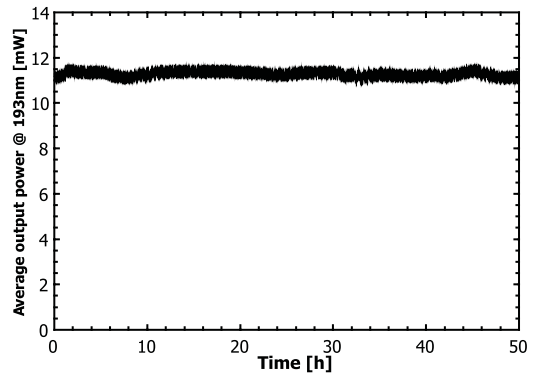

Dimensions laser head

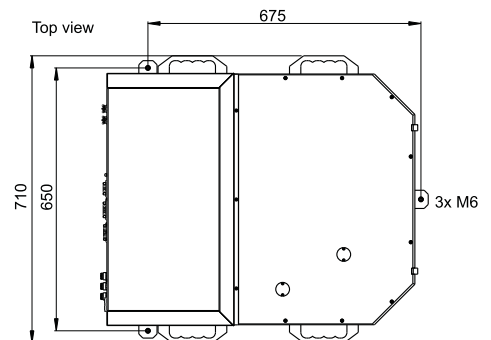
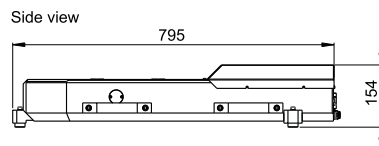
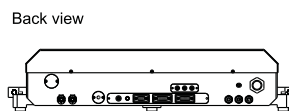
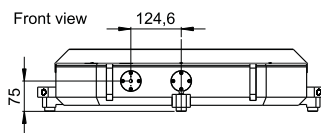

System dimensions (L x W x H), weight

Laser head	795 x 710 x 154 mm ³	74 kg
Power supply (including chiller)	600 x 600 x 600 mm ³	78 kg

Electrical characteristics

Operating voltage	85-264 VAC
Frequency	47-63 Hz
Power consumption	650 W typ

Visible and/or invisible laser radiation. Avoid eye or skin exposure to direct or scattered radiation.
Class 4 laser (IEC 60825-1)



Distribution in the UK & Ireland



**Characterisation,
Measurement &
Analysis**

Lambda Photometrics Limited
Lambda House Batford Mill
Harpenden Herts AL5 5BZ
United Kingdom
E: info@lambdaphoto.co.uk
W: www.lambdaphoto.co.uk
T: +44 (0)1582 764334
F: +44 (0)1582 712084