

UV-VIS-NIR Spectrophotometer

UV-3600 Plus



Incorporating the latest technology to achieve high sensitivity, high resolution, and an ultra-low stray light level, leading the way to new solutions

UV-VIS-NIR Spectrophotometer

UV-3600 Plus



High Sensitivity

Shimadzu developed the world's first UV-VIS-NIR spectrophotometer with three detectors, consisting of a PMT (photomultiplier tube) for the ultraviolet and visible regions and InGaAs and cooled PbS detectors for the near-infrared region. With conventional instruments that use only PMT and PbS detectors, there is a drop in sensitivity in the crossover region between those detectors. Using an InGaAs detector to cover this crossover region, however, ensures high sensitivity across the entire measured wavelength range, and gives a noise level of 0.00003 Abs at 1500 nm.

In addition to the main UV-3600 Plus unit, the Multi-purpose large-sample compartment and the Integrating sphere attachment also feature three detector, enabling the high-sensitivity measurement of solid samples.

High Resolution, Ultra-Low Stray-Light, and Wide Wavelength Range

A high-performance double monochromator makes it possible to attain an ultra-low stray-light level (0.00005 % max. at 340 nm) with a high resolution (maximum resolution: 0.1 nm). The wide wavelength range of 185 to 3,300 nm enables measurement across the ultraviolet, visible, and near-infrared regions.

This instrument can perform spectrophotometry for a variety of applications.

The Advantages of Double-Grating Monochromators

The UV-3600 Plus uses gratings for both the pre-monochromator and main monochromator. Our holographic diffraction gratings are designed to achieve high efficiencies and exceptionally low stray-light levels. Furthermore, to improve light energy efficiency, blazed gratings are used for wavelength regions that by nature have low light source energy or lower detector sensitivity. A G-G system that uses gratings for both the pre-monochromator and main monochromator ensures low stray light, with a constant optimal resolution of 0.1 nm in the ultraviolet and visible regions and 0.4 nm in the near-infrared region.

Wide Range of Optional Accessories

The three-detector Multi-purpose large-sample compartment or Integrating sphere options enable high-sensitivity measurement of solid samples. Use the ASR Series of absolute specular reflectance accessories to perform high-accuracy absolute reflectance measurements. In addition, temperature-controlled cell holders and micro cell holders are available to handle a wide range of measurement applications.



MPC-603 Multi-purpose large-sample compartment



150mm Large Integrating Sphere ISR-1503

High Sensitivity

The UV-3600 Plus provides precise transmittance or reflectance measurements in the ultraviolet to near-infrared regions. The level of sensitivity in the near-infrared region is significantly enhanced by using the combination of an InGaAs detector and a cooled PbS detector for this region. Spectra can be obtained without interruption for the entire range, with a high level of sensitivity and precision.

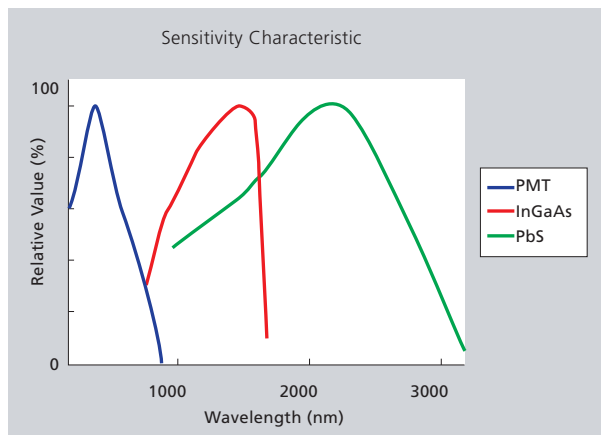
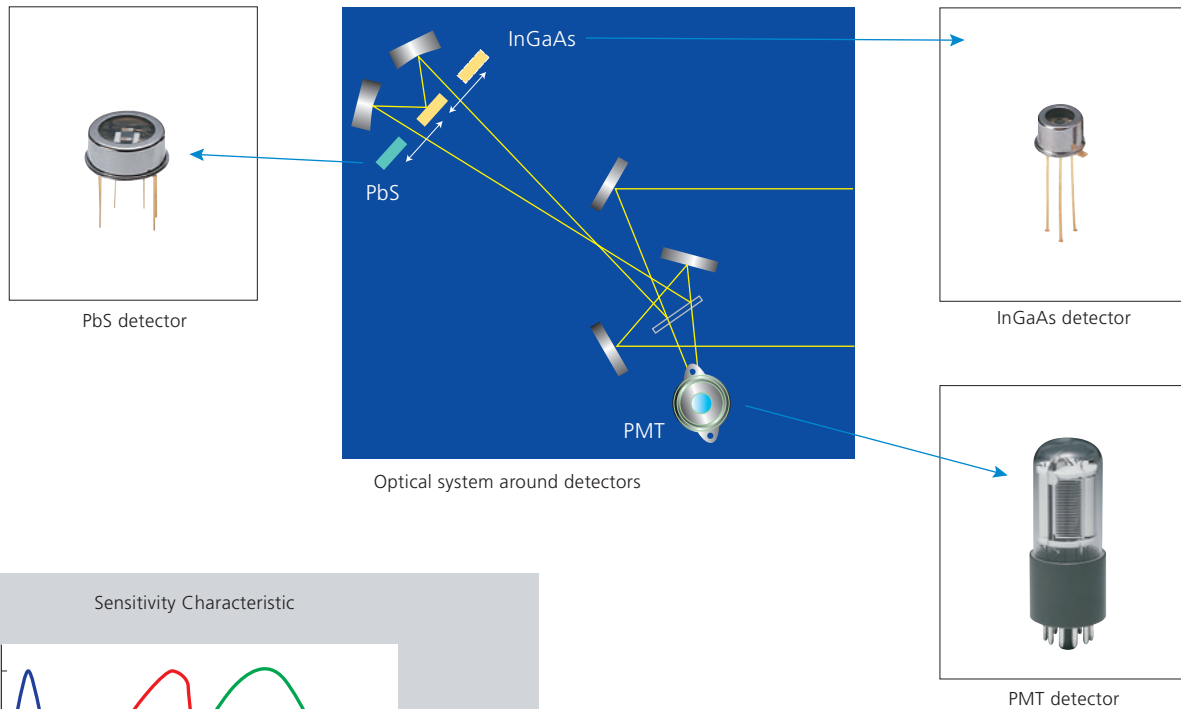

Some spectrophotometers use a PMT (photomultiplier tube) for the ultraviolet and visible region and a PbS detector for the near-infrared region. Neither detector, however, is very sensitive near the detector-switchover region. This prevents high-sensitivity measurement in this range. The UV-3600 Plus makes it possible to take high-sensitivity measurements in the switchover range by using an InGaAs detector.

Relationship between Detectors and Measurable Range

	165nm	380nm	780nm	3300nm
	UV		Visible	
	NIR			
PMT	165 to 1000 nm			
InGaAs		700 to 1800 nm		
PbS			1600 to 3300 nm	

Switching between the photomultiplier tube and the InGaAs detector is possible in the range of 700 to 1,000 nm (the default switchover wavelength is 830 nm). Switching between the InGaAs detector and the PbS detector is possible in the range of 1,600 to 1,800 nm (the default switchover wavelength is 1,650 nm).

Comparison between Two-Detector and Three-Detector Measurements

With the UV-3600 Plus, an InGaAs detector is used in addition to a PMT (photomultiplier tube) and a cooled PbS detector. This serves to significantly reduce the noise level in the InGaAs detector range (900 to 1,600 nm), in comparison to a conventional two-detector instrument (i.e., equipped with only PMT and a PbS detectors).

The figure on the right shows transmittance spectra for water measured with the UV-3600 Plus (InGaAs detector and cooled PbS detector) and a conventional instrument (PbS detector) in the range of 1,370 to 1,600 nm. The noise level is significantly less with the UV-3600 Plus. (A mesh filter is used on the reference-beam side to maintain balance with the sample-beam side.)

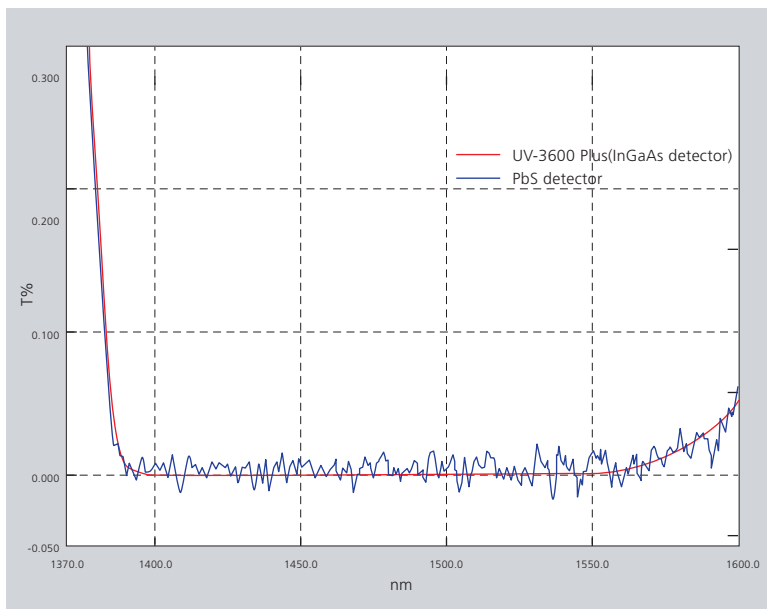

High-Accuracy Measurement with Minimized Detector Switchover Noise and Bump

Noise and bump caused by switching detectors is minimized to assure accurate measurement. Noise or bump is hardly observed even when using a transmission cell with a long optical path of 50 or 100 mm.

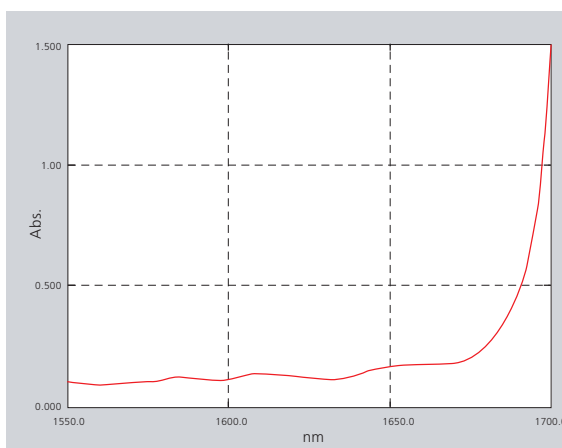
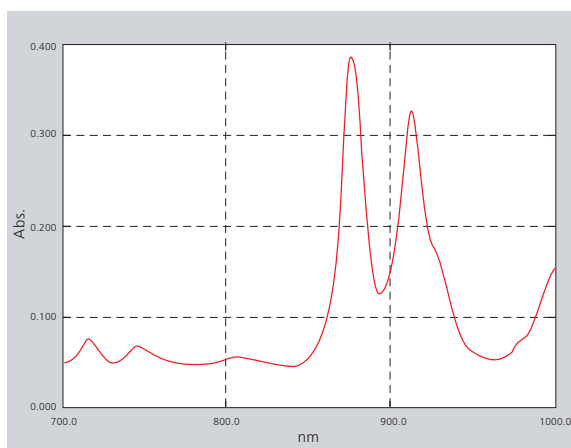

The figures above on the left and right are, respectively, transmittance spectra for ethylbenzene (obtained using a cell with an optical path of 100 mm) and cyclohexane (obtained using a cell with an optical path of 10 mm). No baseline change is observed at the detector changeover wavelengths (870 and 1,650 nm).

High Resolution, Low Stray-Light Level, and Wide Wavelength Range

The UV-3600 Plus is equipped with a high-performance, grating-grating double monochromator, and achieves a low stray-light level with high resolution. The wavelength range is 185 to 3,300 nm. This instrument can perform spectrophotometry for various types of samples, ranging from those requiring high resolution, such as gas samples, to highly concentrated liquid samples.

High-Resolution Spectra of Benzene Gas

The spectrum shown on the left was obtained by enclosing benzene gas in a cell with an optical-path length of 10 mm and performing measurement. The spectral bandwidth is 0.1 nm. The triplet in the neighborhood of 250 nm (enlarged on the right) can be clearly observed. This instrument allows high-resolution spectra to be measured with little noise.

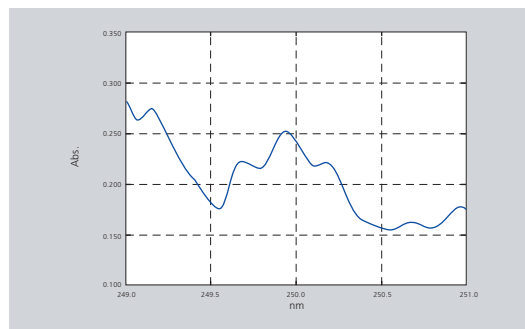
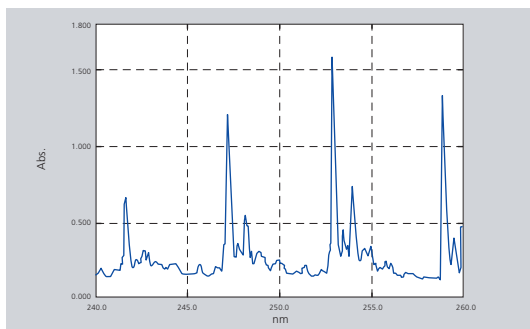

Ultra-Low Stray-Light Level of 0.00005 % Max. (340 nm)

The figure below on the left is a spectrum for aqueous NaNO₂ solution, and the figure on the right shows an enlarged view of the neighborhood of 340 nm. In the figure on the right, the red spectrum is for aqueous NaNO₂ solution and the blue spectrum is the 0 % line obtained when a shutter block is inserted on the sample-beam side. The UV-3600 Plus achieves an ultra-low stray-light level of less than 0.00005 % at 340 nm. (A mesh filter is used on the reference-beam side to maintain balance with the sample-beam side.)

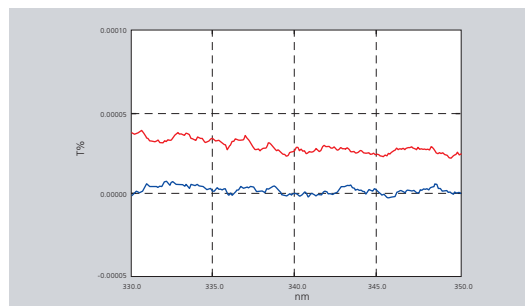
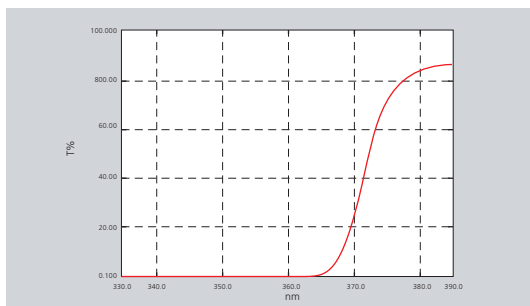

Linearity up to Absorbance Level 6

The figure on the left shows spectra obtained by measuring aqueous KMnO₄ solution at six concentration levels. A mesh filter was inserted on the reference-beam side and a differential method was used to perform measurement up to absorbance level 6. Using negative absorbance enables measurement with little noise, even at high absorbance levels. The figure on the right shows the calibration curve using peak absorbances in vicinity of 525nm for aqueous KMnO₄ solution, and shows that linearity is maintained up to absorbance level 6.

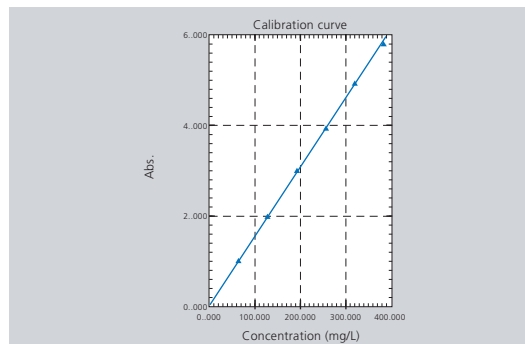
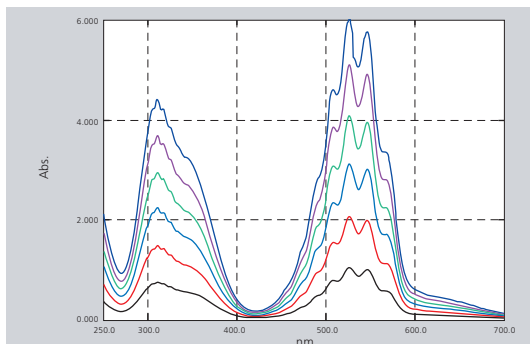

Covers Wide Wavelength Range from Ultraviolet to Near-Infrared

The wavelength range of 185 to 3,300 nm enables measurement over the ultraviolet, visible, and near-infrared regions. In addition, the acquired spectra exhibit little noise across the entire range.

The figure on the right shows a spectrum obtained by measuring toluene in the range of 185 to 3,300 nm using a cell with an optical-path length of 2 mm. Spectra in the ultraviolet, visible, and near-infrared regions can be obtained.

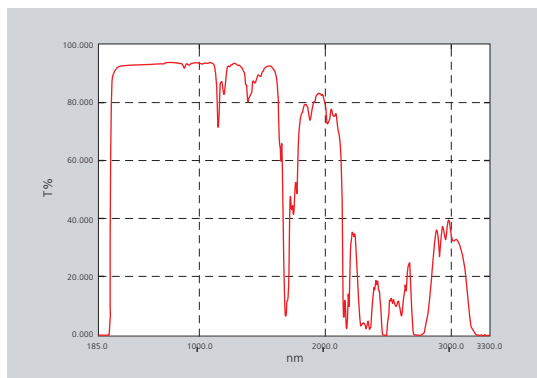

The figure on the right shows the spectrum for a low-transmittance film on a silica wafer in the range of 200 to 1,600 nm. Although the film is a special type of film with a transmittance of almost zero, it has been measured with high precision and little noise. (A mesh filter is used on the reference-beam side to maintain balance with the sample-beam side.)

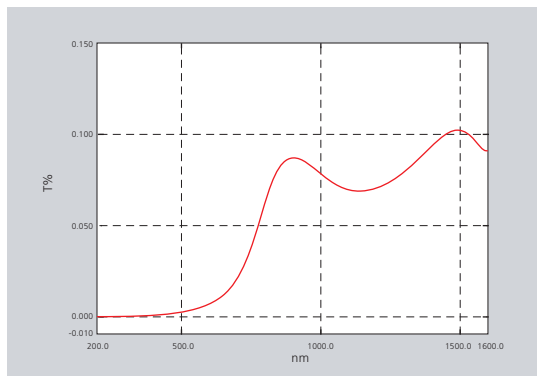

Molecules of alcohol such as 1-butanol are thought to consist of a mixture of non-hydrogen-bonded isolates and aggregates formed through relatively weak hydrogen-bonding between OH groups. As the temperature rises, the hydrogen-bonding becomes weaker and the aggregates separate into isolates.

The figure on the right shows near-infrared spectra for 1-butanol obtained at 20 °C, 40 °C, and 60 °C. The peaks in the neighborhood of 1,400 nm that become larger as the temperature increases are OH peaks for a non-hydrogen-bonded isolate. The peaks in the neighborhood of 1,600 nm that become smaller as the temperature increases are OH peaks for a hydrogen-bonded aggregate.

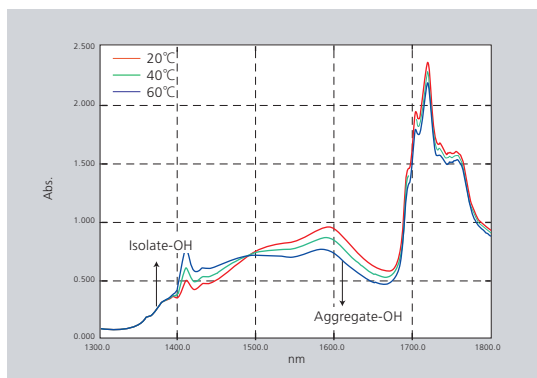

As with the main UV-3600 Plus unit, the multi-purpose large-sample compartment and integrating sphere attachment are also equipped with three detectors.

The figure on the right shows the near-infrared spectrum of a Si wafer that was measured with an ISR-603 integrating sphere attachment (InGaAs detector + cooled PbS detector). Even solid samples can be measured with low noise and high sensitivity, compared to measurements performed using only a conventional PbS detector.

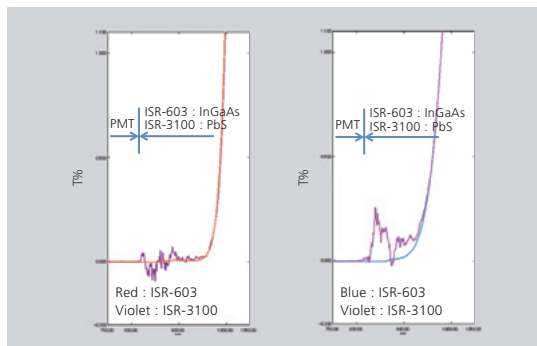

A Wealth of Applications

Electrical, Electronics, and Optics

- High-absorbance measurement of polarizing films
- Reflection measurement of multilayer films
- Absolute reflectance measurement of highly reflective mirrors
- Spectral characteristic measurement of beam splitters
- Relative emission measurement of LEDs
- Transmittance measurement of quartz plates
- Absolute reflectance measurement of anti-reflection coatings
- Transmittance measurement of functional films
- Diffuse reflectance measurement and band gap measurement of semiconductor materials
- Transmittance measurement of solar cell cover glass, etc.

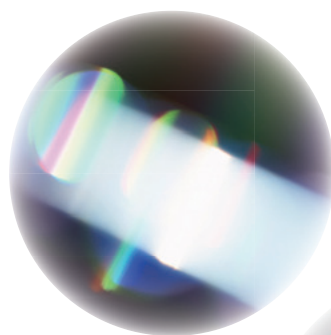

Food

- Diffuse reflectance measurement of wheat flour
- Quantitation of vitamins, food additives, and minerals
- Quantitation of phenol elution in containers and packaging materials

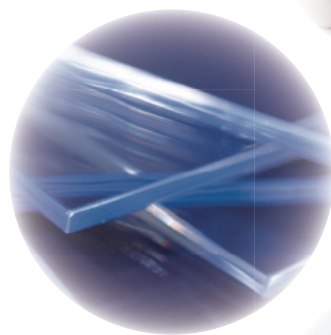

Construction

- Transmittance measurement of window glass and window glass films
- Reflectance measurement of paints and building materials



Chemicals

- Transmittance and color measurements of plastic materials
- Reflectance measurement of silica-based white powdered materials
- Thickness measurement of thin films
- Near-infrared measurement of organic solvents
- Haze measurement of Plastics

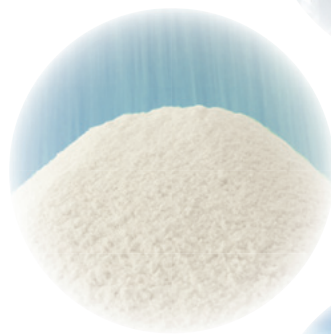

Pharmaceuticals, Cosmetics, and Life Sciences

- Cosmetic color measurement and ultraviolet screening measurement
- Measurement of drugs containing crystallization water
- Measurement of moisture in plants
- Measurement of various amino acids
- Quantitation of proteins and nucleic acids
- Near-infrared measurement of pharmaceutical components



Textiles

- Transmittance and reflectance measurements and ultraviolet screening measurement of textiles
- Color measurement of textiles



Electrical, Electronics, and Optics

Transmittance Measurement of Lenses

Imaging devices, such as mobile phones, digital cameras, and security cameras, are all equipped with lenses. The transmittance of a lens is one factor that determines lens performance. However, because the lens itself focuses light, it is an especially difficult type of sample to measure accurately.

Because of the focal capability of lenses, the total light passing through the spectrophotometer during the measurement of the baseline can be different than that after passing through the lens during measurement due to refraction. In such cases, the use of an integrating sphere can be used to collect all the light passing through the lens and provide for more accurate measurements. In addition, using the transmission-type integrating sphere included with the BIS-603 can reduce measurement errors.

Furthermore, using the V stage, provided as standard on the MPC-603 multi-purpose large-sample compartment, allows measuring the transmittance of lenses of various lengths and sizes.

The MPC-603 and BIS-603 are an ideal combination for measuring lenses.

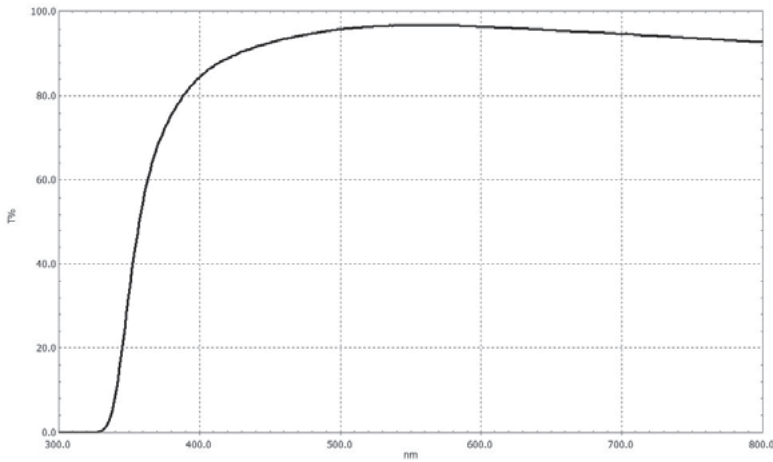

Measurement of lens by 4-hole type of integrating sphere

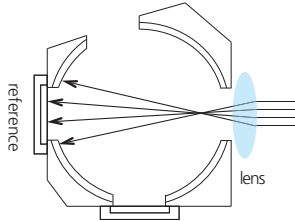

There may be measurement error caused by reflectance differences between the reference and internal surface of integrating sphere.

Measurement of lens by transmission-type integrating sphere

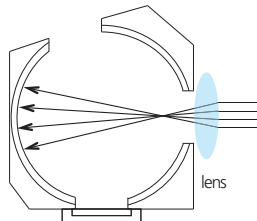

There may no measurement error because of same reflectance in internal surface of integrating sphere.

Options Used for Measurements

MPC-603 Multi-Purpose Large-Sample Compartment



BIS-603 Sample Base Plate Integrating Sphere Set

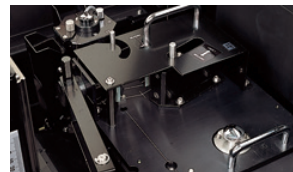

A Wealth of Applications



Electrical, Electronics, and Optics

Transmittance Measurement of Very Small Samples

The current miniaturization of various products, such as sensors, means that the measurement of very small samples is now required. The figure shows the results of a transmission spectrum measurement on a micro-sensor window.

When small samples are measured, the size of the light beam must be adjusted to the size of the sample. By using an optional MPC-603 unit and an aperture unit (P/N 206-27362-91), the measurement beam can be narrowed to 2 mm in diameter, which allows an appropriate optical system to be set up, even for measurements of extremely small areas.

The MPC-603 is a UV-3600 Plus option that enables the measurement of various samples ranging from small to large.

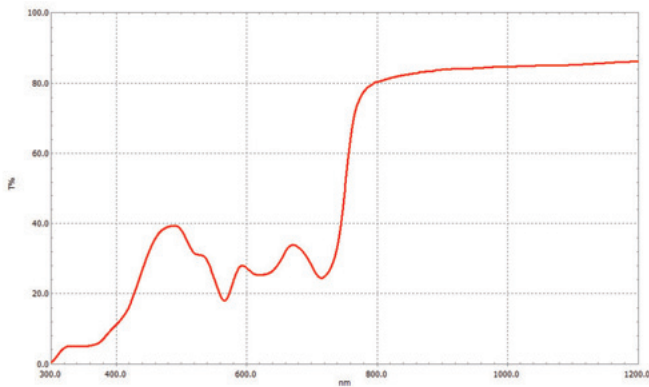

Electrical, Electronics, and Optics

Transmittance measurement of Rolled plate glass for Solar cell

Rolled plate glass is a plate glass with rough surface. When it is scanned by Small ID Integrating sphere, large steps at detector switching wave length may be occurred, and correct results may not be obtained. When it run by ISR 1503 with ID 150mm, and the sample was turned with 0, 45 and 90 degree, obtained spectra were almost same. And those spectra had very small steps at detector switching wave length.

ISR-1503/1503F are suitable for diffusion samples.

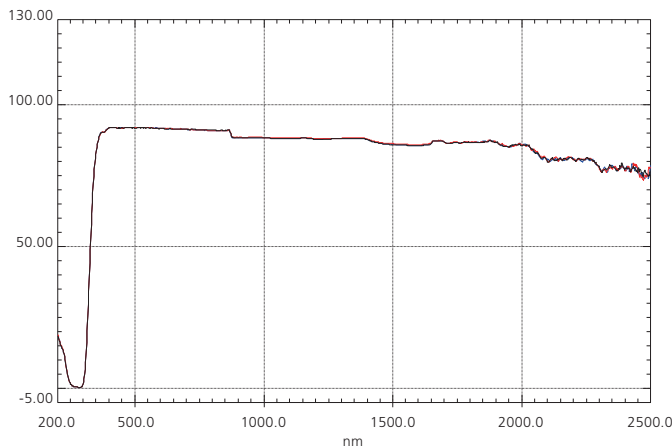

150mm Large Integrating Sphere ISR-1503



Electrical, Electronics, and Optics

Absolute Reflectance Measurement of Mirrors

The reflectance of mirrors used in telescopes, lasers, and some other devices is extremely important because it serves as a factor in determining their performance. The total light reflecting off of a sample can be composed of a specular component and a diffuse component. For mirrors, the specular reflectance is the reflectance component of significance. In addition, reflectance measurements can be made as relative to the reflectance of a background material or as absolute. Absolute values of specular reflectance are determined by use of an absolute reflectance measurement (ASR) accessory. The figure below shows the results of measuring a mirror.

An absolute reflectance attachment, which enables measuring the reflectance of mirrors, can be installed on the optional MPC-603 unit.

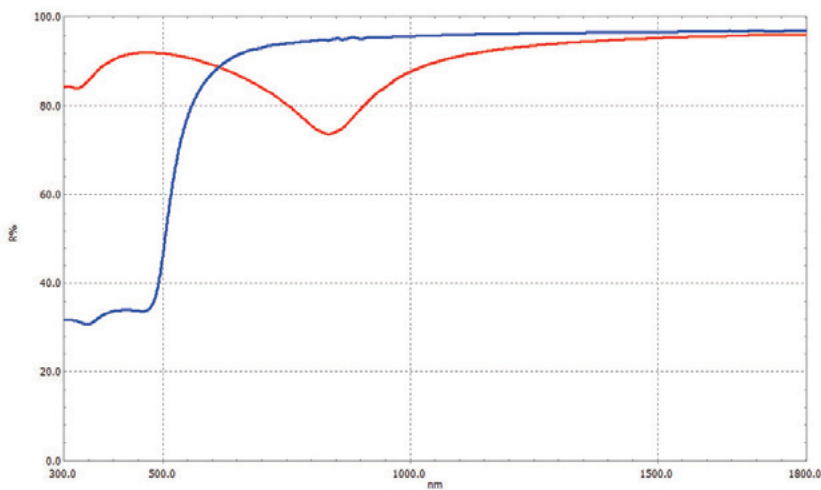

Options Used for Measurements

MPC-603 Multi-Purpose Large-Sample Compartment



ASR-3105/3112/3130/3145 Absolute Reflectance Attachment

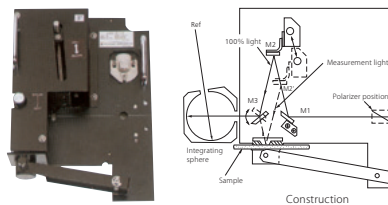

BIS-603 Sample Base Plate Integrating Sphere Set

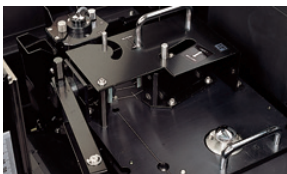

Large Polarizer Set, Polarizer Type I, Type II, Type III



A Wealth of Applications



Electrical, Electronics, and Optics

Band Gap Calculation

Research into solar-cell and photocatalytic materials often involves the measurement of the band gap, which is a basic physical property of the materials. Shown below are the diffuse reflectance spectra of three semiconductor materials used in the production of solar cells using the ISR-603 integrating sphere. The absorption edge, the wavelength where the reflectance decreases, differs depending upon the sample type. This difference indicates a difference in the band gap* of the samples.

The band gaps of the samples were calculated using the Tauc method, and were determined to be 1.63eV for CuGaSe₂ (red line) 1.27 eV for CuIn_{0.5}Ga_{0.5}Se₂ (blue line) and 0.99 eV for CuInSe₂ (black line).

* The band gap refers to the energy difference between the top of the valence band filled with electrons and the bottom of the conduction band devoid of electrons. The wavelength range of the UV-3600 Plus is extremely effective for band gap calculations.

* The samples are courtesy of the Wada Laboratory, Faculty Science and Technology, Ryukoku University.

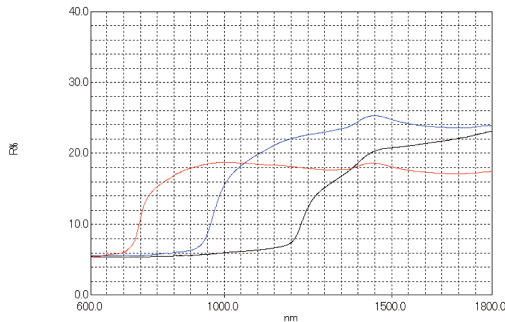

Sample	Band Gap Value
CuGaSe ₂	1.63 eV (757nm)
CuIn _{0.5} Ga _{0.5} Se ₂	1.27eV (977nm)
CuInSe ₂	0.99eV (1253nm)

Options Used for Measurements

Excel Macro for Band Gap Calculation

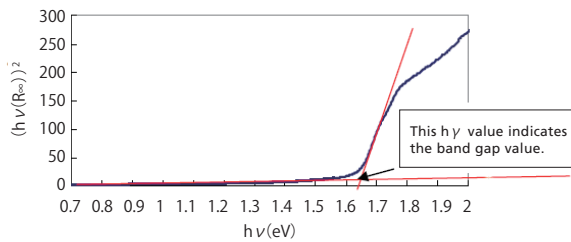

ISR-603 Integrating Sphere Attachment





Chemicals

Thickness Measurement of Plastic Wrap for Food Packaging

Interference wave patterns sometimes occur when light passes through a thin, transparent film. The film thickness of a sample can be determined from the wavelength intervals of these interference wave patterns. The figure shows the transmittance spectrum of plastic wrap for food packaging. An interference wave pattern can be seen. By utilizing the optional film thickness measurement software, the film thickness was calculated to be 10.4 μm.

Note: The refractive index of the sample must be entered in order to perform the calculation.

The number of interference fringes decrease as the film gets thinner. The wide wavelength range of the UV-3600Plus allows for the measurement of interference fringes for very thin films.

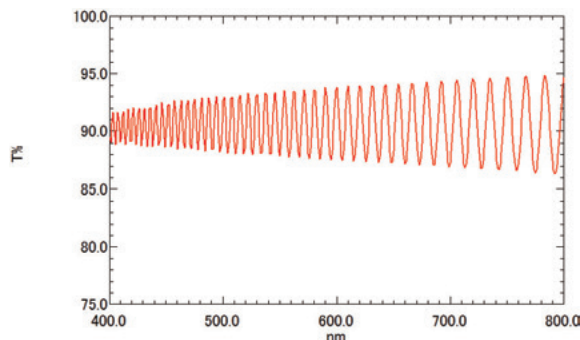

Options Used for Measurements

Film Thickness Measurement Software

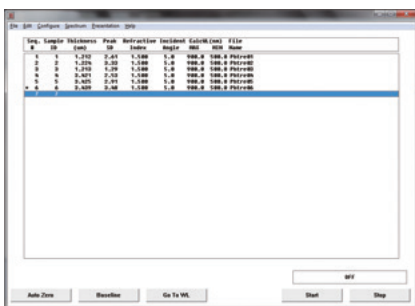

Film Holder



ISR-1503



Chemicals

Haze measurement of Plastics

Because plastics are widely used now, clear plastic materials are required such as lens. Haze value is a one kind of evaluation of transmittance for plastics. Haze value is calculated by ratio of total transmittance and diffuse reflectance. Smaller Haze value is more clear material. ø150mm ISR-1503 can mount transmittance sample as horizontal. Here is a Haze measurement result of misty plastic plate. Spectra were ones of total transmittance and diffuse reflectance. Haze value was 32.9.

ISR-1503/1503F is suitable for Haze measurement.

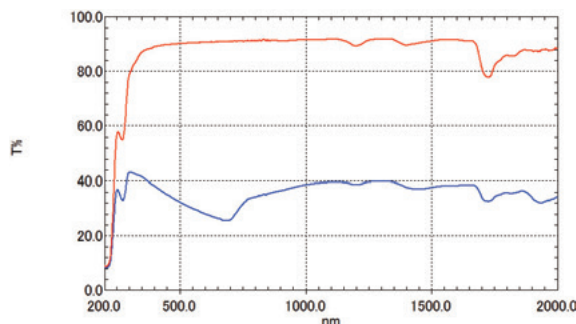

Haze Value (%) = 32.9

Calculated by Total transmittance and
Diffuse reflectance at 550nm.

Note
Obtained Haze Value may be different Dedicated Haze meters.

A Wealth of Applications



Construction

Transmission Measurement of Window Glass (Solar Transmittance)

In recent years, measures to offset the effects of Global Warming and Heat Islands have included the incorporation of various kinds of functional glass into modern building materials. These new glass materials reduce the transmittance of infrared radiation and also offer thermal insulation potential. Solar transmittance is defined by JIS as an index that represents the transmission characteristics of sunlight, from visible to near-infrared light. The figure below shows the results of measuring the transmission spectra of various types of glass and calculating their solar reflectance. It reveals that solar transmittance varies depending on the type of glass.

This method of measuring solar transmittance requires a 250 to 2100 nm measurement range and an integrating sphere. The combination of the UV-3600 Plus and ISR-603 is ideal for solar transmittance measurements.

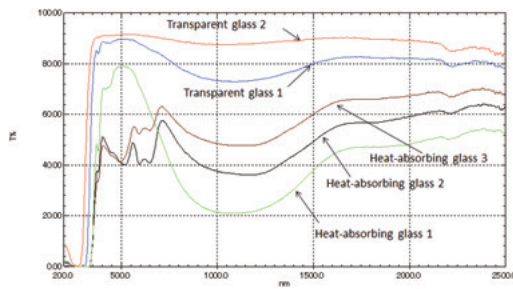

Data Name	Solar Transmittance (Te)	Visible Light Transmittance (TV)
Transparent glass 1	81.412	88.733
Transparent glass 2	89.612	91.339
Heat-absorbing glass 1	47.428	75.051
Heat-absorbing glass 2	44.367	43.323
Heat-absorbing glass 3	52.023	50.029

Options Used for Measurements

ISR-603 Integrating Sphere Attachment



DTL-UVPC Solar Transmittance Measurement Software

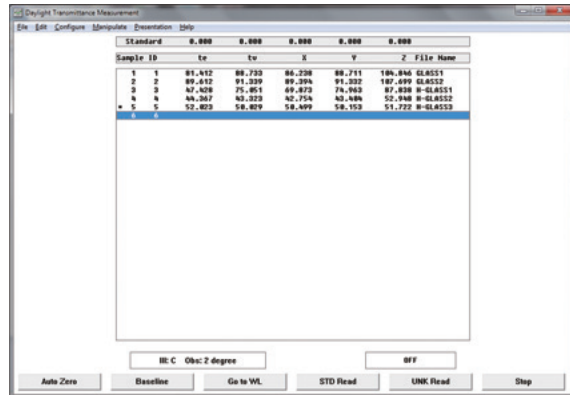



Textiles

Diffuse Reflectance Measurement of Various Fabrics

The diffuse reflectance spectra of various textiles were measured in the visible region using the ISR-603 integrating sphere attachment. The blue line indicates a blue fabric and the red line indicates a red fabric. The blue fabric mainly reflects short-wavelength blue light, so it appears blue, while the red fabric mainly reflects long-wavelength red light, so it appears red. The combination of the UV-3600 Plus and the ISR-603 is ideal for measuring color. Also, the optional color measurement software enables colors to be calculated and displayed in a variety of color space models.

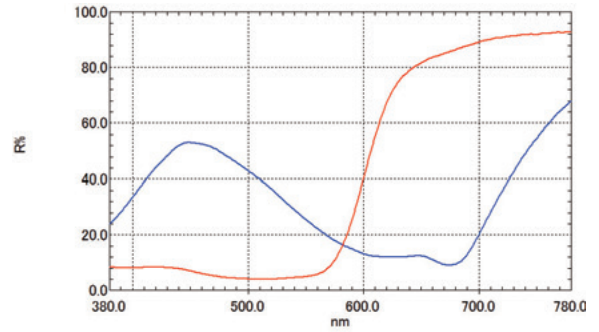

Options Used for Measurements

Color Measurement Software

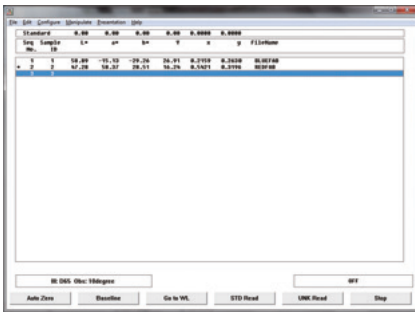

ø60mm ISR-603 Integrating Sphere Attachment



Pharmaceuticals

Measurement of Anhydrous Caffeine in Cold Remedy

Anhydrous caffeine is included in cold medicines. The figure below shows the results of measuring anhydrous caffeine using a powdered sample holder. It enables volumes as small as 0.16 mL to be measured easily.

The combination of the UV-3600 Plus, ISR-603, and powdered sample holder is ideal for the diffuse reflectance measurement of powder.

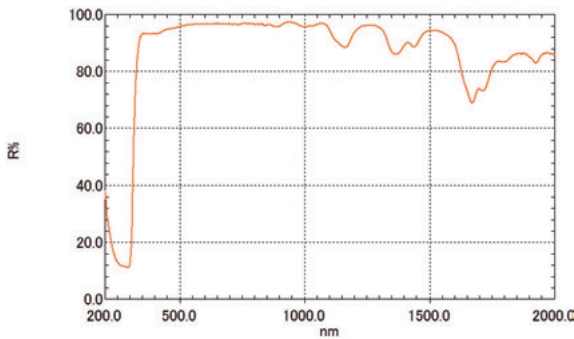

Options Used for Measurements

Powdered Sample Holder

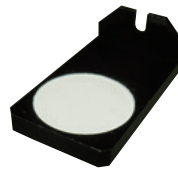

ISR-603 Integrating Sphere Attachment



Foods

Quantitation of Amount of Fat in Foods

Recently, fat-modified products become widely available. Gerber method and Roesse-Gottlieb method are usually used to determine the fat level in milk, while it requires a long measurement time. Therefore, the measurement was conducted using a combination of spectral reflectance method and multivariate analysis. The figure below shows the spectral reflectance spectrum of milk sample, which was placed in a screw tube, measured by UV-3600 Plus and ISR-603. The quantitation of amount of fat was conducted by generating a calibration curve using the spectrum and fat amount data.

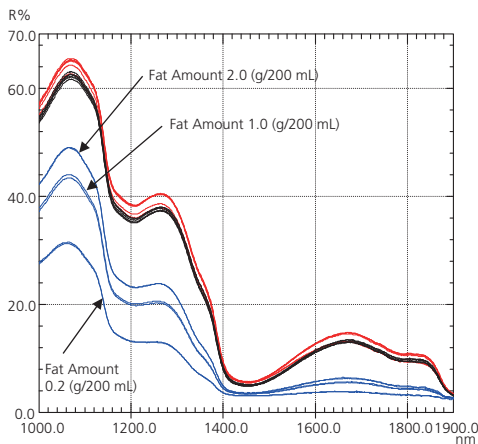

Samples	Amount of Fat Shown on the Milk Carton Package (g/200mL)	Estimation Results Using Multiple Regression Analysis Methods	Estimation Results Using PLS Regression Methods	Estimation Results Using Support Vector Regression Analysis Methods
Creamy 3 (1 st time)	9.5	8.87 (6.6%)	9.57 (0.7%)	9.72 (2.3%)
Creamy 3 (2 nd time)	9.5	8.89 (6.4%)	9.67 (1.6%)	9.47 (0.3%)
Regular 3 (1 st time)	7.6	8.04 (5.8%)	8.40 (10.5%)	7.88 (3.7%)
Regular 3 (2 nd time)	7.6	7.59 (0.1%)	7.71 (1.4%)	7.31 (3.8%)
Low Fat 3 (1 st time)	2.0	2.24 (12.0%)	1.78 (11.0%)	2.01 (0.5%)
Low Fat 3 (2 nd time)	2.0	2.36 (18.0%)	1.72 (14.0%)	1.86 (7.0%)

Accessories

ISR-603 Integrating Sphere Attachment

(P/N 207-20100-58)

This attachment is used for the measurement of diffuse and specular reflectance. Transmission of liquid and solid samples can also be measured.

- Wavelength range : 220 to 2600 nm
- Integrating sphere : 60 mm I.D.
BaSO₄
- Detectors : PMT, InGaAs, cooled PbS
- Maximum size of reflective sample : Approx. 100 mm dia. × 15 mm thick
- Incident angle : 0 deg. / 8 deg.
- Aperture ratio : 9.8 % for 0 deg. reflectance

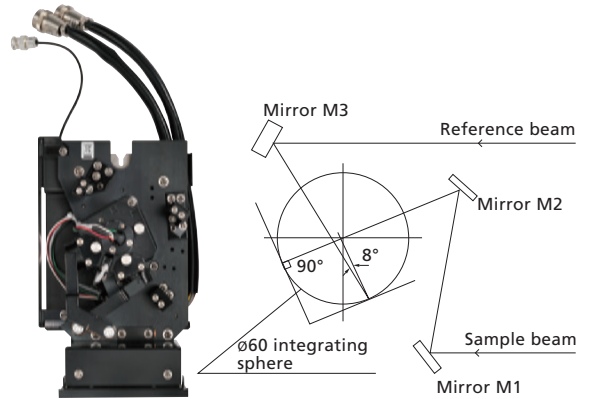

ø150mm Large Integrating Sphere

ISR-1503 (BaSO₄) (P/N 207-20900-51)

ISR-1503F (Spectraron) (P/N 207-20900-51)

This attachment is used for measuring reflection spectra of solid samples, such as powders, papers, and cloth. This is also used for transmission measurement of solution and solid samples, featuring high stability, excluding the influence of the state of the sample surface. Application with low aperture ratio required ISR-1503F with Spectraron gives high sensitive measurement on NIR region without absorption of water.

- Measurement wavelength range : 200~2500 nm
- Internal diameter : ø150 mm
- Material : Spectraron, BaSO₄
- Detector : PMT/PbS/InGaAs
- Incident angle : 0 and 8 degree
- Aperture ratio : 3.0 % for 0 deg. reflectance



Specular Reflectance Measurement Attachment (5° Incident Angle)

(P/N 206-14046)

The technique of specular reflectance measurement is often applied to the examination of semiconductors, optical materials, multiple coating/film layers, etc, and are relative to a reference reflecting surface. The 5° incident angle minimizes the influence of polarized light so no polarizer is required, providing for a simple operation.

- Samples as large as W100 × D160 × T15 mm can be readily measured. The minimum size is 7 mm in diameter.
- Sample placement is easy - just set it on a holder with the measuring surface down.

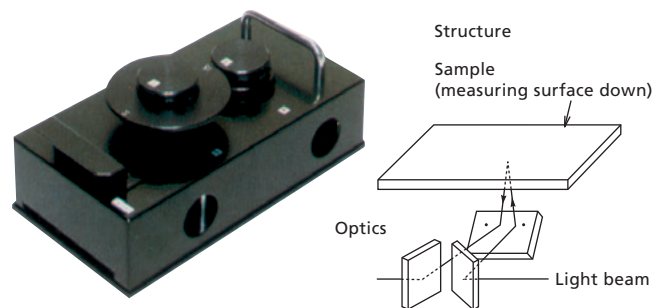

Powdered Sample Holder

(P/N 206-89065-41)

This powdered sample holder simplifies the reflectance measurement of powder samples using an integrating sphere. The container is ideal for powders that do not pack well into conventional powder holders. It can be attached to all Shimadzu integrating spheres.

- Capacity of 0.16 mL, 3 included



Accessories

MPC-603 Multi-Purpose Large-Sample Compartment

(P/N 207-20600-58)

This multi-purpose sample compartment allows measurement of various shaped samples to obtain both reflection and transmission spectra. An integrating sphere is built-in to ensure accurate measurement of solid samples.

- Wavelength range : 240 to 2600 nm
- Detectors : PMT, InGaAs, cooled PbS
- Maximum sample size : Transmission 305 mm dia. × 50 mm thick
or 204 mm dia. × 300 mm thick
Reflection 305 mm dia. × 50 mm thick
- Original S-beam/R-beam switching function allows reflection measurement using incidence angles of 0 deg. for diffuse reflectance measurements and 8 deg. without leaning the sample for total reflectance measurements.
- The V stage is built-in. The sample position can be freely adjusted both forward and backward as well as up and down.



Note 1: A separate space must be provided for the personal computer.

Note 2: A small table for the MPC-603 must be provided separate from that for the UV-3600 Plus. Table dimensions: Able to accommodate MPC-603 unit (W580 × D420 mm)
Table height: Within +8 to -15 mm of the UV-3600 Plus table height

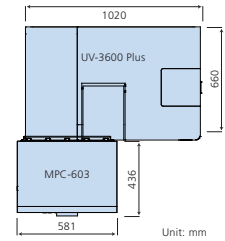

Absolute Reflectance Attachment

Model	P/N
ASR-3105 Absolute Reflectance Attachment, 5°	206-16817
ASR-3112 Absolute Reflectance Attachment, 12°	206-16100
ASR-3130 Absolute Reflectance Attachment, 30°	206-15001
ASR-3145 Absolute Reflectance Attachment, 45°	206-15002

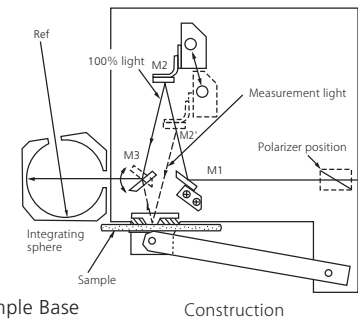
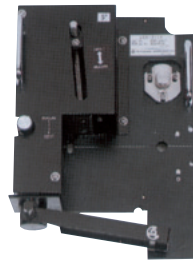

These accessories are intended for use with the MPC-603 Sample Compartment and require the BIS-603 Sample Base Plate-Integrating Sphere Set (P/N 206-17059). At larger angles of incidence (30°, 45°), a polarizer is also required.

- Wavelength range : 300 to 800 nm
- Accuracy : with respect to 90 % reflectance samples
- Incidence angle 5° : ±1.5 %
- Incidence angle 12° : ±1.0 %
- Incidence angle 30°, 45° : ±2.5 %
- 100 % level sample setting : The sample measurement optical path can be switched using the single-touch V-N method.
- Approximate sample size : 25 to 200 mm dia., or 20 to 150 mm square, up to 30 mm thick

Note: The BIS-603 Sample Base Plate-Integrating Sphere Set (P/N 207-21100-58) is required for mounting these absolute specular reflectance attachments.

BIS-603 Sample Base Plate Integrating Sphere Set

(P/N 207-21100-58)

This base plate is used to install an absolute specular reflectance attachment in the MPC-603 multi-purpose chamber.

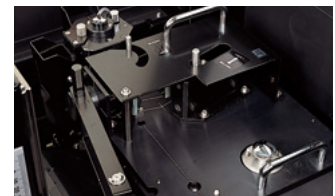

ASR-3112 attached on the BIS-603

Large Polarizer Set, Polarizer Type I, Type II, Type III, Polarizer Adaptor Set

Polarizers are needed to obtain highly precise absolute reflectance measurements at large incident angles without affecting the polarization characteristics.

The Polarizer Adaptor set (P/N 206-15693) is required for the Polarizer Type I, Type II and Type III.

Model	P/N	Effective Diameter	Wavelength Ranges
Large Polarizer Set	206-15694	20 mm	250 to 2500 nm
Polarizer Type I	206-13236-01	18 mm	400 to 800 nm
Polarizer Type II	206-13236-02	17 mm	260 to 700 nm
Polarizer Type III	206-13163	10 mm	260 to 2500 nm



Film Holder

(P/N 204-58909)

Used in transmittance measurement of thin samples such as films and filters.



- Sample Size
Minimum : W16 × H32 mm
Maximum : W80 × H40 × t20 mm

Rotating Film Holder

(P/N 206-28500-41)

This film holder can rotate samples in a plane centered on the optical axis. Polarizers Type I, II, and III can be attached to the base plate. The Large Polarizer Set cannot be used.

- Sample size : 33 mm × 30 mm × 2 mm thick

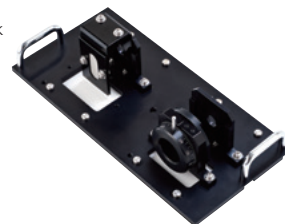

Four-Cell Sample Compartment Unit

(P/N 206-23670-91)

Accommodates 4-cell holders of various types.

- Incorporates a 4-cell holder for 10-mm standard cells.



Multi-Cell Sample Compartment

(P/N 206-69160-01)

Holds up to six 10-mm square cells on the sample side. No temperature control capability.

- Number of cells : 6 on the sample side
1 on the reference side

Note: Cells are not included.

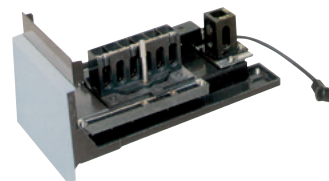

Universal Rectangular Cell Holder, Four-Cell Type

(P/N 204-27208)

Holds four rectangular cells with an optical path length of 10, 20, 30, 50, 70, or 100 mm.

Note:

The Four-Cell Sample Compartment unit (P/N 206-23670-91) is required. When a rectangular, long-path cell is used on the reference side, its holder (P/N 204-28720) is required.

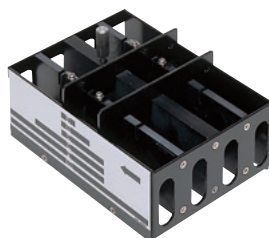

Reference-Side Rectangular Long-Path Absorption Cell Holder

(P/N 204-28720)

If using a 4-cell-type universal rectangular cell holder, only use a reference-side cell holder if necessary.



Long-Path Rectangular Cell Holder

(P/N 204-23118-01)

Holds two rectangular cells with an optical path length of 10, 20, 30, 50, 70, or 100 mm.



Cylindrical Cell Holder

(P/N 204-06216-02)

Holds two cylindrical cells with an optical path length of 10, 20, 50, or 100 mm.



Accessories

Super Micro Cell Holder

(P/N 206-14334)

Holds supermicro cells for measurement of extremely small volume samples. The cell height is adjustable, and the required sample volume can be adjusted in the range of 50 to 200 μL , depending on the type of black cell used.

- Applicable cells : ⑦, ⑧, and ⑨ in the list of cells on page 12. Cells are not included.
- Mask : Choice of W1.5 x H1 mm or W1.5 x H3 mm

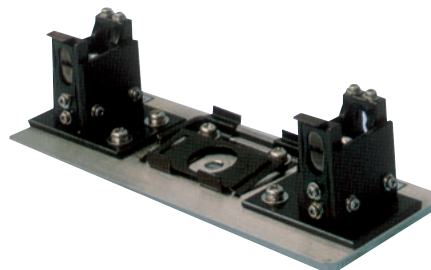

Micro Cell Holder with Mask

(P/N 204-06896)

Required when using semi-micro cells or micro cells with an optical path width of 3 mm or less. (The mask width can be adjusted.)

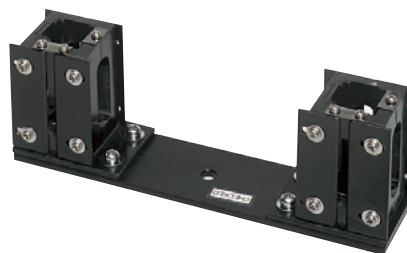

3- μL Capillary Cell Set for Ultramicro Volume Measurement

(P/N 206-69746)

Recommended for small-volume and precious samples, such as in biological applications. Solution sample is drawn into the capillary cell by capillary action. The end of the capillary cell is sealed with the critoseal and the capillary cell is set in the capillary cell adapter, where it is analyzed. The holder is the same size as a 10-mm standard cell and can be mounted to the standard cell holder.

- The minimum sample volume required : 3 μL when tube closure is used (theoretical value)
- Supplied with 100 capillaries (made of quartz) and a tube closure
- Inner diameter of capillary : 0.5 mm

Note: Usually, the effective optical path length is approximately one-twentieth of a 10-mm square cell.

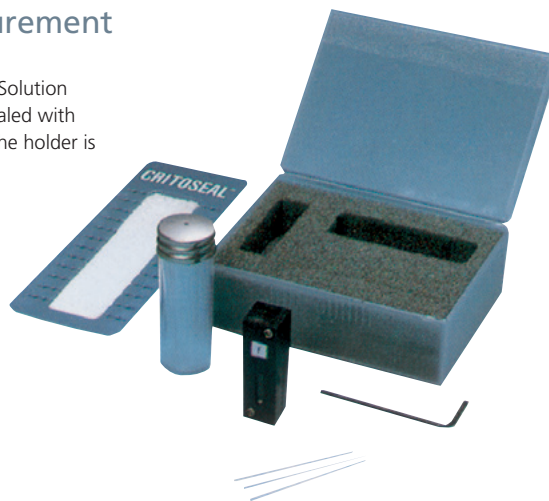

Mesh fileter ASSY

(P/N 206-82299-91)

This is an accessory to insert a couple of Mesh filter into the Cuvet holder. It is inserted into reference cuvet holder when high absorption sample is measured.



8/16-Series Micro Multi-Cell

Cell Holders

Model	P/N
8/16 Series Micro Multi-cell Holder MMC-1600	206-23680-91
8/16 Series Constant-Temperature Micro Multi-cell Holder MMC-1600C	206-23690-91

This cell holder holds one 8 or 16-cell micro multi-cell for micro-volume measurement. Two types of micro multi-cell holders are available: the standard type (MMC-1600) and the constant-temperature water circulation type (MMC-1600C).

- Applicable temperature range : 10 °C to 60 °C (C type)
- Temperature deviation between circular water and cell : max. 3 °C (C type)
- Temperature stabilizing time : 15 min or less (C type)

Micro Multi-Cells

Model	P/N
8-series Micro Multi-cell; optical path length; 10 mm; cell volume: 100 µL	208-92089
16-series Micro Multi-cell; optical path length: 10 mm; cell volume: 100 µL	208-92088
8-series Micro Multi-cell; optical path length: 5 mm; cell volume: 50 µL	208-92086
16-series Micro Multi-cell; optical path length: 5 mm; cell volume: 50 µL	208-92085

There are two types of micro multi-cells available in both the 8-series and 16-series models: a 50 µL type and a 100 µL type. The cell intervals of the 8-series micro multi-cells are applicable for use with 8 × 12-well microplates and 8-channel pipettes. Microplate samples aspirated into multi-channel pipettes can be injected directly into the cells for measurement.

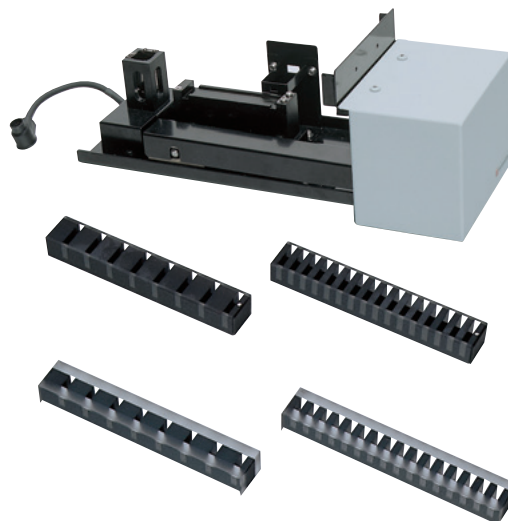

- Micro-volume samples can be measured. (Minimum sample volume : 50 µL to 100 µL)
- Support for commercial microplates and micro pipettes (with 8-series micro cells).
- Up to 16 samples can be measured at a time (with 16-series micro cell).

CPS-100 Cell Positioner, Thermoelectrically Temperature Controlled

(P/N 206-29500-41)

This attachment permits measurement of up to six sample cells under constant-temperature conditions. Combination of this attachment and the Kinetics mode of UVProbe software provides measurement of temperature-sensitive enzyme kinetics of one to six samples.

- Number of cells : 6 on the sample side (temperature-controlled)
1 on the reference side (temperature not controlled)
- Temperature control range : 16 °C to 60 °C
- Temperature display accuracy (difference from the true value) : ±0.5 °C
- Temperature control precision (variation of temperature) : ±0.1 °C
- Ambient temperature : 15 °C to 35 °C

Note: Standard cells (P/N 200-34442) is not included, please purchase separately.
A USB adapter CPS (P/N 206-25234-91) is required.



TCC-100 Thermoelectrically Temperature Controlled Cell Holder

(P/N 206-29510-41)

Uses the Peltier effect for controlling the sample and reference that meets the following specifications :
no thermostated bath or cooling water is required.

- Number of cells : One each on the sample and reference sides (temperature-controlled)
- Temperature control range : 7 °C to 60 °C
- Temperature display accuracy (difference from the true value) : ±0.5 °C
- Temperature control precision (variation of temperature) : ±0.1 °C

Note: Standard cells (P/N 200-34442) is not included, please purchase separately.



Accessories

Constant-Temperature Cell Holder

(P/N 202-30858-04)

Maintains a sample cell and reference cell at a desired, uniform temperature by circulating constant-temperature water.

- Temperature range : 5 °C to 90 °C
(depends on the performance of the constant-temperature water circulator)
- Cell holder : Accepts a pair of 10-mm standard cells.
- Connecting joint outer diameter : 6 mm and 9 mm (two levels)

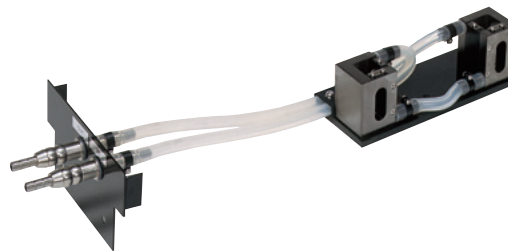

Constant-Temperature Four-Cell Holder

(P/N 204-27206-02)

Maintains four sample cells and a reference cell at a desired, uniform temperature by circulating constant-temperature water.

- Temperature range : 5 °C to 90 °C
(depends on the performance of the constant-temperature water circulator)
- Cell holder : Accepts four 10-mm standard cells plus a reference cell
- Connecting joint outer diameter : 9 mm



Note: The Four-Cell Sample Compartment Unit (P/N 206-23670-91) is necessary.

S-1700 Thermoelectric Single-Cell Holder

(P/N 206-23900-91)

This cell holder permits setting of a temperature program to increase and decrease the sample cell temperature.

- The thermoelectric system allows prompt control of sample temperature between 0 °C and 110 °C.
- Temperature increase/decrease speed can be changed using 12 settings, which means the holder can be used in analysis of melting curves for nucleic acids, etc. that occur during quick as well as slow heating (or cooling).
- A stirrer is also provided to ensure uniform temperature distribution throughout the cell.
- Cooling water circulation is required for Peltier element cooling. And though tap water can be used, it is recommended that a commercially available constant-temperature water circulator be used, as the following conditions must be fulfilled to exact maximum performance from the S-1700.
 - Cells are not supplied. Please use 10-mm standard tight-sealing cells (a Hellma product).
 - Temperature accuracy in cell (when room temperature is 25 °C) :
 - Within 0.25 °C (0 °C to 25 °C)
 - Within $\pm 1\%$ of set value (25 °C to 75 °C)
 - Within $\pm 2\%$ of set value (75 °C to 110 °C)
- Cooling water specification : 20 ± 2 °C Water flow : 4.8 L/min or more.
- Temperature is not controlled at the reference side.



Type	Minimum Sample Volume Required	Optical Path Length
110-QS-10	10 mm	3.5 mL
115B-QS-10	10 mm	400 μ L

TMSPC-8 Tm Analysis System

(P/N 206-24350-91)

This system obtains a temperature-versus-absorbance curve data, and the Tm Analysis Software analyzes the Tm (melting temperature) of nucleic acids such as DNA and RNA. The system consists of an 8 Series Micro Multi-Cell Holder, Tm Analysis Software, and Temperature Controller. 8 Series Micro Cells, Silicone Cap, and Constant-Temperature Water Circulator for protecting the Peltier device are not included. Please purchase separately.

Model	P/N
8 Series Micro Cell Optical Path 10 mm, Sample Volume 100 μ L	208-92097-11
8 Series Micro Cell Optical Path 1 mm, Sample Volume 35 μ L	208-92140
Silicone Cap for Micro Cell (24 pcs)	206-57299-91

- Temperature control range : 0.0 to 10.0 °C
- Tm Calculation mode : Average Method, Differential Method
- OS : This software runs on Windows 10 Professional (64-bit version) or Windows 7 Professional (64/32-bit version).



Note: Please purchase a constant-water circulator that meets the following specifications :
 Temperature range : 20 ± 2 °C, Flow rate: 4.8 L/min or more
 Inner diameter of the connecting pipe : 8, 10, 12 mm dia.

NTT-2200P Constant-Temperature Water Circulator

(P/N 208-97263)

Circulates temperature-controlled water to a constant-temperature cell holder.

- Temperature range : Ambient +5 °C to 80 °C
- Temperature control precision : ± 0.05 °C or more
- Maximum pumping rate : 27/31 L/min, 9.5/13 m (50/60 Hz)
- External circulation nozzle : 10.5 mm OD (both outlet and return)
- Tank capacity : About 10 L (9 L during use)
- Safety features : Detection of over-temperature of Upper or Lower limits, Detection of heater wire malfunction, Protection from heating too little circulating water, Detection of sensor malfunction, Independent over-heat protection, Over-current circuit protector
- Standard accessories : Lid with handles, Rubber hose (4 m; inner diameter: 8 mm; outer diameter: 12 mm; quantity: 1), Hose clamps (4 pcs), instruction manual (Japanese and English)
- Dimensions : W270 × H560 × D400 mm
- Power requirements : 100 VAC, 1,250 VA, with 1.7-m power cord and grounded plug



Sipper Unit

Model	P/N	Standard Sample Volume
Sipper Unit 160L (Standard Sipper)	206-23790-91	2.0 mL
Sipper Unit 160T (Triple-Pass Sipper)	206-23790-92	1.5 mL
Sipper Unit 160C (Constant-Temperature Sipper)	206-23790-93	2.5 mL
Sipper Unit 160U (Supermicro Sipper)	206-23790-94	0.5 mL

Four types of sipper units with different flow cell types are available. The stepping motor-driven peristaltic pump ensures reliable and smooth aspiration of sample solution.

(These sippers can be controlled directly from the UV-3600 Plus so no interface is required.)

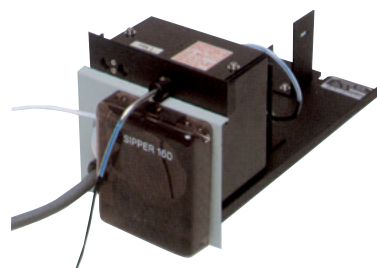

Note: The use of a Solenoid Valve (Fluoropolymer) (P/N 204-06599-01) and the SWA-2 Sample Waste Unit (P/N 206-23820-91) are recommended when measuring strong acids, strong alkalis, or organic solvents.

Syringe Sipper

Model	P/N
Syringe Sipper N (Normal temperature type)	206-23890-51
Syringe Sipper CN (Constant temperature, water circulator type)	206-23890-92

The sipper unit employs a syringe-pump system. The liquid-contact surfaces are composed of a Fluoropolymer, glass, or quartz, imparting excellent chemical resistance and ease of maintenance, and allowing measurement of almost any sample type. Further, the extremely high repeatability of the sipping volume (repeat precision: ± 0.03 mL) makes it ideal when performance validation is required.

Note: Flow cell available separately. Choose from the recommended flow cells listed below.

Recommended Flow Cells				
Cell Type	P/N	Optical Path Length	Dimensions of Aperture	Standard Required Sample Volume
Square (ultra-micro)	208-92114	10 mm	2 mm dia.	0.9 mL
Square (micro)	208-92113	10 mm	3 mm dia.	1.0 mL
Square (semi-micro)	208-92005	10 mm	11 (H) × 3.5 (W) mm	5.0 mL



- The type of flow cell can be selected in accordance with the application.
- The flow cell can be changed independently for excellent ease of maintenance. (CN type)
- Circulated-water temperature range : ambient to 60 °C

Note: If a square flow cell (micro or supermicro) is used, attaching mask R (P/N 206-88679) to the reference cell holder is recommended to balance the light intensity.

Accessories

ASC-5 Auto Sample Changer

(P/N 206-23810-91)

Combine with a Sipper 160 to build an automated multi-sample spectrophotometry system.

- The aspirating nozzle is programmed to move in the X, Y, and Z (vertical) directions.
- Up to 8 sets of operational parameters, including rack size and the numbers of test tubes, can be set. The numbers are stored in battery backed-up internal memory.
- Up to 100 test tubes may be set together on the rack.

Note 1: An ASC USB adapter (P/N 206-25235-91) is required.

Note 2: A commercially available test tube stand, with a footprint smaller than 220 × 220 mm, is applicable.



UV Automation System Connection Kit

(P/N 206-80880-01)

This kit makes it possible to connect the instrument to a Gilson GX-271 liquid handler. The liquid handler automates various pretreatment tasks, such as dispensing and diluting the sample and adding reagents.

This kit enables the spectrophotometer to operate together with the liquid handler during measurements.

- The connection kit consists of a flow cell unit and connection cable.

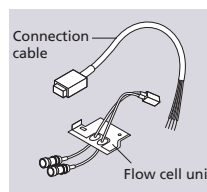

10-mm Micro Flow-thru Cell with Holder (P/N 204-06222) 5-mm Micro Flow-thru Cell with Holder (P/N 204-06222-01)

P/N	Optical Path Length	Volume
204-06222	10 mm	0.3 mL
204-06222-01	5 mm	0.15 mL

Used for the continuous analysis of samples such as the liquid output of column chromatography.

- Inner diameter of tube : 1 or 2 mm

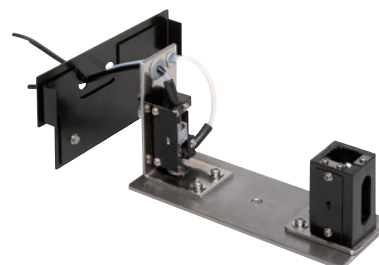

Front Panel with Holes

(P/N 204-27588-03)

Allows the tubes of a flow cell, for example, to be connected through the front panel of the instrument.



Flow-Thru Cell for HPLC

(P/N 206-12852)

With this flow-thru cell attached, the spectrophotometer can be used as a variable-wavelength UV-VIS detector for an HPLC system.

- Inner diameter : 1 mm; Optical path length : 10 mm; Inner volume : 8 μ L
- Flow-thru cell on the sample side and cell holder with a mask on the reference side.
- SUS tube : Outer diameter : 1.6 mm; Inner diameter : 0.3 mm

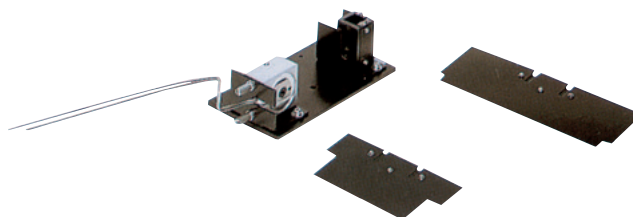

Cells

Description	Optical Path (L)	Required Sample Volume	Type	Fused Silica (S)	Glass (G)	Fused Silica (IR)
Rectangular cell	10 mm	2.5 to 4.0 mL	①	200-34442	200-34565	200-66579-01
	20 mm	5.0 to 8.0 mL	⑥	200-34446	200-34446-01	200-66579-02
	50 mm	12.5 to 20.0 mL		200-34944	200-34944-01	200-66579-03
	100 mm	25.0 to 40.0 mL		200-34676	200-34676-01	200-66579-04
Square cell with stopper	10 mm	2.5 to 4.0 mL	②	200-34444	200-34444-01	200-66579-21
Semi-micro cell	10 mm	1.0 to 1.6 mL	③ *1	200-66501	200-66501-01	200-66579-11
Semi-micro black cell	10 mm	1.0 to 1.6 mL	③' *1	200-66551	—	200-66579-12
Supermicro black cell	5 mm	25 to 100 µL	⑦' *2	208-92116	—	—
	10 mm	50 to 200 µL	⑦ *2	200-66578-11	—	—
Micro black cell	10 mm	50 to 400 µL	⑧ *2	200-66578-12	—	—
Cylindrical cell	10 mm	3.8 mL	④	200-34448 (silica window)	200-34448-01 (glass window)	200-66579-31 (silica window IR)
	20 mm	7.6 mL		200-34472 (//)	200-34472-01 (//)	200-66579-32 (//)
	50 mm	19.0 mL		200-34473-01 (//)	200-34473-03 (//)	200-66579-33 (//)
	100 mm	38.0 mL		200-34473-02 (//)	200-34473-04 (//)	200-66579-34 (//)
Short path cell	1 mm	0.3 to 0.4 mL	⑤	200-34660-01	200-34662-01	200-66579-05
	2 mm	0.5 to 0.8 mL		200-34655	200-34662-11	200-66579-06
	5 mm	1.3 to 2.0 mL		200-34449	200-34449-01	200-66579-07

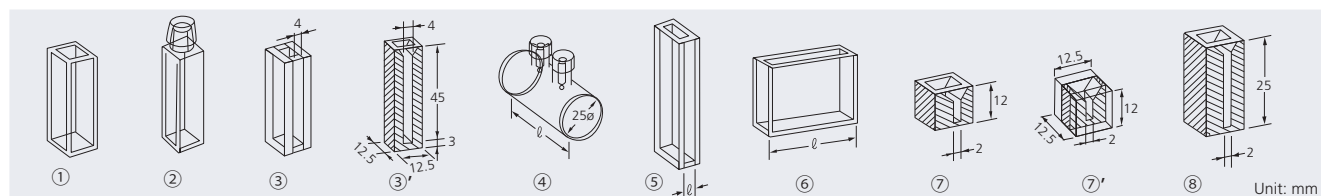

Note *1 With a 5 mm slit, the cell holder with micro cell mask (P/N 204-06896) is required.

*2 The supermicro cell holder (P/N 206-14334) is required.

Options for ISR-1503/1503F

Transmittance small sample holder

(P/N 207-21742-41: for ISR-1503

207-21742-42: for ISR-1503F)

This is a small sample holder to be placed at 0degree transmittance sample port.

Beam size: 4mm diameter

Sample size: 20mm and more



Film holder

(P/N 207-21743-41 : for ISR-1503

207-21743-42 : for ISR-1503F)

This is a film holder to be placed at 0degree transmittance sample port. Maximum 50 x 50 mm film can be held.



Cuvette cell holder

(P/N 207-21741-41: for ISR-1503/1503F)

Measure a cuvette sample. When Rear cover with window (P/N 207-21858-41)

is mounted, sample can be exchanged easily.



Rear cover with window

(P/N 207-21858-41 : for ISR-1503/1503F)

This is used with Cuvette holder. When this is mounted instead of original rear cover of ISR-1503/1503F, sample can be exchanged easily through the window.

Powder sample holder

(P/N 207-21815-41: for ISR-1503

207-21815-42: for ISR-1503F)

Measures reflectance of sample by pressing the powder sample on the holder. It is placed at 0 and 8 degree reflectance sample port.



Hanging sample holder

(P/N 207-21750-41 : for ISR-1503

207-21750-42 : for ISR-1503F)

Measures absorbance of sample by hanging a sample inside of the Integrating sphere.

Standard white plate

This is a reference sample for reflectance measurement. There are two types - BaSO4 and Spectralon.

Material	P/N	Remarks
BaSO4	207-21744-41	for ISR-1503
	207-21744-44	for ISR-1503F
Spectralon	207-21744-43	for ISR-1503
	207-21744-42	for ISR-1503F

Sample holder

(P/N 207-21868-41 : for ISR-1503

207-21868-42 : for ISR-1503F)

Sample with 100g or less can be hold on Reflectance measurement (8°) port. This is used to hold sample, when the sample cannot be held properly by low coefficient of friction.

UVProbe Software

All-In-One Software

UVProbe is an all-in-one software package equipped with the following four functions:

- Spectrum module
- Photometric module (quantitation)
- Kinetics module (time-course measurement)
- Report generator

Each can be easily operated from its own special screen. In addition to a wealth of data processing functions, including peak detection and area calculations, the software is equipped with security functions to configure operational authority user by user, as well as data audit trail and equipment audit trail functionality.

Spectrum Module

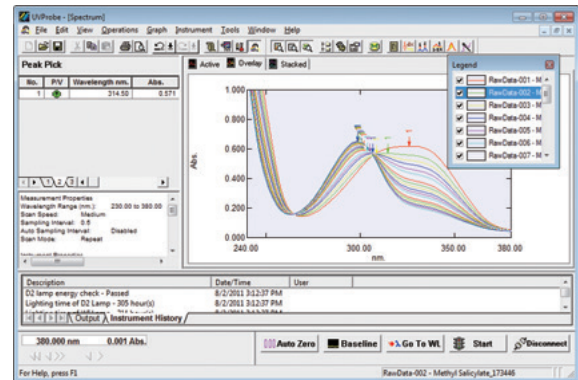

Photometric Module

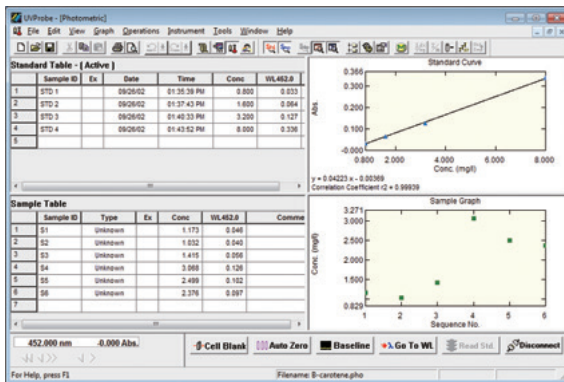

Kinetics Module

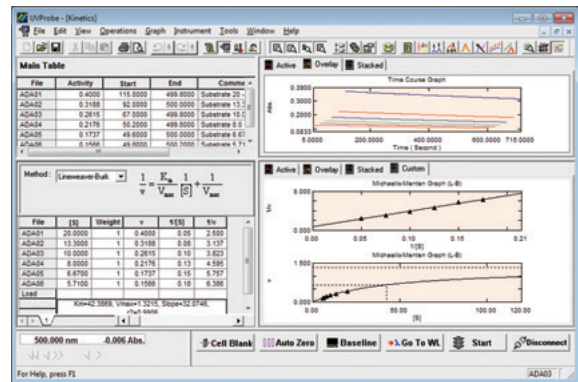

Report Generator

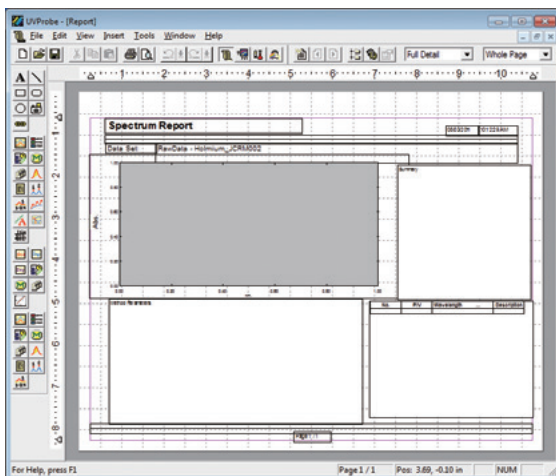

The report generator provides the freedom to arrange graphs, tables, etc. to suit users' needs.

The thickness and color of graph lines, as well as font size, can now be specified. Pasting labels on graphs and editing text is as easy as can be, allowing the user to effectively print comments along with the analysis results.

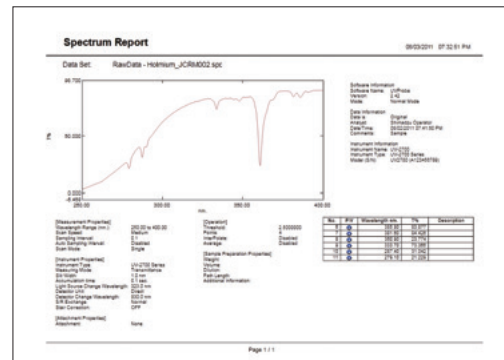

Optional Software

DTL-UVPC Solar Transmittance Measurement Software

(P/N 206-23130-91)

This software calculates the solar transmittance, solar reflectance, visible-light transmittance, and visible-light reflectance of sheet glass and films. It can also calculate some color-related properties (tristimulus values, chromaticity coordinates, dominant wavelength, and excitation purity).

- Create and save custom weighting coefficient tables as files.
- Recalculate existing data after changing standard samples.
- Create custom illumination for color calculations, and save the created illumination as a file.
- Perform white plate correction for highly accurate calculations, and save the white plate reflectance data as a file.
- Graph chromaticity coordinates.

Note: This software runs on Windows 7 Professional.

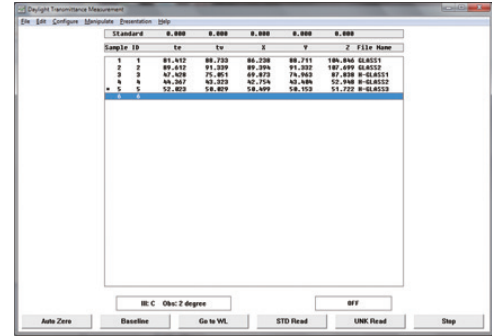

Color Measurement Software

(P/N 206-67449)

This software calculates color values of the measurement sample from the spectrum measured.

- Calculable Items
 - Tristimulus value (XYZ), chromaticity coordinates (xy), Hunter color coordinate system/color difference formula, CIELAB color coordinate system/color difference formula, CIELUB color coordinate system/color difference formula, yellowness/after-yellowing, whiteness, whiteness B (blue reflectance), Munsell, metamerism, three attributes from CIELUB and their difference, primary wavelength, excitation purity.
- The software is fully equipped with convenient graphic functions including chromaticity diagrams and enlarged color-difference views.
- It provides a wealth of recalculation functions, enabling items and conditions with respect to the spectra obtained to be changed for recalculation.
- The visual field (2°, 10°) and the illumination (A, B, C, D65, F6, F8, and F10) are freely selectable. In addition, the user can configure particular weighting coefficients, enabling calculations with respect to any illumination. The configured illumination can also be saved.
- Standard white plate values can be configured, enabling corrected calculations.
- Standard samples can be freely specified, enabling color-difference calculations.
- Thickness conversion calculations are possible with respect to glass, filters, and other transmissive materials.
- The average and standard deviation of multiple data points can be calculated.
- Up to 100 data points can be shown.

Note: This software runs on Windows 10 Professional (64-bit version) or Windows 7 Professional (64/32-bit version).

Measurement window

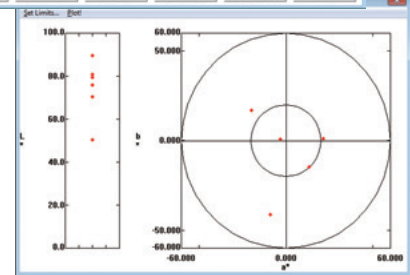
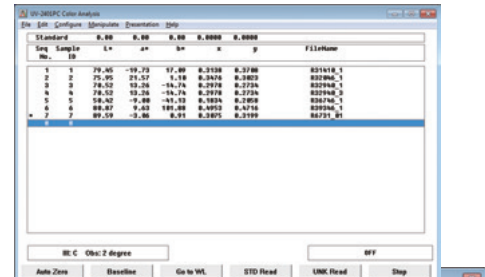

Lab chromaticity diagram display window

Film Thickness Measurement Software

(P/N 206-66877)

This software measures the thickness of thin films from the wavelengths of peak (or valley) interference waveforms overlapping the spectrum.

The film thickness is measured through optical methods without physical contact.

- The film thickness is calculated from linear regression by applying the method of least squares to the wavelengths of the multiple peaks and valleys automatically detected. (The thin film's refractive index and the angle of incidence must be configured as calculation conditions.)
- The calculation conditions can be changed with respect to the measured spectra, enabling recalculation.
- A range can be set for use in the calculations while checking the spectral interference waveform onscreen.
- The measurable film thickness range is (minimum measured wavelength)/n to 50 × (maximum measured wavelength)/n. (Reference value)

Note: This software runs on Windows 10 Professional (64-bit version) or Windows 7 Professional (64/32-bit version).

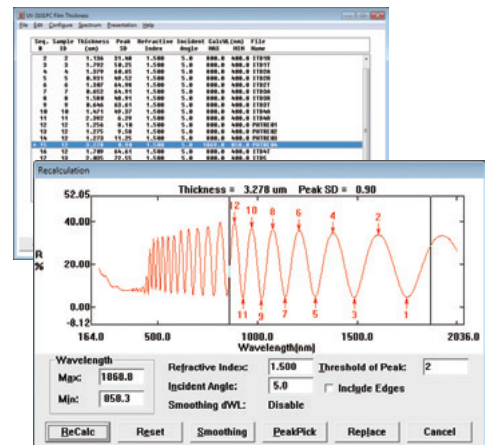

Recalculation window



Shimadzu Corporation
www.shimadzu.com/an/

For Research Use Only. Not for use in diagnostic procedures.

This publication may contain references to products that are not available in your country. Please contact us to check the availability of these products in your country.

Company names, products/service names and logos used in this publication are trademarks and trade names of Shimadzu Corporation, its subsidiaries or its affiliates, whether or not they are used with trademark symbol "TM" or "®".

Third-party trademarks and trade names may be used in this publication to refer to either the entities or their products/services, whether or not they are used with trademark symbol "TM" or "®".

Shimadzu disclaims any proprietary interest in trademarks and trade names other than its own.

The contents of this publication are provided to you "as is" without warranty of any kind, and are subject to change without notice. Shimadzu does not assume any responsibility or liability for any damage, whether direct or indirect, relating to the use of this publication.