

Brand New
7th generation

Flagship model
High performance Tunable Laser
TSL-770



Santec has brought all its experience and knowledge gained over the past 30 years to its all-new 7th generation tunable laser. The TSL-770 is a very high specification tunable laser with flexibility in operation to ensure suitability for a wide range of applications. A ground up redesign of the laser cavity together with ultra-low noise electronics combine to provide market leading scan speed, high optical power, wide tuning range, low noise and narrow linewidth in the same laser. The new proprietary cavity design enhances Q-factor and wavelength stability enabling accurate measurements in even the most cutting-edge research applications.

Measurement Data

Linewidth

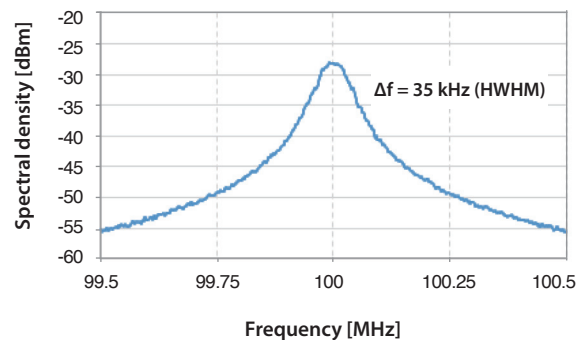

Features

- ▶ Wide tuning range from 1480-1640 nm
- ▶ Mode-hop-free continuous tuning
- ▶ Fast, up to 200 nm/s, wavelength sweeps
- ▶ High output power +13 dBm
- ▶ High signal-to noise ratio 90 dB/0.1 nm
- ▶ High wavelength accuracy 0.3 pm (typ.)
- ▶ Narrow linewidth < 60 kHz

Applications

- ▶ Optical component & photonics material characterization
- ▶ Fiber optic transmission testing (Carrier LD, Local oscillator, etc.)
- ▶ Interferometry, Spectroscopy, Metrology (OFDR, Gas sensing, Terahertz generation, etc.)

Technologies & typical performance

Wide tuning range

The TSL-770 adopts the Littman-Metcalf configuration to achieve a mode-hop-free tuning range of 160 nm. The drive mechanism is robust to ensure long term performance, and is isolated to eliminate acoustic and mechanical noise in the laser.

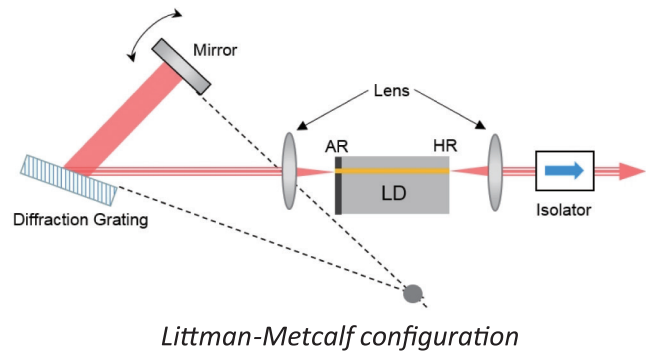
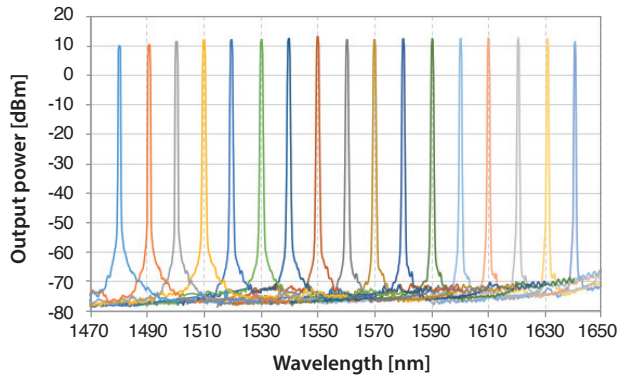

High S/N and high power

An innovative external cavity design has been implemented to lower the optical SSE noise, leading to a high signal-to-noise ratio of over 90 dB/0.1 nm while still maintaining a high output power of up to +13 dBm. It is ideal for next generation components testing driven by extremely high dynamic range filters and Wavelength Selective Switches (WSS).

High power and high signal-to-noise ratio

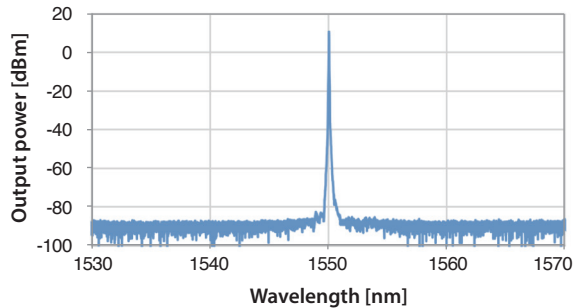

Built-in high performance wavelength meter

The TSL-770 includes a built-in high performance wavelength meter with an absolute wavelength accuracy of ± 2 pm and stores (logs) wavelength data when in continuous sweep mode.

Wavelength accuracy

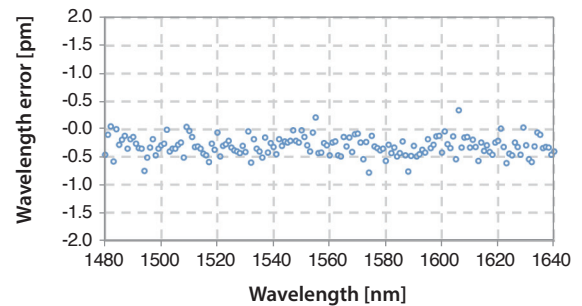

Narrow linewidth & low jitter

The Q-value of the laser cavity has been maximized by isolating the optical cavity from mechanical vibrations. This results in ultra-narrow laser linewidth and market leading wavelength stability.

Linewidth

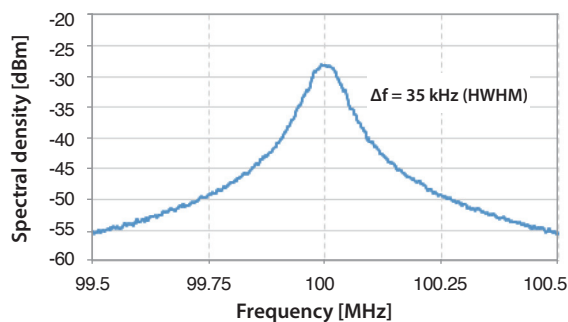

Rapid sweep technology

Santec's advanced optomechanical design enables fast sweeps, up to 200 nm/s with high precision and repeatability. Acceleration and deceleration periods are minimized to further reduce the measurement time for repeated scans.

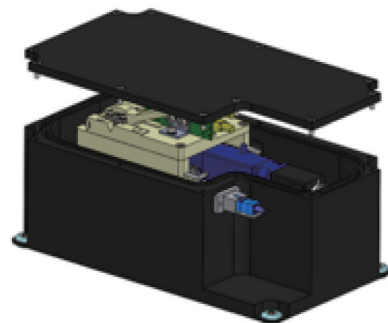

■ Specifications

Category	Parameter		Unit	Performance		
Wavelength Characteristics	Wavelength Tuning Range		nm	SCL-band: 1480-1640 (160 nm) CL-band: 1490-1630 (140 nm)		
	Wavelength Setting Resolution		pm	0.1		
	Wavelength Absolute Accuracy ^{*1}	Operating Temperature		pm	± 2	
		25±1 °C (typ.)		pm	± 0.5	
	Wavelength Repeatability ^{*1}		pm	± 1 (± 0.3 (typ.))		
	Wavelength Stability (typ.) ^{*2}		pm	< ± 1		
Sweep Speed			nm/sec	0.5 to 200		
Optical Power Characteristics	Output Power	Peak (typ.)	dBm	≥ 13	≥ 13	
		>10dBm range	dBm	≥ 10 (1500-1630)	≥ 10 (1500-1630)	
		Full Tuning Range	dBm	≥ 7	≥ 8	
	Power Repeatability ^{*1, *3}		dB	± 0.01		
	Power Stability ^{*2}		dB	± 0.01		
	Power Flatness vs. Wavelength ^{*1, *3}		dB	± 0.2		
Relative Intensity Noise (RIN) (typ.) ^{*4}			dB/Hz	-145 (1 MHz to 3 GHz)		
Spectrum	Linewidth (typ.)	Coherence Ctrl. Off	kHz	60		
		Coherence Ctrl. On	MHz	40		
	SMSR (typ.)		dB	≥ 50		
	Signal to Total Source Spontaneous Emission Ratio ⁵		dB	≥ 70		
	Signal to Source Spontaneous Emission Ratio ⁶		dB/nm	≥ 80 (≥ 90 dB/0.1 nm)		
Interface	Optical Output Connector		-	FC or SC, SPC or APC		
	Optical Fiber		-	PMF ^{*7}		
	Communication		-	GP-IB (IEEE 488.2), USB, Ethernet		
Modulation	LF Modulation		kHz	DC to 400 (typ.)		
	RF Modulation (option)		MHz	2 to 100 (typ.)		
Environmental Conditions and others	Operating	Temperature	°C	15 to 35		
		Humidity	%	< 80 (non-condensing)		
	Power Supply		-	AC 100-240 V ± 10 %, 50/60 Hz		
	Dimensions (W) x (D) x (H) (Except for the protrusion)		mm	440 x 416 x 133		
Weight			kg	16		

* All specifications are quoted after 1 hour warm-up period. Specifications apply for wavelengths not equal to any water absorption line.

*1: At static condition or "Step" sweep mode.

*2: For period of 1 hour. Within ± 0.5 °C.

*3: At "Auto" power mode.

*4: At maximum output power.

*5: Ratio of signal power to total spontaneous emission power within ± 15 nm of the signal wavelength (typical value).

*6: Ratio of signal power to maximum spontaneous emission power in a 1nm band within a ± 3 nm band around the signal wavelength (typical value).

*7: Polarization axis in alignment with connector key. Polarization extinction ratio is 17 dB (typical value).

Typical Swept Test system configuration

IL/PDL measurement setup with the polarization controller PCU-100 and the power meter MPM-210

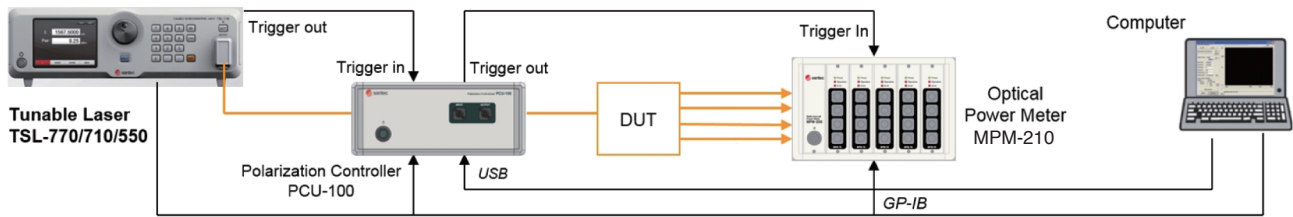

IL measurement setup with the power meter MPM-210

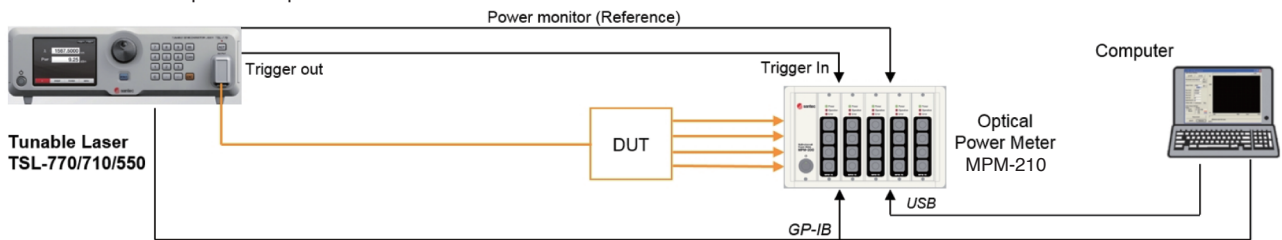

The TSL-770 has an internal power monitor that can be used to compensate output power fluctuation in real time. This eliminates the need to take an optical power reference and reduces the number of power meters required in a measurement system.

The laser integrates with Santec's power meter, MPM-210, and polarization controller unit, PCU-100, to create a turn-key WDL or PDL measurement solution. Santec provides software to control the system, as well as dynamic link libraries (DLLs) to enable system integration and control with a variety of programming languages.

Model selection

Model Number	Wavelength Range
480640	1480 1640
490630	1490 1630

Other wavelength range model is available on request. Please contact Santec Sales.

Laser safety information



This product is classified class 1M laser product according to IEC 60825-1 (2007). This product complies with FDA performance standards for laser products except for deviations pursuant to Laser Notice No. 50 dated June 24, 2007.

Ordering Code

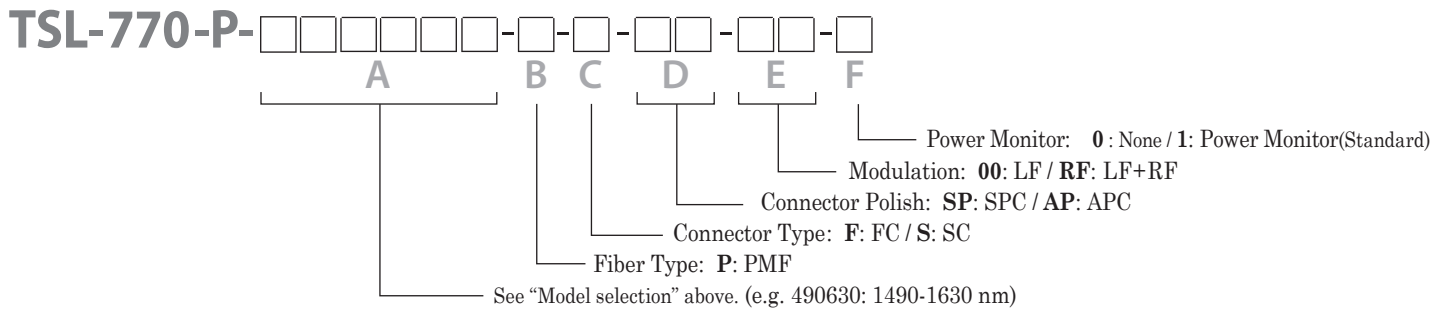

www.santec.com E-Mail : sales@santec.com



SANTEC CORPORATION
5823 Ohkusa-Nenjozaka, Komaki, Aichi 485-0802, Japan Tel. +81-568-79-3536 Fax +81-568-79-1718

SANTEC U.S.A. CORPORATION
433 Hackensack Ave., Hackensack, NJ, 07601, U.S.A. Toll Free +1-800-726-8321 (santec-1) Tel. +1-201-488-5505 Fax +1-201-488-7702

SANTEC EUROPE LIMITED
Grand Union Studios, 332 Ladbroke Grove, London W10 5AD, U.K. Tel. +44-20-3176-1550

SANTEC (SHANGHAI) Co., Ltd.
11F Room E, Hua Du Bldg., No.838 Zhangyang Road, Pudong District, Shanghai 200122 China Tel: +86-21-58361261, +86-21-58361262 Fax: +86-21-58361263