

DR1-D2048x1088-192-G2

The Double Rate camera series DR1-D2048x1088(I/C)-G2 is based on the CMOSIS CMV2000 CMOS image sensor

Features

- Double Rate Technology
- CMOSIS CMV2000 CMOS image sensor
- 2048 x 1088 pixel resolution
- Good NIR spectral response
- Suitable for standard and low light applications
- Up to 85fps @ full resolution
- Global shutter
- Available in monochrome, NIR and color
- Extended sensor and camera features
- Boardlevel and OEM solution available
- GigEVision interface



GigE[®]
VISION
GEN*i*CAM

Quantum Efficiency Image Sensor

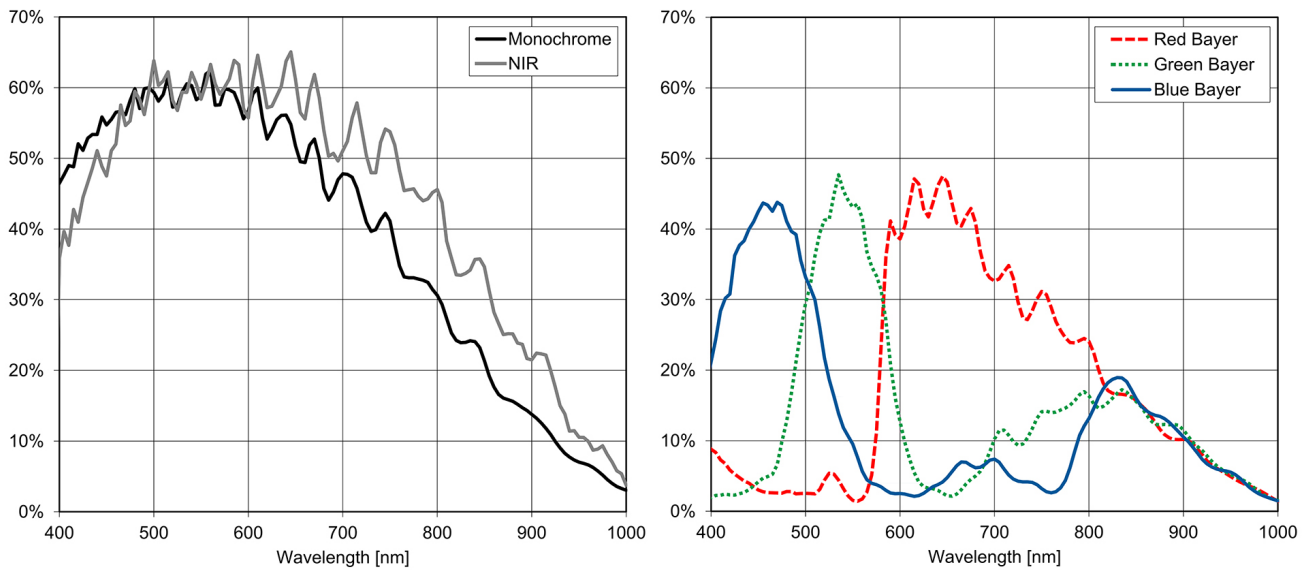

Image Sensor Specifications

Manufacturer / Type	CMOSIS / CMV2000
Technology	CMOS
Optical format	2/3"
Optical diagonal	12.76mm
Resolution	2048 x 1088
Pixel size	5.5µm x 5.5µm
Active optical area	11.26mm x 5.98mm
Dark current	125e ⁻ /s
Read out noise	13e ⁻
Full well capacity / SNR	11ke ⁻ / 105: 1
Spectral range	Monochrome: < 350 to 950nm (to 10% of peak responsivity) NIR: < 350 to 1000nm (to 10% of peak responsivity) Color: < 380 to 670nm (to 10% of peak responsivity)
Responsivity	Monochrome: 1100 x 10 ³ DN / (J/m ²) @ 520nm / 8bit NIR: 900 x 10 ³ DN / (J/m ²) @ 850nm / 8bit Color: 857 x 10 ³ DN / (J/m ²) @ 540nm / 8bit
Quantum Efficiency	Monochrome: > 60% NIR: > 60% Color: > 45%
Optical fill factor	42% without micro lenses
Dynamic range	60dB
Characteristic curve	Linear, Piecewise linear
Shutter mode	Global shutter

Camera Specifications

Interface	GigE
Frame rate	85fps
Pixel clock	64MHz
Camera taps	2
Greyscale resolution	8Bit
Fixed pattern noise (FPN)	< 1DN RMS @ 8Bit
Exposure time range	13µs - 349ms
Analog gain	yes
Digital gain	0.1 to 15.99 (FineGain)
Trigger Modes	Free running (non triggered), external Trigger, SWTrigger, AB-Trigger
Features	Double Rate technology, Configurable region of interest (ROI), Up to 8 regions of interest (MROI), Binning in x- and y-direction, Decimation in y-direction, 2 look-up tables (12-to-8Bit) on user-defined image region (Region-LUT), Constant frame rate independent of exposure time, Crosshairs overlay on the image, Temperature monitoring of camera, Camera informations readable over SDK, Ultra low trigger delay and low trigger jitter, Extended trigger input and strobe output functionality, Status line in picture
Operation temperature / moisture	0°C ... + 50°C / 20% ... 80%
Storage temperature / moisture	-25°C ... 60°C / 20% ... 95%
Power supply	+12VDC (-10%) ... +24VDC (+10%)
Power consumption	< 5.1W
Lens mount	C-Mount (CS-Mount optional)
I/O Inputs	2x Opto-isolated 2x RS-422 Opto-isolated
I/O Outputs	2x Opto-isolated
Dimensions	55 x 55 x 52mm ³
Mass	265g
Connector I/O (Power)	Hirose 12-pole (mating plug HR10A-10P-12S)
Connector Interface	RJ-45
Conformity	CE / RoHS / WEEE
IP Code	IP40

Connectors

Pin	I/O Type	Name	Description
1	PWR	CAMERA_GND	Camera GND 0V
2	PWR	CAMERA_PWR	Camera Power 12V... 24V
3	O	ISO_OUT0	Default Strobe out, internally Pulled up to ISO_PWR with 4k7 Resistor
4	I	ISO_INC0_N	INC0 differential input (G2: RS-422, H2: HTL), negative polarity
5	I	ISO_INC0_P	INC0 differential input (G2: RS-422, H2: HTL), positive polarity
6	PWR	ISO_PWR	Power supply 5V... 24V for output signals
7	I	ISO_IN0	IN0 input signal
8	O	ISO_OUT1 (MISC)	Q1 output from PLC, no Pull up to ISO_PWR; can be used as additional output (by adding Pull up) or as controllable switch (max. 100mA, no capacitive or inductive load)
9	I	ISO_IN1(Trigger IN)	Default Trigger IN
10	I	ISO_INC1_N	INC1 differential input (G2: RS-422, H2: HTL), negative polarity
11	I	ISO_INC1_P	INC1 differential input (G2: RS-422, H2: HTL), positive polarity
12	PWR	ISO_GND	I/O GND 0V

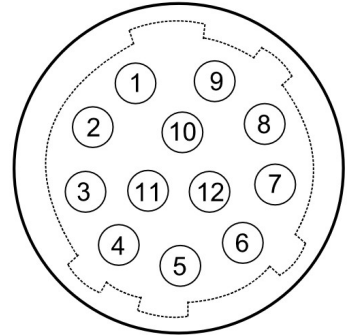

Dimensions

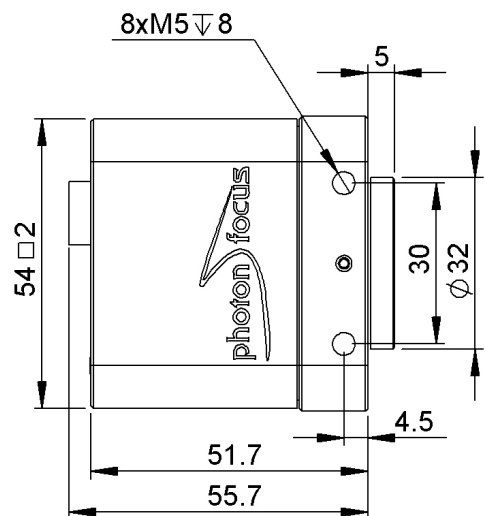
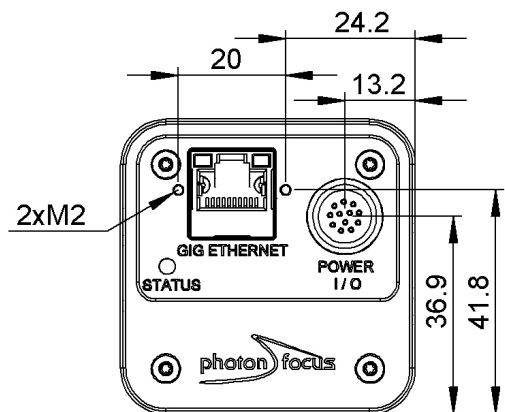
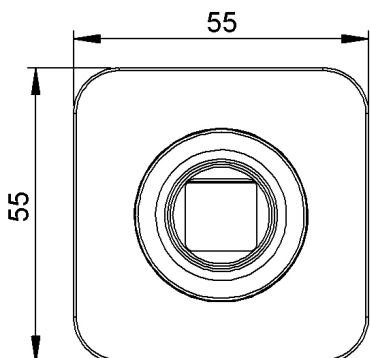
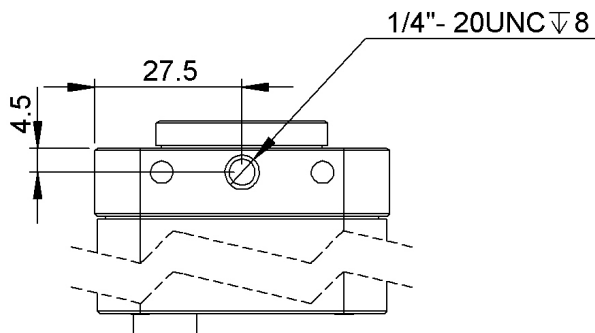

Explanation

DN	DigitalNumber (equals to LSB)
e ⁻	Electrons

Order Information

DR1-D2048x1088-192-G2-8	BW model
DR1-D2048x1088I-192-G2-8	NIR model
DR1-D2048x1088C-192-G2-8	Color model

Compatibility



Photonfocus AG
Bahnhofplatz 10
CH-8853 Lachen SZ
Switzerland

Phone: +41 55 451 00 00
www.photonfocus.com
info@photonfocus.com