



PS24 Pro-Series Laser System

[Overview](#) [Specs](#) [Videos](#) [Downloads](#)

Professional Grade Laser Systems

The next step in precision, power and performance. Designed for industry-scale production and heavy usage output. Now featuring LCD touchscreen controls and the powerful, easy-to-use RetinaEngrave v3.0 laser control software.

 **Interested in a Pro-Series Laser?** ×

Let one of our Technical Sales Associate help you find the right Pro-Series laser for you.

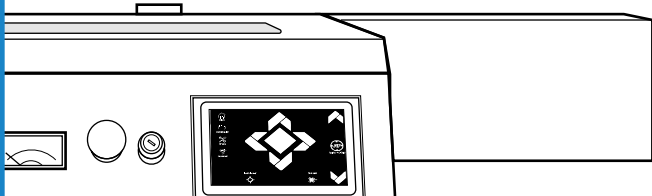

Have a Technical Sales Associate
Contact Me

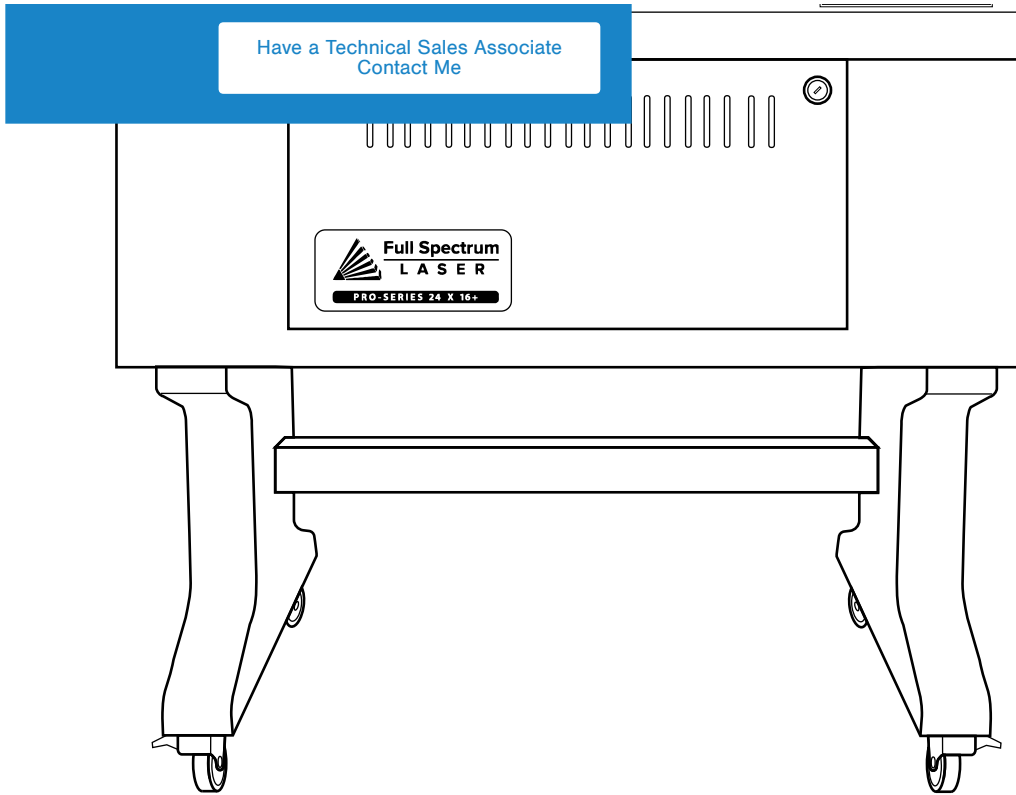

PS24: 90W Laser System

Buy Now (<https://www.fslaser.com/Product/Pro2416/Configurator>)

Starting at \$8,995

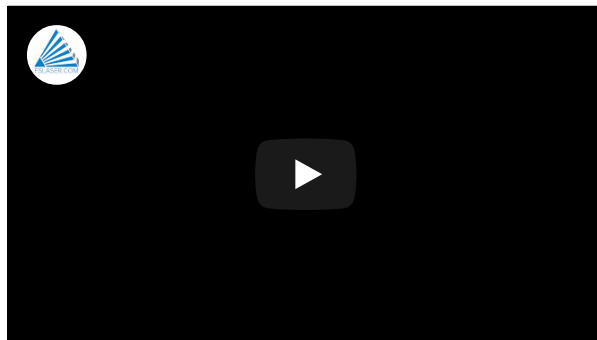

Video Gallery



(<https://www.youtube.com/user/FullSpectrumLasers>)





Newly advanced Professional Grade Laser Systems are now available from Full Spectrum Laser. Exclusive innovations include new, feature-packed LCD touchscreen controls and the powerful, easy-to-use RetinaEngrave v3.0 laser control software, highlighting a full design suite and compatibility with Mac, PC or Linux. The new era of professional grade laser systems has arrived!



This powerful, browser-based software lives right on your laser and is accessed using your favorite browser and operating system. Simply input the IP address of your machine into your browser address bar and you are ready to go. Best part? There's nothing out there like this ever.

**The Best Laser
Control Software
on the Market!**

Welcome to the future of laser control & design software!

More RE3 Info (/re3)





PS24 at a glance

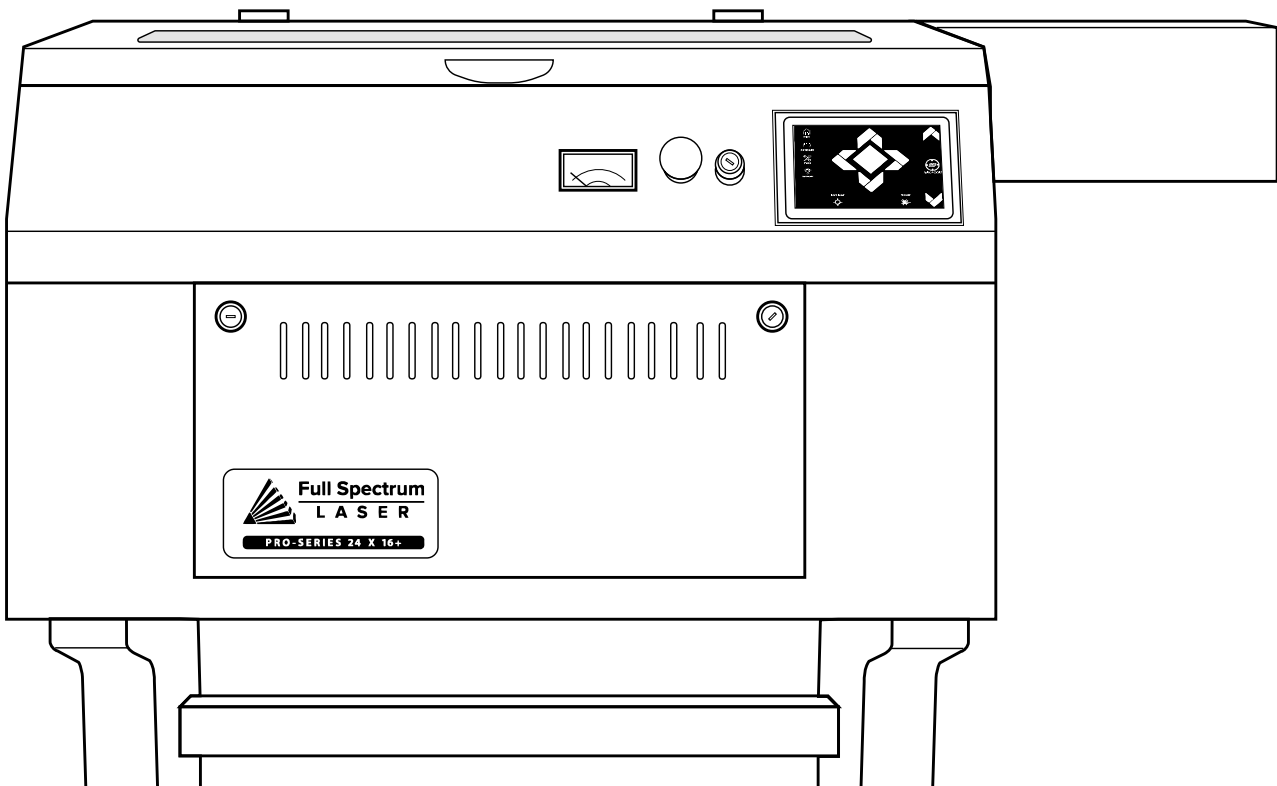

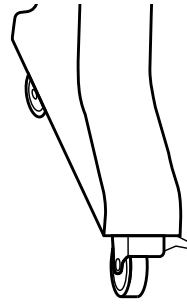
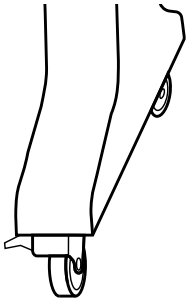

Standard Laser Tube: 90W CO2

Laser Tube Upgrades: N/A

X-Y Working Area: 24" x 16"

Working Z-Height: 6.5"

Motorized Z-Tables: Yes

Pass-Through Doors: Yes

Power Requirements: 120V AC

What's Included

Full Spec Sheet

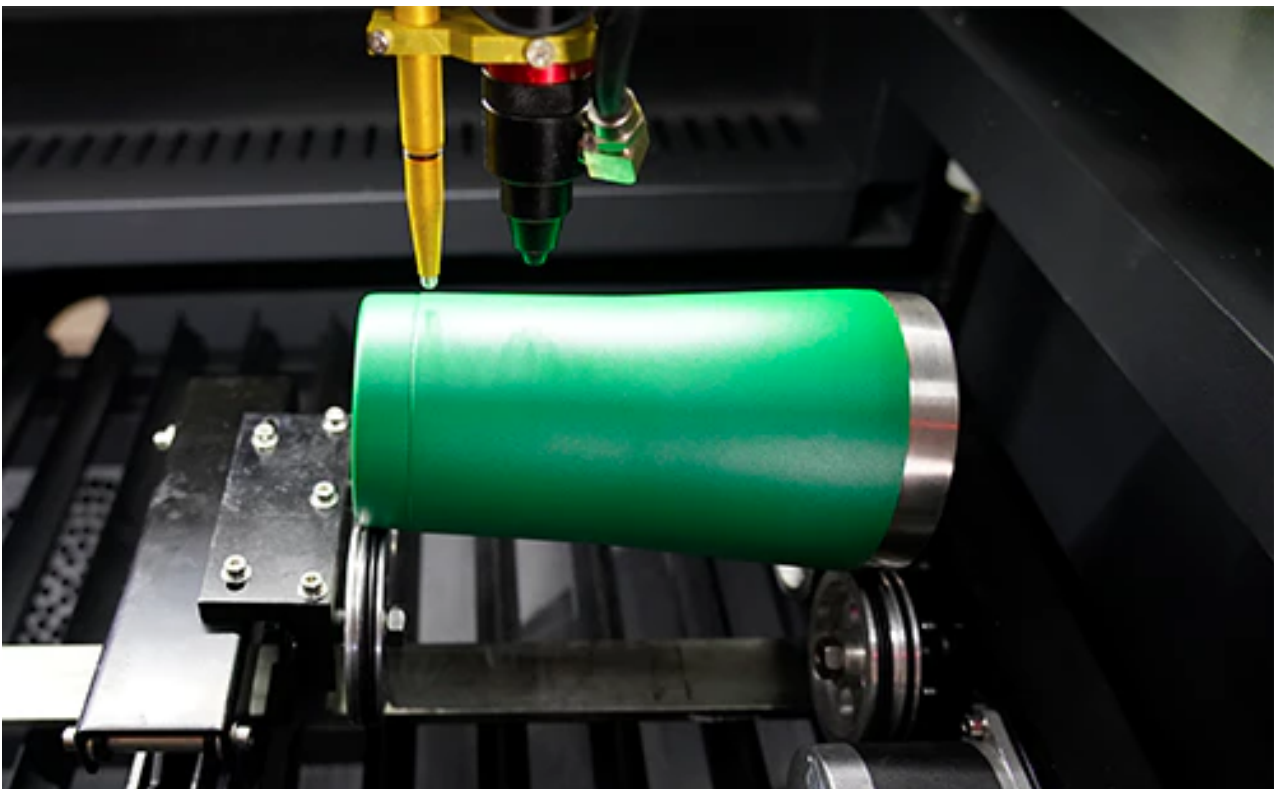



The Perfect Accessories

Engrave curved objects with a rotary attachment. Work with tumblers, glassware and more.

Upgrade your cooling system for peak performance of the laser.

Increase your laser tube power to accelerate cutting speed and marking ability.

...plus fume extractors, specialty focus lenses and more!

Accessories

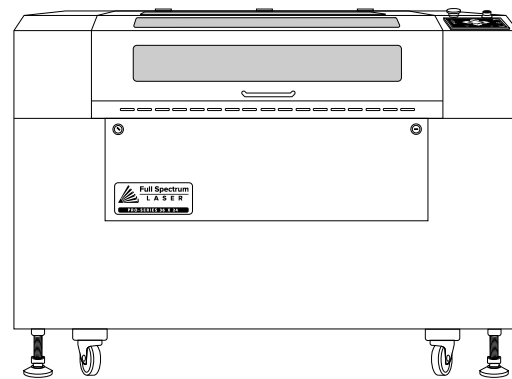
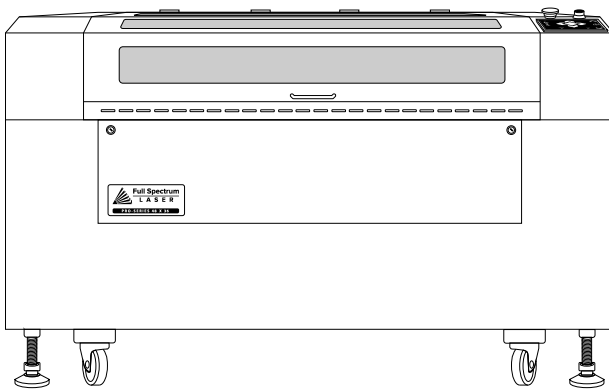
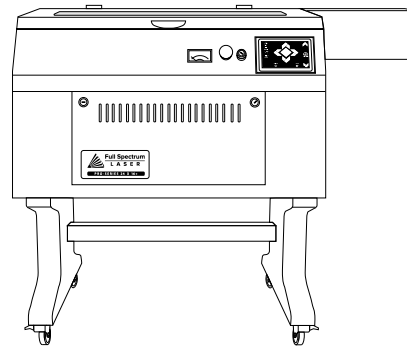
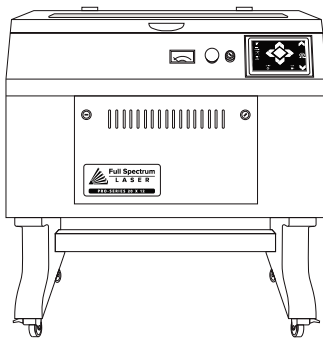

(<https://blog.fslaser.com/pro-series-comparison>)

Pro-Series Comparison (<https://blog.fslaser.com/pro-series-comparison>)



Gallery

Security

LASER 101

Design Assets, Laser Lessons, Certificates, Free Projects, Tips, Techniques & More (<http://laser101.FSLaser.com>)



Tech Specs

WEIGHT & DIMENSIONS

- Engraving Area: 24" x 16" (610mm x 406mm)
- Machine Dimensions: 56" x 31.5" x 36.5" (1420mm x 800mm x 843mm)
- Weight: 260 lbs (110 kg)
- Z-Table Range: 6.5"

LASER

- Laser Classification: Class 3R
- Laser Type: Sealed CO2 Laser Tube
- Laser Power: 90W
- Focus Lens Included: 2.5"

POWER

- Power Supply: AC 110V native (220V option available)
- Gross Power: < 1000W

SYSTEM

- Operation Modes: Precision Raster, Vector or Combined Modes
- Motion Control: High-Speed Stepper Motors
- Operating Temperature: 0C - 45C

CONTROL SOFTWARE

- Software: RotinaEngrave v3.0

- Software: IntraLase v3.0
- Compatibility: PC, Mac & Linux
 - Apple® macOS® X v10.9 or later (Mavericks)
 - Microsoft® Windows® 10
 - Microsoft® Windows® 8.1
 - Microsoft® Windows® 7 SP1
- Browser Compatibility: Google Chrome (recommended), Safari, Firefox, Edge
- Minimum Screen Resolution: 1024 x 768 Pixels
- Ability to Connect Through Local Network (Ethernet or Wireless) without Internet Connection
- Wireless Compatibility: 802.11n

MATERIAL CAPABILITIES

- ½" Wood (Cut/Engrave)
- ½" Acrylic (Cut/Engrave)
- Fabric (Cut/Engrave)
- Cardboard (Cut/Engrave)
- Paper (Cut/Engrave)
- Natural Leather (Cut/Engrave)
- Stone (Engrave only)
- Glass (Engrave only)
- Rubber (Cut/Engrave)

MACHINE FEATURES

- LCD Touchscreen
- Knife Edge Table
- Autofocus Sensor
- Front and Back Pass-Through Doors (24" x 3")
- Motorized Z-table Control
- Keyed Access Panels
- Emergency E-Stop

INCLUDED EQUIPMENT

- 90W Laser Tube
- Radiator Water Chiller
- 2.5" Focus Lens
- Industrial Exhaust Fan
- Air Assist Air Pump

OPTIONAL ACCESSORIES

- Upgrade Cooling System: Refrigerated Water Chiller
 - Upgrade Exhaust System: Large Exhaust Fan; Fume Extractor
 - Specialized Focus Lenses: 1.5"; 2.0"; 5.0"
 - Rotaries: Chuck Rotary; Friction Rotary
-

Videos

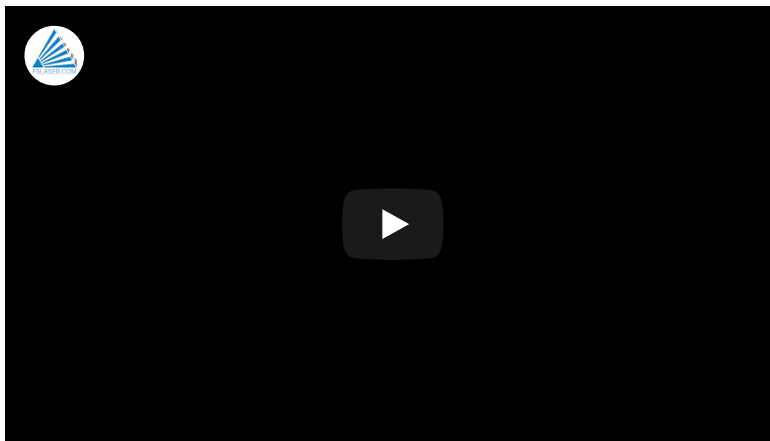
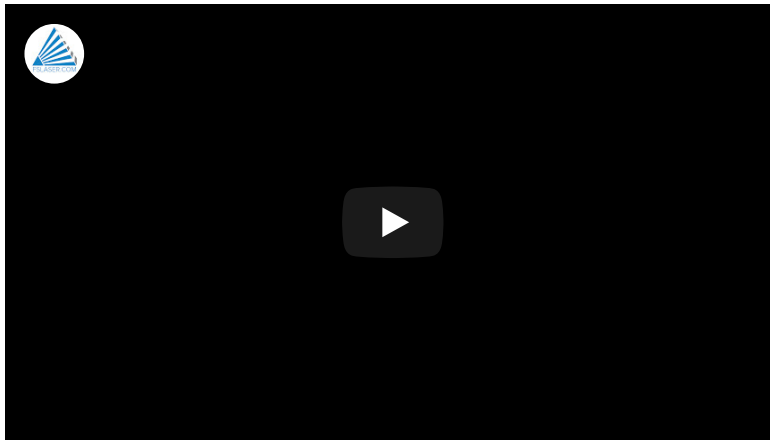
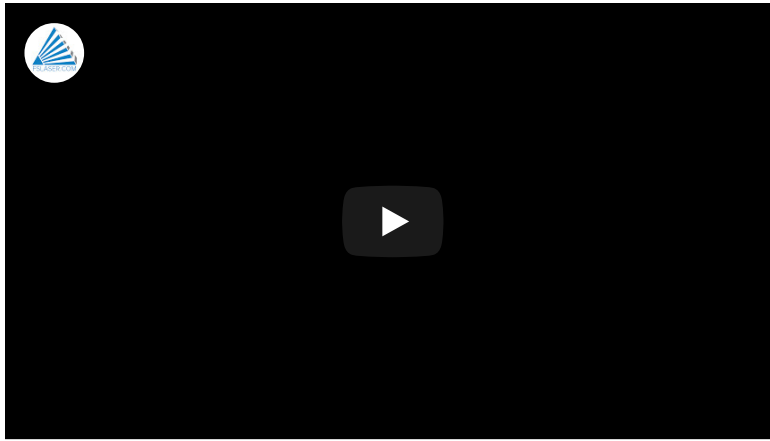

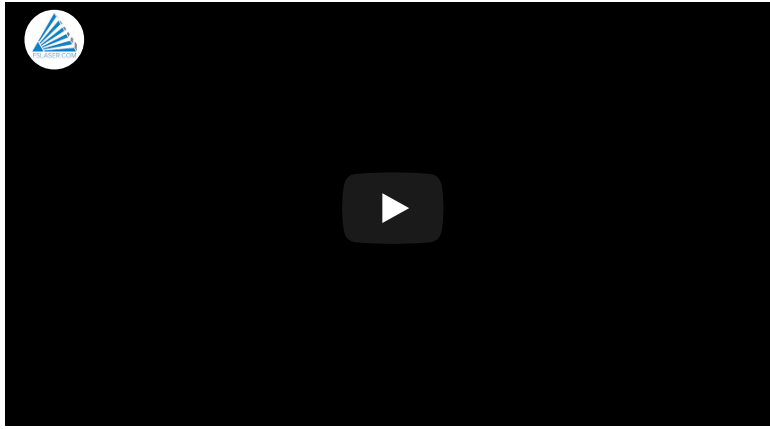

Gallery



[\(/fsl-public.imgix.net/_p_series/ps24/gallery/pro_series_touch_screen.jpg?fm=jpg&auto=format&w=1025&h=683\)](https://fsl-public.imgix.net/_p_series/ps24/gallery/pro_series_touch_screen.jpg?fm=jpg&auto=format&w=1025&h=683)



[\(/fsl-public.imgix.net/_p_series/ps24/gallery/pro_series_touch_screen_close.jpg?fm=jpg&auto=format&w=1025&h=623\)](https://fsl-public.imgix.net/_p_series/ps24/gallery/pro_series_touch_screen_close.jpg?fm=jpg&auto=format&w=1025&h=623)



[\(/fsl-public.imgix.net/_p_series/ps24/gallery/ps36_laser_head.jpg?fm=jpg&auto=format&w=1025&h=683\)](https://fsl-public.imgix.net/_p_series/ps24/gallery/ps36_laser_head.jpg?fm=jpg&auto=format&w=1025&h=683)

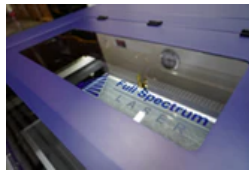

[\(/fsl-public.imgix.net/_p_series/ps24/gallery/ps36_lid_shot.jpg?fm=jpg&auto=format&w=1025&h=683\)](https://fsl-public.imgix.net/_p_series/ps24/gallery/ps36_lid_shot.jpg?fm=jpg&auto=format&w=1025&h=683)

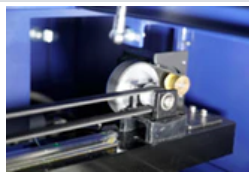

[\(/fsl-public.imgix.net/_p_series/ps24/gallery/ps36_motors.jpg?fm=jpg&auto=format&w=1025&h=683\)](https://fsl-public.imgix.net/_p_series/ps24/gallery/ps36_motors.jpg?fm=jpg&auto=format&w=1025&h=683)



[\(/fsl-public.imgix.net/_p_series/ps24/gallery/ps36_touch_screen.jpg?fm=jpg&auto=format&w=1025&h=683\)](https://fsl-public.imgix.net/_p_series/ps24/gallery/ps36_touch_screen.jpg?fm=jpg&auto=format&w=1025&h=683)

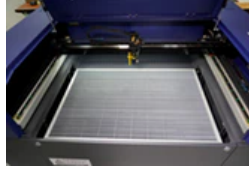

(//fsl-public.imgix.net/_p_series/ps24/gallery/ps36_work_area.jpg?fm=jpg&auto=format&w=1025&h=683)



(//fsl-public.imgix.net/_p_series/ps24/gallery/ps36_work_area_and_laser_head.jpg?fm=jpg&auto=format&w=1025&h=683)

Downloads



Pro-Series Manual

(https://info.fslaser.com/hubfs/Public_Documents/Pro%20Series%20Manual%20PS20&PS24.pdf)



RetinaEngrave v3.0 Manual

(https://info.fslaser.com/hubfs/Public_Documents/RetinaEngrave%20v3.0%20Manual.pdf)

Accessories

All Full Spectrum Laser Systems come complete with all the accessories needed to run your first job as soon as the crate shows up to your location.

Standard Accessories

- Industrial Chiller
- Exhaust Fan
- Air Compressor
- Honeycomb Cutting Surface
- Knife Edge Cutting Surface
- Tool Box





Optional Accessories



(//fsl-public.imgix.net/gen5s/Hobby_Series_Accessories_Focus Lens.png)
1.5" Focus Lens

+ \$250

LEARN MORE (<https://www.fslaser.com/Product/FocusLens1-5in>)



(//fsl-public.imgix.net/gen5s/Hobby_Series_Accessories_Focus Lens.png)
2" Focus Lens

+ \$250

LEARN MORE (<https://www.fslaser.com/Product/FocusLens2in>)



(//fsl-public.imgix.net/gen5s/Hobby_Series_Accessories_Focus Lens.png)
5" Focus Lens

+ \$250

LEARN MORE (<https://www.fslaser.com/Product/FocusLens5in>)



(//fsl-public.imgix.net/_filters/fsl_300_product_shot_web.png)
FSL 300 Fume Extractor

+ \$4,500

LEARN MORE (<https://www.fslaser.com/Product/LargePurifier>)



(//fsl-public.imgix.net/gen5s/Hobby_Series_Accessories_refridgerated_chiller.png)
Advanced Refrigerated Water Chiller

+ \$600

LEARN MORE (<https://www.fslaser.com/Product/AdvancedChiller>)

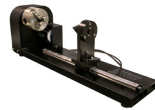

(//fsl-public.imgix.net/accessory_chuck_lg.png)
Chuck Rotary Attachment

+ \$1,000

LEARN MORE (<https://www.fslaser.com/Product/ChuckRotary>)



(//fsl-public.imgix.net/accessory_rotary_lg.png)
Friction Rotary Attachment

+ \$1,000

LEARN MORE (<https://www.fslaser.com/Product/FrictionRotary>)





(//fsl-public.imgix.net/category/lcd_screen.svg)
7" LCD Touch Panel

+ \$1,000

[LEARN MORE \(https://www.fslaser.com/Product/LCD7\)](https://www.fslaser.com/Product/LCD7)

120V Connection

+ \$0

Purchased With Machine

220V Connection

+ \$0

Purchased With Machine



**Extended
Warranty**

(//fsl-public.imgix.net/Ext_Warranty_Icon.png)
2 Year Extended Warranty (excluding consumables/shipping)

+ \$700

Purchased With Machine

6210 S Sandhill Rd, Las Vegas, NV 89120
Tel: 702-802-3100 • sales@fslaser.com (<mailto:sales@fslaser.com>)

© 2019 Full Spectrum Laser. All Rights Reserved.

Tweets by [@FullSpecLaser](#)



Full Spectrum Laser
@FullSpecLaser

We're pushing back FSLTV to tomorrow. Tune it to find out more about the newest addition to the Muse Line, the Muse Vision!



Follow Us

<https://www.facebook.com/fslaser>

<https://www.youtube.com/user/FullSpectrumLasers>

<https://twitter.com/fullspeclaser>

<https://instagram.com/fullspectrumlaser>

<https://www.reddit.com/r/FullSpectrumLaser>