

NL300 SERIES



NL300 series electro-optically Q-switched nanosecond Nd:YAG lasers produce high energy pulses with 3–6 ns duration. Pulse repetition rate can be selected in range of 5–20 Hz.

NL30×HT models are designed for maximum energy extraction from the active element. Up to 1200 mJ pulse energy can be produced at a 5 Hz pulse repetition rate.

A wide range of harmonic generator modules for generation up to a 5th harmonic is available.

Harmonic generators can be combined with attenuators that allow smooth output energy adjustment without changing other laser parameters, i.e. pulse duration, pulse-to-pulse stability, divergence or beam profile. For a more detailed description of harmonic and attenuator modules please check our harmonic generators selection guide on the page 63.

The extremely compact laser head is approximately 480 mm long and can be fitted into tight spaces. The laser power supply has a 330 × 490 mm footprint. Easy access to the water tank from the back side of the power supply facilitates laser maintenance. Replacement of flashlamp does not require removal of pump chamber from the laser cavity and does not lead to possible misalignment.

The powering unit can be configured with water-to-water or water-to-air heat exchangers. The latter option allows for laser operation without the use of tap water for cooling.

For customer convenience the laser can be controlled via a RS232 or USB port with LabView™ drivers (included) or a remote control pad. Both options allow easy control of laser settings.

Compact Flash-Lamp Pumped Q-switched Nd:YAG Lasers

FEATURES

- ▶ Rugged sealed laser cavity
- ▶ Up to **1200 mJ** pulse energy
- ▶ Better than 1 % StDev pulse energy stability
- ▶ **5–20 Hz** pulse repetition rate
- ▶ **3–6 ns** pulse duration
- ▶ Thermo stabilized second, third, fourth and fifth harmonic generator modules
- ▶ Optional attenuators for fundamental and/or harmonic wavelengths
- ▶ Water-to-water or water-to-air cooling options
- ▶ Replacement of flashlamps without misalignment of laser cavity
- ▶ Remote control via keypad and/or RS232/USB port

APPLICATIONS

- ▶ Material processing
- ▶ OPO, Ti:Sapphire, dye laser pumping
- ▶ Laser spectroscopy
- ▶ Remote sensing

SPECIFICATIONS ¹⁾

NEW

Model	NL303HT		NL305HT	
Pulse repetition rate	10 Hz	20 Hz	5 Hz	10 Hz
Pulse energy:				
at 1064 nm	800 mJ	700 mJ	1200 mJ	1100 mJ
at 532 nm ²⁾	380 mJ	320 mJ	700 mJ	500 mJ
at 355 nm ³⁾	250 mJ	210 mJ	450 mJ	320 mJ
at 266 nm ⁴⁾	80 mJ	60 mJ	120 mJ	100 mJ
at 213 nm ⁵⁾	13 mJ	10 mJ	25 mJ	20 mJ
Pulse energy stability (StdDev) ⁶⁾				
at 1064 nm			1 %	
at 532 nm			1.5 %	
at 355 nm			3 %	
at 266 nm			3.5 %	
at 213 nm			6 %	
Power drift ⁷⁾	±2 %			
Pulse duration ⁸⁾	3–6 ns			
Polarization	vertical, >90 %		vertical, >90 %	vertical, >65 %
Optical pulse jitter ⁹⁾	<0.5 ns rms			
Linewidth	<1 cm ⁻¹			
Beam profile ¹⁰⁾	Hat-Top in near and near Gaussian in far fields			
Typical beam diameter ¹¹⁾	~8 mm		~10 mm	
Beam divergence ¹²⁾	<0.6 mrad			
Beam pointing stability ¹³⁾	50 μrad rms			
Beam height	68 mm			

PHYSICAL CHARACTERISTICS

Laser head size (W × L × H) ¹⁴⁾	154 × 475 × 128 mm			
Power supply unit (W × L × H)	330 × 490 × 585 mm			
Umbilical length	2.5 m			

OPERATING REQUIREMENTS

Water consumption (max 20 °C) ¹⁵⁾	<8 l/min	<12 l/min	<6 l/min	<10 l/min
Ambient temperature	15–30 °C			
Relative humidity	20–80 % (non-condensing)			
Power requirements ^{16) 17)}	208–240 V AC, single phase 50/60 Hz			
Power consumption ¹⁸⁾	<1 kVA	<1.5 kVA	<1 kVA	<1.5 kVA

¹⁾ Due to continuous improvement, all specifications are subject to change without notice. The parameters marked typical are not specifications. They are indications of typical performance and will vary with each unit we manufacture. Unless stated otherwise all specifications are measured at 1064 nm.

²⁾ With H300SH, H300S or H300SHC harmonic generator modules. See harmonic generator selection guide on the page 63 for more detailed information.

³⁾ With H300THC, H300STH and H300ST harmonic generator modules. See harmonic generator selection guide on the page 63 for more detailed information.

⁴⁾ With H300SH and H400FHC harmonic generator modules. See harmonic generator selection guide on the page 63 for more detailed information.

⁵⁾ With H300FIHC harmonic generator module. See harmonic generator selection guide on the page 63 for more detailed information.

⁶⁾ Averaged from pulses, emitted during 30 sec time interval.

⁷⁾ Measured over 8 hours period after 20 min warm-up when ambient temperature variation is less than ±2 °C.

⁸⁾ FWHM.

⁹⁾ Relative to SYNC OUT pulse.

¹⁰⁾ Near field (at the output aperture) TOP HAT fit is >70%.

¹¹⁾ Beam diameter is measured at 1064 nm at the 1/e² level.

¹²⁾ Full angle measured at the 1/e² level.

¹³⁾ Beam pointing stability is evaluated as movement of the beam centroid in the focal plane of a focusing element.

¹⁴⁾ See harmonic generator selection guide on the page 63 for harmonic generators units sizes.

¹⁵⁾ For water cooled version. Air cooled version does not require tap water for cooling.

¹⁶⁾ Power requirements should be specified when ordering.

¹⁷⁾ 110 V AC powering is available, please inquiry for details.

¹⁸⁾ Required current rating can be calculated by dividing power value by mains voltage value.



OPTIONAL HARMONIC GENERATOR AND ATTENUATOR MODULES

The following are suggested optimal configurations of H300 series modules for various output wavelengths:

1. For **2nd harmonic** output only: the H300SHC module.
2. For **2nd and 3rd harmonic**:
 - a) H300SH+H300S+H300THC – for SH and TH output as specified in the NL300 series brochure.
 - b) H300STH+H300ST – a cost-effective solution not requiring the replacement of modules when changing from a 532 nm to 355 nm beam and vice versa. The 532 nm beam specification will, however, be 15% lower relative to the values in the NL300 series brochure due to extra components in the beam path.
3. For **2nd and 4th harmonic**: H300SH+H300S+H300FHC modules.
4. For **all harmonic including 4th**:
 - a) H300STH+H300ST+H300FHC – a cost-effective solution. The 266 nm and 532 nm beam specifications will be 15% lower relative to the values in the NL300 series brochure.
 - b) H300SH+H300S+H300THC+H300FHC – a slightly more expensive solution with output values adhering to those in the NL300 series brochure.
5. For **all harmonic including 5th**: modules described in paragraph #4 plus the H300FiHC module.
6. For **attenuators** for all wavelengths up to the 4th harmonic: H300SH+H300A2+H300TH+H300A3+H300A4 modules.

MODULES SELECTION GUIDE

Module	Description	Output ports	Output pulse energy specifications	Dimensions W×L×H, mm	Extension possible?	Notes
H300SH	Second harmonic generator	Port 1: 1064, 532 nm	N/A	154×160×128	Yes	
H300S	532 nm beam separator	Port 1: 532 nm Port 2: residual 1064 nm	See NL300 specifications for 532 nm beam	154×160×128	No	Should be used with H300SH
H300SHC	Second harmonic generator with 532 nm beam separator	Port 1: 532 nm Port 2: residual 1064 nm	See NL300 specifications for 532 nm beam	154×210×128	No	
H300TH	Third harmonic generator	Port 1: 1064, 532 & 355 nm	N/A	154×160×128	Yes	Should be used with H300SH
H300THC	Third harmonic generator with 355 nm beam separator	Port 1: 355 nm Port 2: residual 1064 & 532 nm	See NL300 specifications for 355 nm beam	154×210×128	No	Should be used with H300SH
H300STH	Second and third harmonic generator	Port 1: 1064, 532 & 355 nm	N/A	154×210×128	Yes	
H300ST	355 nm beam separator	Port 1: 355 nm Port 2: residual 532 nm	See NL300 specifications for 355 nm beam	154×160×128	No	Recommended to use with H300STH
H300FHC	Fourth harmonic generator with 266 nm beam separator	Port 1: 266 nm Port 2: residual 532 nm	See NL300 specifications for 266 nm beam	154×290×128	No	Should be used with H300SH
H300FiHC	Fifth harmonic generator with 213 nm beam separator	Port 1: 213 nm Port 2: residual 1064, 532 & 266 nm	See NL300 specifications for 213 nm beam	154×350×128	No	
H300A1	Attenuator for 1064 nm beam	Port 1: 1064 nm beam	Transmission in 5-90% range at 1064 nm	154×210×128	No	
H300A2	Attenuator and beam separator for 532 nm beam	Port 1: 532 nm Port 2: residual 532 nm	Transmission in 5-90% range at 532 nm	154×210×128	No	Should be used with H300SH
H300A3	Attenuator and beam separator for 355 nm beam	Port 1: 355 nm Port 2: residual 355 nm	Transmission in 5-90% range at 355 nm	154×210×128	No	Should be used with H300TH or H300STH
H300A4	Fourth harmonic generator, beam separator and attenuator for 266 nm beam	Port 1: 266 nm Port 2: residual 266 nm	Transmission in 5-90% range at 266 nm	154×350×128	No	Should be used with H300SH

OPTIONS

- ▶ **Option -AW** – air-cooled power supply option. An adequate air conditioner should be installed in order to keep room temperature stable.
- ▶ **Harmonic generator options** – an extensive selection of harmonic generators up to 5th harmonic.
- ▶ **Attenuator options** allow a smooth change of laser pulse energy, while other laser pulse parameters, such as pulse duration, jitter, pulse-to-pulse stability, beam divergence and profile remain the same.

OUTLINE DRAWINGS

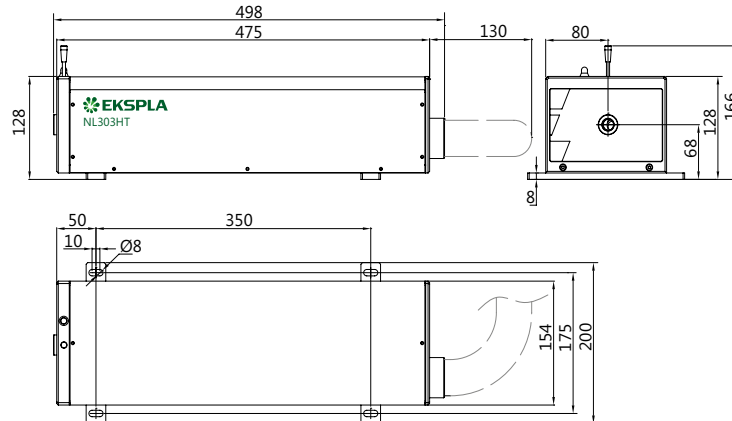
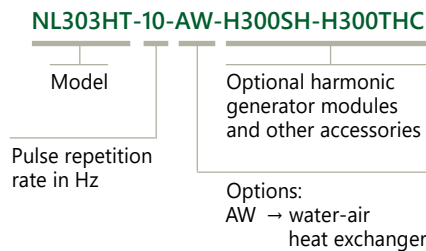

Fig 1. Typical NL300 series laser head outline drawing

ORDERING INFORMATION

Note: Laser must be connected to the mains electricity all the time. If there will be no mains electricity for longer than 1 hour then laser (system) needs warm up for a few hours before switching on.



HARMONIC GENERATORS

Nanosecond Q-switched lasers enable simple and cost effective laser wavelength conversion to shorter wavelengths through harmonic generation. EKSPLA offers a broad selection of wavelength conversion accessories for NL300 series lasers. The purpose of this guide is to help configure available harmonic generator and attenuator modules for NL300 series lasers for optimal performance.

The harmonic module uses a modular design that allows reconfiguration of laser output for the appropriate experiment wavelength.

A typical module houses a non-linear crystal together with a set of dichroic mirrors for separating the harmonic beam from the fundamental wavelength. Nonlinear crystals

used for the purpose of wavelength conversion are kept at an elevated temperature in a thermo-stabilized oven.

Two or more modules can be joined together for higher harmonic generation: attaching one extra module to a second harmonic generator allows for the generation of 3rd or 4th harmonic wavelengths.

It should be noted that only modules with a single output port can be joined together: it is possible to attach a H300S module to a H300SH unit for 532 nm beam separation, or a H300FHC module for 4th harmonic generation (see detailed description below). Modules with two output ports (e.g., H300SHC) cannot be attached to extra units.

For NL300 Series Lasers

FEATURES

- ▶ Compact harmonic modules
- ▶ Thermo stabilized crystals for long lifetime
- ▶ Dichroic mirrors
- ▶ AR coatings on crystals
- ▶ Phase matching by mechanical adjustment
- ▶ High conversion efficiency
- ▶ Wide selection of different configurations

H300SH, H300TH harmonic generators

H300SH or H300TH modules contain a SH or TH crystal with a half-wave plate for input polarization adjustment. The output of the H300SH module has both **532 nm** and **1064 nm** wavelengths; the output of the H300SH+H300TH modules also has a **355 nm** wavelength.

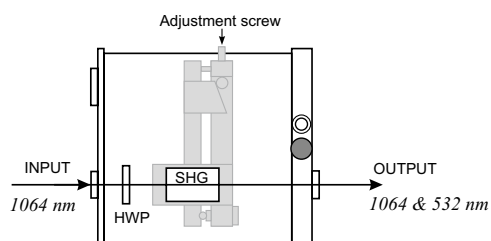

H300SH

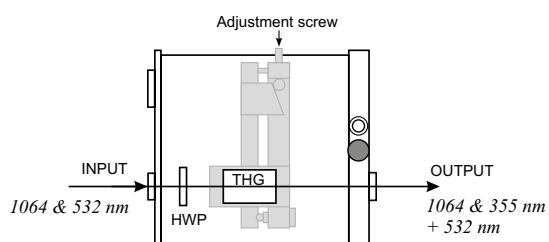

H300TH

H300S harmonic separator

The H300S module has two output ports for the separation of **1064 nm** and **532 nm** wavelengths.

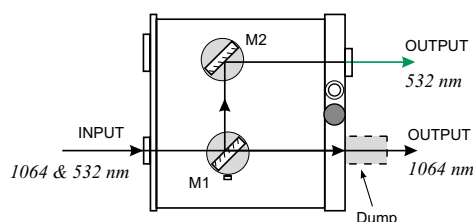

H300S

H300SHC harmonic generator

The most cost-effective solution for customers who need a 532 nm wavelength only, the H300 SHC module combines a SHG crystal and beam separators and has two output ports for 532 nm and 1064 nm beams.

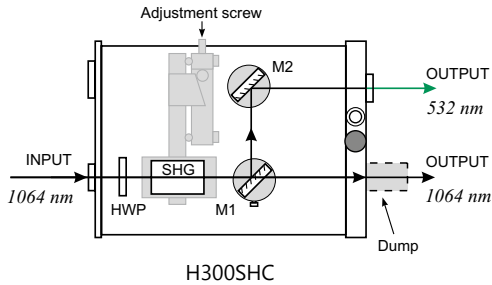

H300SHC

H300THC harmonic generator

The H300THC module is a third harmonic generator and beam separator with two output ports for a 355 nm beam, and for a residual 532 nm + 1064 nm beam. This module should be used with the H300SH module.

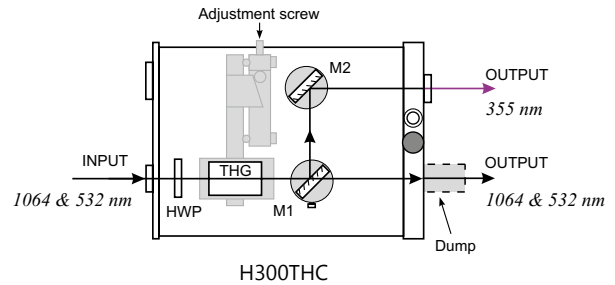

H300THC

H300STH harmonic generator

The H300STH module combined with a H300ST separator module is designed for customers who need a 355 nm wavelength only. The H300STH module has an output port for 355 nm, 532 nm and 1064 nm wavelengths, the H300ST module has two output ports for 355 nm and 532 nm wavelengths. In order to separate 355 nm this module should be used with H300ST.

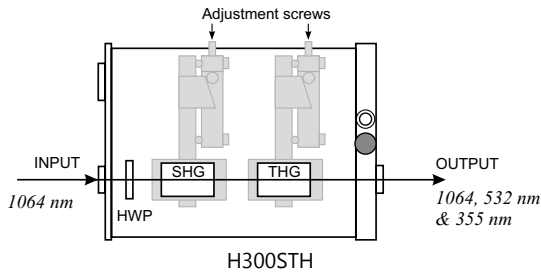

H300STH

H300ST harmonic separator

The H300ST module can be used for the separation of 355 nm and/or 532 nm beams from residual 1064 nm, and can be used together with H300STH, H300TH or H300SH modules.

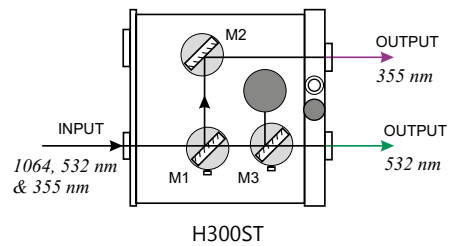

H300ST

H300FHC harmonic generator

The H300FHC module is a fourth harmonic generator and beam separator for a 266 nm wavelength, with two output ports for a 266 nm beam, and for a residual 532 nm beam. This module should be used with the H300SH module.

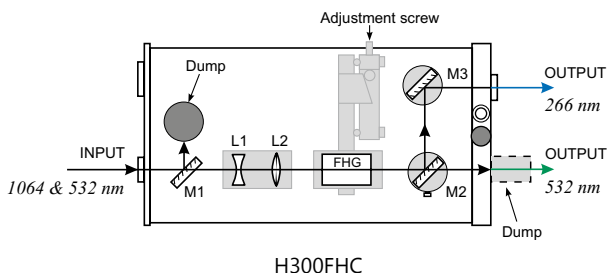

H300FHC

H300FiHC harmonic generator

The H300FiHC module is designed to produce a 5th harmonic output. As it requires only a 1064 nm input, the unit contains SH, FH and FiH crystals together with a beam separator for a 213 nm beam.

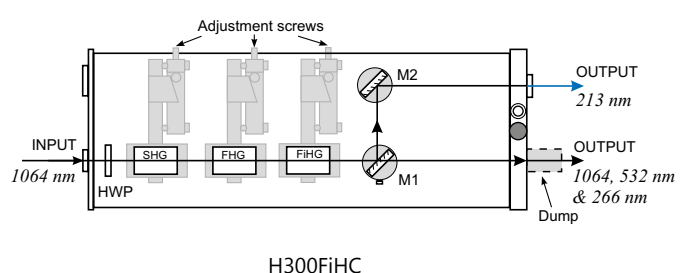

H300FiHC

ATTENUATORS

For NL300 Series Lasers

NL300 series lasers offer several options for changing output pulse energy. The easiest option is to change the timing of the Q-switch opening relative to the flashlamp pump pulse. This option is a standard feature for all NL300 series lasers. A change in Q-switch timing, however, changes other laser pulse parameters along with the pulse energy.

A decrease in pulse energy results in longer pulse duration, decreased pulse-to-pulse stability, and possible changes in the spatial beam profile. For applications that require smooth adjustment of output pulse energy while keeping other parameters stable, EKSPLA offers H300Ax series attenuator modules.

FEATURES

- ▶ Compact design
- ▶ Motorized version is available
- ▶ Smooth adjustment of output pulse energy

H300A1 attenuator

The H300A1 module is designed to attenuate a **1064 nm** beam. Optical layout includes half-wave plates HWP1, HWP2 and polarizers P1, P2 (see picture below). Rotation of the HWP2 half-wave plate changes the polarization of the laser beam and its transmission factor via the P2 polarizer.

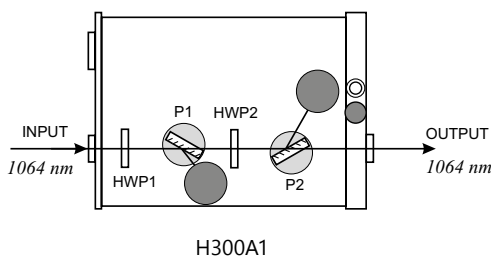

H300A1

H300A3 attenuator

The H300A3 module, designed to attenuate a **355 nm** beam, combines an attenuator with a beam separator and should be used with the H300STH or H300TH modules.

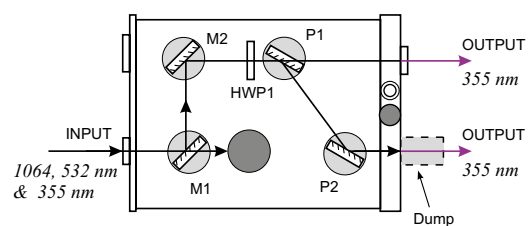

H300A3

H300A2 attenuator

The H300A2 module, designed to attenuate a **532 nm** beam, combines an attenuator with a beam separator and should be used with the H300SH module.

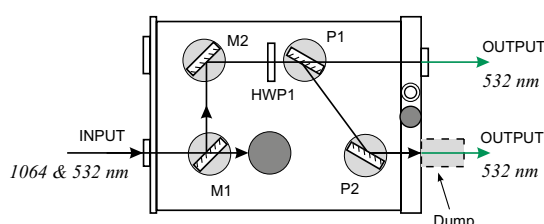

H300A2

H300A4 attenuator

The H300A4 module is designed to attenuate a **266 nm** beam. It combines a FH crystal, beam separator and attenuator and should be used instead of the H300FHC module for attenuation of a 266 nm beam.

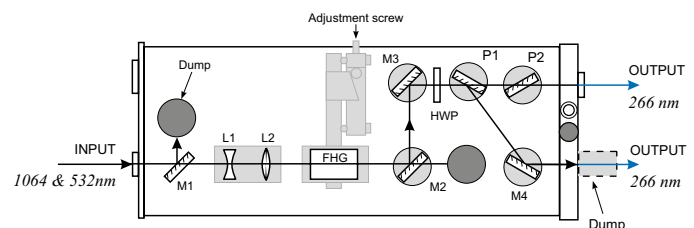

H300A4