



Leica MC170 HD Leica MC190 HD User Manual

Contents

General Notes

General Notes	5
Important Safety Notes	6
Symbols Used	7
Safety Instructions	8

Introduction

Congratulations!	11
Standard Delivery and Optional Accessories	12
Overview of the Instrument	13
Effective Displayed Section	14

Assembly

Assembling the Camera	16
-----------------------	----

Installation

HD Mode (Standalone)	18
Cables and Terminals, Activating HD Mode (Standalone)	18
PC Mode	19
Connecting a Computer, Installing Software, Activating PC Mode	19
Limitations in PC Mode	20

Instrument Setup

Leica MC170 HD or Leica MC190 HD	22
Switching on the Leica MC170 HD or Leica MC190 HD	22
Configuring the Footswitch	23
Remote Control	24
Pairing Cameras With Remotes	26

Application

Switching on the Leica MC170 HD or Leica MC190 HD (Standalone)	28
Information About SD Memory Cards	29
Capturing Images Without a Computer	30
Displaying Images and Videos Without a Computer	31
White Balance	32
Switching on the Leica MC170 HD or Leica MC190 HD (PC Mode)	33
Additional Use of an HD Monitor (PC Mode)	34

Contents (Continued)

User Menu	
Calling up the User Menu	36
Automatic White Balance	37
Manual White Balance	38
Exposure	39
Resolution	40
Camera Settings	42
User-Defined Settings	44
Setting Image Overlays (SETUP OVERLAY)	46
Configuring Predefined Illumination Scenarios	48
Service	
Care, Maintenance, Contact Persons	50
Spare Parts	53
Specifications	
Leica MC170 HD or Leica MC190 HD	55
Dimensional Drawings	57

General Notes

General Notes

Safety concept

Before using your Leica microscope camera for the first time, please read the "Safety Concept" booklet included with your instrument. It contains additional information on handling and care.



Use in clean rooms

The Leica MC170 HD or Leica MC190 HD digital microscope camera can be used in clean rooms without any problems.

Cleaning

- Do not use any unsuitable cleaning agents, chemicals or techniques for cleaning.
- Never use chemicals to clean colored surfaces or accessories with rubberized parts. This could damage the surfaces, and specimens could be contaminated by abraded particles.
- In most cases, we can provide special solutions on request. Some products can be modified, and we can offer other accessories for use in clean rooms.
- Follow the notes regarding cleaning the filter glass in the Service section.

Servicing

- Repairs may only be carried out by Leica Microsystems-trained service technicians. Only original Leica Microsystems spare parts may be used.

Responsibilities of person in charge of instrument

- Ensure that the Leica microscope camera is operated, maintained and repaired by authorized and trained personnel only.

Important Safety Notes

User manual

The Leica MC170 HD or Leica MC190 HD can be configured in a variety of ways in the Leica product range. You can find information on individual system components on the interactive CD-ROM together with all relevant user manuals in additional languages. Keep this CD-ROM in a safe place, where it is available to the user. User manuals and updates are also available for you to download and print from our web site at www.leica-microsystems.com.

This user manual describes the special functions of the Leica MC170 HD or Leica MC190 HD digital microscope camera and contains important instructions for operating safety, maintenance and the accessory parts.

The "Safety Concept" booklet contains additional safety information regarding the service work, requirements and the handling of the microscope camera, accessories and electrical accessories as well as general safety instructions.

You can combine individual system articles with articles from external suppliers (e.g. cold light sources, etc.). Please read the User Manual and the safety instructions from the supplier.

Before installing, operating or using the instruments, read the user manuals listed above. In particular, please follow all safety instructions.

To maintain the unit in its original condition and to ensure safe operation, the user must follow the instructions and warnings contained in these user manuals.

Symbols Used

Warning! Safety hazard!



This symbol indicates especially important information that is mandatory to read and observe. Failure to comply can cause the following:

- Hazards to persons!
- Instrument malfunctions and damage.

Warning of hazardous electrical voltage



This symbol indicates especially important information. Failure to comply can cause the following:

- Hazards to persons!
- Instrument malfunctions and damage.

Instrument malfunctions and damage



This symbol warns against touching hot surfaces, such as light bulbs.

Important information



This symbol indicates additional information or explanations that are intended to provide clarity.

Safety Instructions

Description

- The individual modules fulfill the highest requirements for observation and documentation of the Leica MC170 HD or Leica MC190 HD digital microscope camera.

Intended use

- Refer to "Safety Concept" booklet

Non-intended use

- Refer to "Safety Concept" booklet

Never use the Leica MC170 HD or Leica MC190 HD or its components for surgical procedures (such as eye surgery) if it is not expressly intended for such use.

The instruments and accessories described in this User Manual have been tested for safety and potential hazards.

The responsible Leica affiliate must be consulted whenever the instrument is altered, modified or used in conjunction with non-Leica components that are outside of the scope of this manual!

Unauthorized alterations to the instrument or noncompliant use shall void all rights to any warranty claims.

Place of use

- Refer to "Safety Concept" booklet
- Electrical components must be placed at least 10 cm away from the wall and from flammable substances.
- Avoid large temperature fluctuations, direct sunlight and vibrations. These conditions can distort measurements and micrographic images.

- In warm and warm-damp climatic zones, the individual components require special care in order to prevent the build-up of fungus.

Responsibilities of person in charge of instrument

- Refer to "Safety Concept" booklet

Ensure that:

- The Leica MC170 HD or Leica MC190 HD digital microscope camera and accessories are operated, maintained and repaired by authorized and trained personnel only.
- All operators have read, understood and observe this User Manual, and particularly the safety regulations.

Safety Instructions (Continued)

Repairs, service work

- Refer to "Safety Concept" booklet
- Only original Leica Microsystems spare parts may be used.
- Before opening the instruments, switch off the power and unplug the power cable.
- Avoid contact with powered electrical circuits, which can lead to injury.

Transport

- Use the original packaging for shipping or transporting the individual modules of the Leica MC170 HD or Leica MC190 HD digital microscope camera and the accessory components.
- In order to prevent damage from vibrations, disassemble all moving parts that (according to the user manual) can be assembled and disassembled by the customer and pack them separately.

Integration in third-party products

- Refer to "Safety Concept" booklet

Disposal

- Refer to "Safety Concept" booklet

Legal regulations

- Refer to "Safety Concept" booklet

EC Declaration of Conformity

- Refer to "Safety Concept" booklet

Health risks

Workplaces with microscopes facilitate and improve the viewing task, but they also impose high demands on the eyes and holding muscles of the user. Depending on the duration of uninterrupted work, asthenopia and musculoskeletal problems may occur. For this reason, appropriate measures for reduction of the workload must be taken:

- Optimal arrangement of workplace, work assignments and work flow (changing tasks frequently).
- Thorough training of the personnel, giving consideration to ergonomic and organizational aspects.

The ergonomic optical design and construction of Leica microscopes are intended to reduce the exertion of the user to a minimum.

Introduction

Congratulations!

We congratulate you on purchasing the Leica MC170 HD or Leica MC190 HD digital microscope camera by Leica Microsystems. The special design of the Leica MC170 HD or Leica MC190 HD makes it a universal, highly versatile tool for viewing microscopic specimens and capturing still images or even video.

Real Full HD display

The integrated HDMI output allows the camera image to be output to a high-definition (HD-capable) monitor, where the following resolutions are possible:

- 1,920×1,080 (Full HD). This resolution provides the best possible imaging performance on a Full HD-capable monitor.
- 1,280×720 (HD ready). This resolution is suitable for display on monitors labeled "HD ready" or on smaller monitors with a 10" or 12" diagonal.

Leica Application Suite

Your Leica MC170 HD or Leica MC190 HD digital microscope camera includes the "Leica Application Suite" software. It allows additional scenarios to be implemented in which an HD monitor and computer monitor can even be used together. This means you will be perfectly equipped for any situation, including: Working on a computer, during presentations, training sessions, trade show appearances, during materials testing and more.

User-friendly even in the smallest detail

Like every digital camera, the Leica MC170 HD or Leica MC190 HD microscope camera reacts differently to different light sources. However, the white balance is matched to LED illuminators from Leica at the factory. This means that if you use a Leica LED illuminator, you automatically obtain the best results!

Standard Delivery and Optional Accessories

Standard delivery



Standard delivery of the Leica MC170 HD or Leica MC190 HD digital microscope camera includes:

1. *Leica MC170 HD or Leica MC190 HD digital microscope camera*
2. *Remote control unit, with 2× AAA batteries*
3. *"Leica Application Suite (LAS)" software DVD*
4. *USB cable, for connecting to a computer or to a power supply unit for supplying power*
5. *HDMI cable, for connecting to an HD monitor*
6. *SD memory card*

 Additional information about working on the computer and with Leica Application Suite is provided in the software's online help.

Optional accessories: Handswitch/footswitch

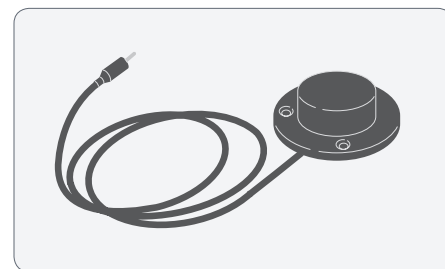

Various functions can be assigned to the optional handswitch/footswitch (such as taking individual pictures, white balance).

For information on additional accessories, such as objectives and adapters, illumination or the dust cover for the microscope, please contact your Leica Microsystems authorized dealer.

 You can find detailed descriptions of different accessories in their corresponding user manual.

Overview of the Instrument

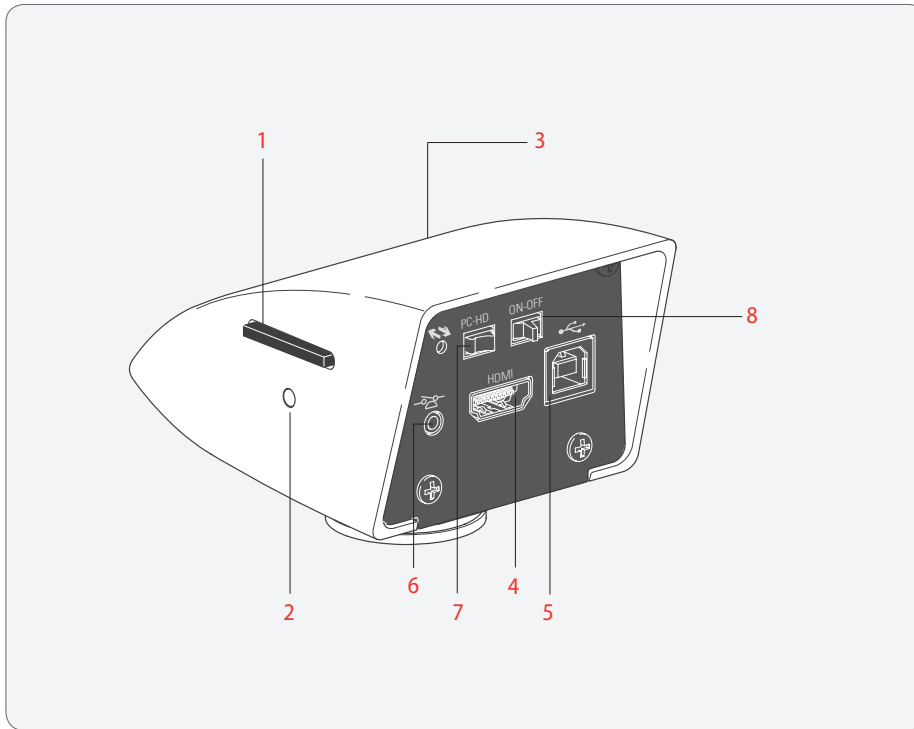

1. Card holder for SD card
2. Status light
3. IR receiver, for remote control
4. HDMI connection
5. USB connection
6. Connection for footswitch
7. Mode switch, for PC or HD mode
8. On/off switch

Effective Displayed Section

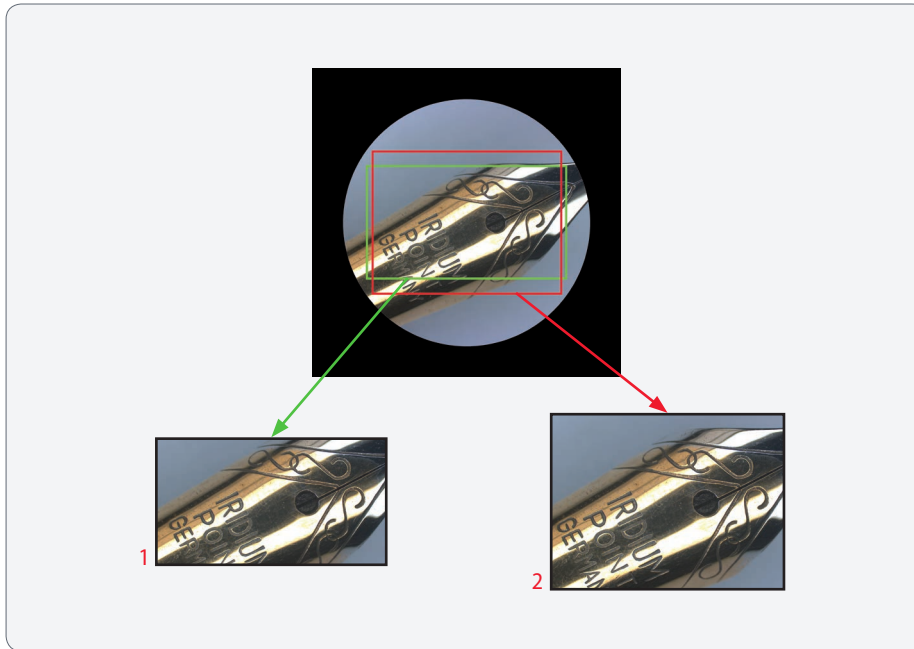



i The live image on the HD monitor and the final image capture may not show the same section depending on the sensor size in the microscope.

1. Live image in 16:9 format, displayed on the HD monitor
2. Image capture in 4:3 format, displayed on the computer or saved to an SD card

Assembly

Assembling the Camera

 The Leica MC170 HD or Leica MC190 HD is mounted on a (trinocular) tube or on a microscope's photo port using a C-mount adapter.

 The Leica MC170 HD or Leica MC190 HD is compatible with all stereo, macro and light microscopes from Leica Microsystems.

Assembly

1. Screw the camera onto a C-mount adapter.

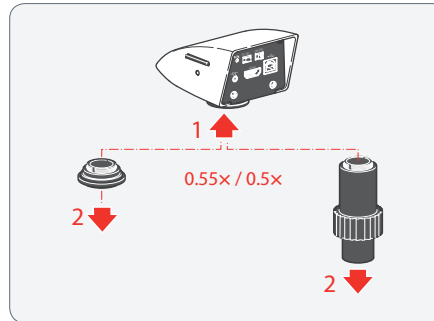

2. Place the camera on the microscope's photo port or the tube using the previously mounted C-mount adapter.

Installation

HD Mode (Standalone)

Cables and Terminals, Activating HD Mode (Standalone)

General notes

 The Leica MC170 HD or Leica MC190 HD is designed for the use of HD-capable (high definition) monitors. We urgently recommend connecting the HD monitor using an HDMI connector and not using a DVI adapter, as otherwise proper function can no longer be guaranteed!

 Please only connect the provided 5 V power supply unit. Using an incorrect voltage can substantially damage the Leica MC170 HD or Leica MC190 HD.

Power supply and HD monitor

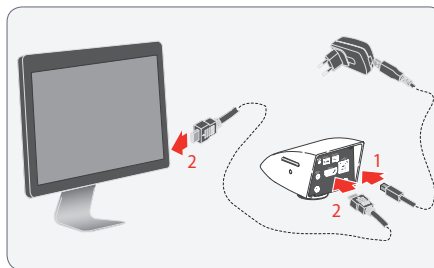

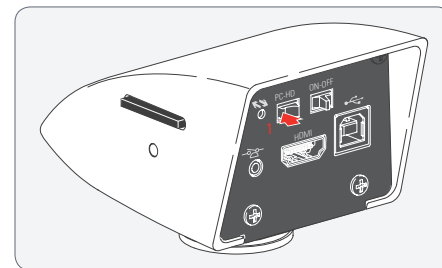

1. Connect the Leica MC170 HD or Leica MC190 HD to a suitable power socket using the USB cable and power supply.
2. Connect the Leica MC170 HD or Leica MC190 HD to the HD monitor using the HDMI cable.

Activating HD mode (standalone)



1. Set the mode switch to "HD" in order to set the Leica MC170 HD or Leica MC190 HD to HD mode (standalone).

 An SD card with sufficient free memory must be inserted into the Leica MC170 HD or Leica MC190 HD in order to save images in HD mode (standalone).

 In order to avoid instrument malfunctions, do not connect the Leica MC170 HD or Leica MC190 HD to a computer while in HD mode (standalone).

PC Mode

Connecting a Computer, Installing Software, Activating PC Mode

Installation and connection

i For instructions on installing and using the software for PC mode, refer to the DVD provided with the Leica MC170 HD or Leica MC190 HD.

1. Place the DVD provided into the computer's disk drive and follow the instructions for installing the software.

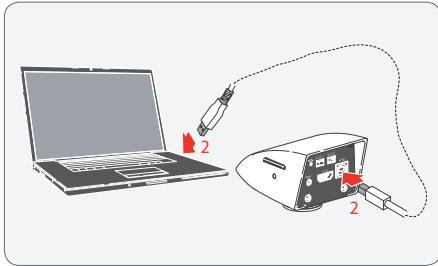

2. Connect the Leica MC170 HD or Leica MC190 HD to the computer using the USB cable.

i The Leica MC170 HD or Leica MC190 HD is powered by the computer via the USB cable. The status light is red when switching on the Leica MC170 HD or Leica MC190 HD; as soon as it is green, you can open the software and view, record or manage images.

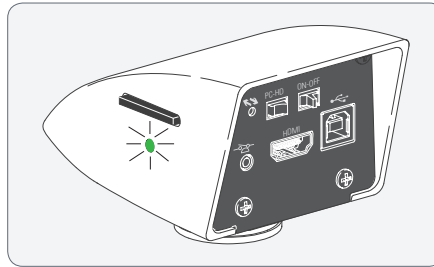

3. Follow the instructions in the software for adjusting and recording an image.

Activating PC mode

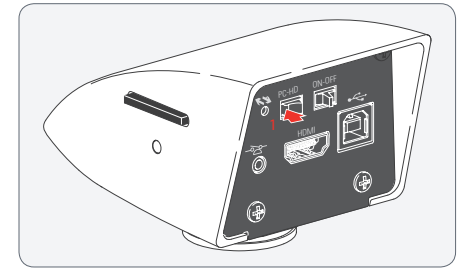



1. Set the mode switch to "PC" in order to set the Leica MC170 HD or Leica MC190 HD to PC mode.

i The Leica software has to be installed on the computer in order to use the Leica MC170 HD or Leica MC190 HD in PC mode. The computer also has to have sufficient free hard drive space.

Limitations in PC Mode

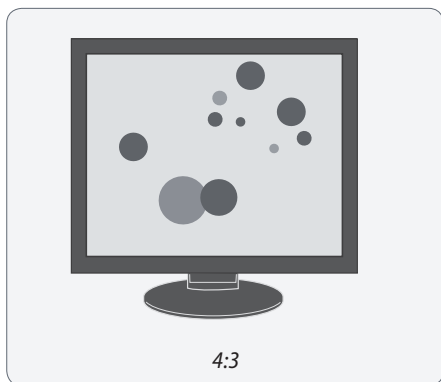

Aspect ratio

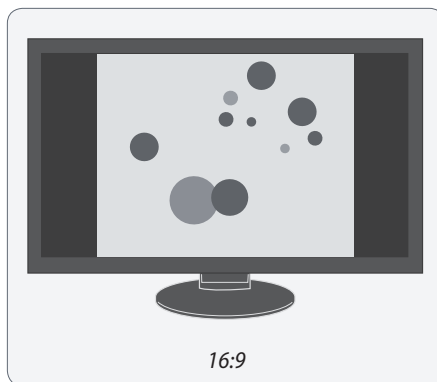

 Images are always output in a 4:3 aspect ratio when the Leica MC170 HD or Leica MC190 HD is connected to a computer – even if a 16:9 monitor is connected to the HDMI port. However, the image is displayed correctly on these kinds of devices, just with black screen edges.



Operation

 The Leica MC170 HD or Leica MC190 HD is controlled entirely via the computer in PC mode. The remote control and the footswitch do not work. The menus for the camera are also not displayed on the HD monitor. Status information can be retrieved at any time despite this by using  on the remote control.

 Images cannot be saved onto the SD card in PC mode.

Instrument Setup

Leica MC170 HD or Leica MC190 HD

Switching on the Leica MC170 HD or Leica MC190 HD

HD mode (standalone)

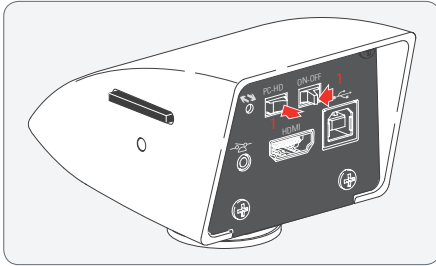

i Ensure that the camera can receive light from the microscope, the mode switch is set to "HD" and the HD monitor is switched on.

1. Set the on/off switch to "ON" to switch on the Leica MC170 HD or Leica MC190 HD.
2. The status light's LED switches from red to green, a signal tone sounds and the live image is displayed on the HD monitor – the Leica MC170 HD or Leica MC190 HD is ready to use.

i If the Leica MC170 HD or Leica MC190 HD is connected to a computer in HD mode (standalone):

- The message "No camera" appears when starting the LAS software.

i If the Leica MC170 HD or Leica MC190 HD is connected to an HD monitor in PC mode:

- The remote control does not respond; in other words, the user menu does not appear.
- On the HD monitor, a live image is shown in 4:3 aspect ratio (with black bars on the right and left).

PC mode

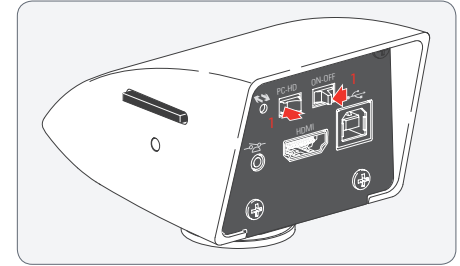

i Ensure that, as with HD mode, the mode switch is set to "PC" and the computer monitor is switched on.

1. Set the on/off switch to "ON" to switch on the Leica MC170 HD or Leica MC190 HD.
2. Start Leica Application Suite.
3. The status light's LED switches from red to green, a signal tone sounds and the live image is displayed on the computer – the Leica MC170 HD or Leica MC190 HD is ready to use.

Configuring the Footswitch

General notes

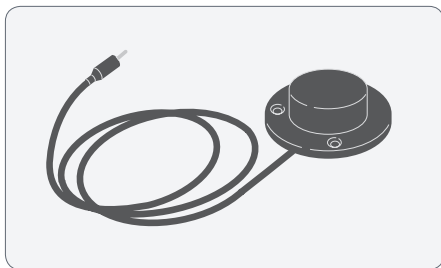

The optional footswitch can be configured as defined by the user using the remote control.

 The default setting is "CAPTURE" for capturing an image.

 The optional footswitch does not work in PC mode.

Configuring

1. Select "SETUP USER" in the main menu:

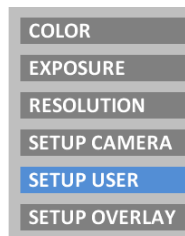

2. Select "FOOT SWITCH" for the footswitch:



3. The following configurations are possible by selecting the corresponding option:

- NONE: No Function
- CAPTURE: Capture an image and save it to the SD card.
- SHOW LAST: Show a preview of the most recently acquired image.
- MOVIE: Start video recording or stop a video recording that is in progress. Saved to the SD card as an MP4 file.
- OVERLAY: Show crosshair or overlay. Pressing this button multiple times scrolls through the list of crosshairs or overlays.
- WHITE BAL: Run white balance for color correcting the camera.

Remote Control

General notes

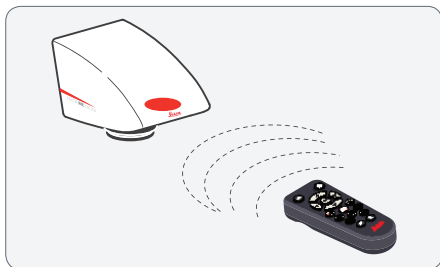

Always keep the remote control for controlling the Leica MC170 HD or Leica MC190 HD pointed towards the camera's IR receiver.



The remote control does not respond if the camera is in PC mode.



Instead of the remote control, the optional footswitch (depending on the configuration) can be used to trigger the Leica MC170 HD or Leica MC190 HD.

Description



1. Start/stop video recording
2. Save still image to SD card
3. Stop/continue live image, pause/play movie clip
4. View files on SD card
5. Move to previous image on SD card
6. Move to next image on SD card
7. Brightness adjustment up or down
8. Pairing button
9. Show/hide information box
10. White balance set button
11. Call up the camera menu
12. Arrow keys for navigation
13. OK to confirm

Remote Control (Continued)

Checking the batteries

1. Switch on the camera and HD monitor so that you see the live image on the HD monitor.

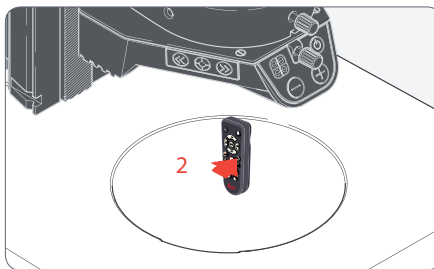

2. Hold the remote control in the beam path so that it faces upwards and press any key.

Because the camera's chip also responds to the infrared range, you can see how the LED on top of the remote control lights up on the HD monitor. If this is not the case, the batteries need to be changed.

Changing the batteries



1. Remove the battery cover on the rear side of the remote control.
2. Replace the batteries (2× AAA) and close the battery cover.



For the battery replacement, you need two (2) type AAA batteries.





You can insert a small piece of foam or a folded piece of paper under the battery cover to ensure better or more reliable battery contact.

Pairing Cameras With Remotes

Pairing

 The Leica MC170 HD or Leica MC190 HD and the remote control can be paired and then only respond to each other. This can be helpful when using multiple cameras and remote controls.



1. Press the  button to start or end the process.

 In order to achieve successful pairing and avoid pairing by mistake, the second step must be performed within 4 seconds.

 If a "timeout" is displayed after 4 seconds, press the "Pair" button again to start the process.

2. Press and hold the button on your remote control representing the channel that you want to assign to the connection (see image to the right, channel selection) until a corresponding confirmation is displayed on the HD monitor. All of the buttons except the  button can be used for this.
3. The microscope only responds to the remote control commands from the remote control used for the pairing.

Resetting to factory setting

1. Press the button  to start the process.
2. Press the button  until a corresponding confirmation is displayed on the HD monitor.

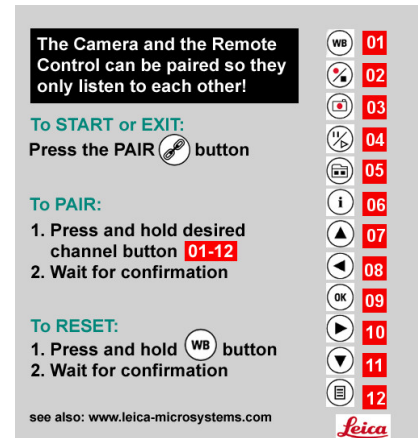

The Camera and the Remote Control can be paired so they only listen to each other!













To START or EXIT:
Press the PAIR  button

To PAIR:
1. Press and hold desired channel button **01-12**
2. Wait for confirmation

To RESET:
1. Press and hold  button
2. Wait for confirmation

see also: www.leica-microsystems.com



	01
	02
	03
	04
	05
	06
	07
	08
	09
	10
	11
	12

Application

Switching on the Leica MC170 HD or Leica MC190 HD (Standalone)

 Ensure that the optional objective is screwed onto the microscope, the mode switch is set to "HD" and the HD monitor is switched on.

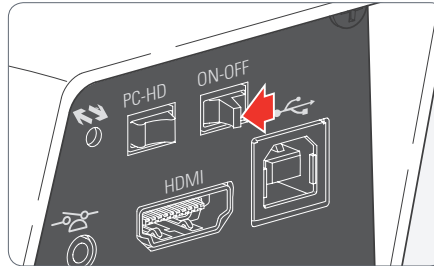

1. Set the on/off switch to "ON" to switch on the Leica MC170 HD or Leica MC190 HD.
2. The status light's LED switches from red to green, a signal tone sounds and the live image is displayed on the HD monitor - the Leica MC170 HD or Leica MC190 HD is ready to use.

Information About SD Memory Cards

General notes

 Be absolutely certain to read the following instructions about formatting and handling the memory card provided in order to prevent malfunctions during image acquisition.

File system and formatting

The FAT file system has to be used so that the SD card works correctly and is detected by the Leica MC170 HD or Leica MC190 HD. Most memory cards are factory-formatted with FAT so that they can be used immediately.

An SD card cannot be formatted in the Leica MC170 HD or Leica MC190 HD. If it is necessary to format the card, use a computer to do so. You can also delete the files on the card in any digital camera that works with SD cards. During the deletion, the FAT file system is installed automatically.

Write protection

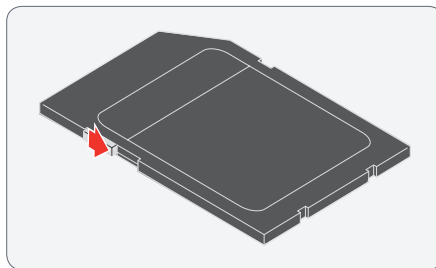

 Some SD memory cards are equipped with a slide for write protection. If the slide is pressed down, no new images can be saved. In addition, existing images are protected from being deleted.

If you cannot save any more images to the SD card, check to make certain that the write protection is disabled.

Orientation

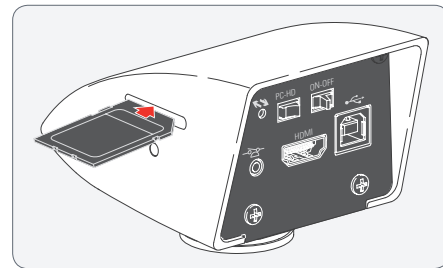

 Make sure that the memory card is oriented correctly before inserting it into the Leica MC170 HD or Leica MC190 HD. If you accidentally insert the card the wrong way around, this could damage the camera.

Capacity

Class 4 and 6 SD cards can be used with the Leica MC170 HD or Leica MC190 HD. SDHC (high capacity) cards up to 32 GB are also supported.

Capturing Images Without a Computer

General notes



Before capturing the image, ensure that enough memory is available on the SD card and that write protection has not been activated. If the SD memory card is full or protected, the Leica MC170 HD or Leica MC190 HD's status light stays red, and you cannot acquire any more images.



In order to avoid instrument malfunctions, do not connect the Leica MC170 HD or Leica MC190 HD to a computer while in HD mode (standalone).



In the highest resolution, a single image takes up approx. 1.3 megabytes of storage space on the SD card. This means that per gigabyte of capacity, you can save over 700 images.

Recording

1. Focus on the specimen.

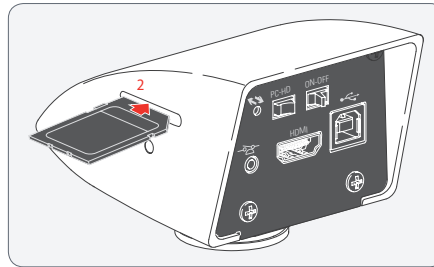

2. Push the SD memory card into the slot on top of the Leica MC170 HD or Leica MC190 HD until it clicks into place.

The Leica MC170 HD or Leica MC190 HD's status light is illuminated in green. The camera is now ready to save images to the SD memory card.

3. Press the record button on the remote control or press the (optional) handswitch/footswitch to capture an image.

You hear a signal tone as confirmation. While the image is being acquired, the status light flashes green and the word "Capture ..." appears briefly on the HD monitor.













4. In order to remove the SD card from the camera, press on the SD memory card in the memory slot so that it pops out.

You can now transfer the images to your computer directly using an SD card slot or by using an SD memory card reader.

Displaying Images and Videos Without a Computer

 The Leica MC170 HD or Leica MC190 HD can display images and video clips directly on an HD monitor.

Control via remote control:

1.  : Show/hide miniature view.
2.   : Select miniature image (JPG or MP4).
3. For a JPG image:
 -  : Display image in full size and zoomed in 1x, 2x, 3x (when pressing repeatedly).
 -   : Next/previous image.
3. For an MP4 video clip:
 -  : Play video.
 -  : Stop/play video.
 -   : Rewind/fast forward video.
4. In order to return to the live image, press the , , or  button – if you are in a zoomed-in image, you may need to do this more than once.

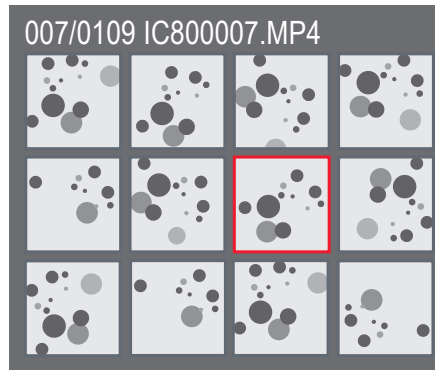

Thumbnail view

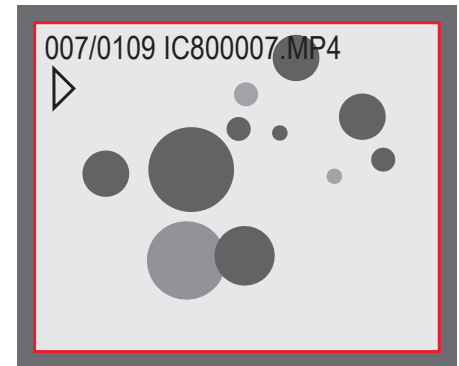

Reproduction / full screen

White Balance

General notes



The white balance ensures that the specimen is shown in neutral colors. We recommend carrying out a new white balance adjustment whenever you change the illumination type or color temperature. This is particularly necessary if you are working with halogen light that can be switched from yellow (low intensity) to blue (high intensity).



Configure the white balance via the user menu using the remote control. Depending on the configuration, automatic white balance can also be carried out using the foot-switch.



The white balance of the camera is factory set to automatically provide optimum results when used in conjunction with a Leica LED illuminator.

Manual white balance

- Manual white balance is described on [page 38](#).

Automatic white balance

1. Position a gray chart or a gray, neutral object under the microscope so that the entire image field is filled in.
2. Adjust the illumination as desired.
3. Press the button  on the remote control.

Switching on the Leica MC170 HD or Leica MC190 HD (PC Mode)

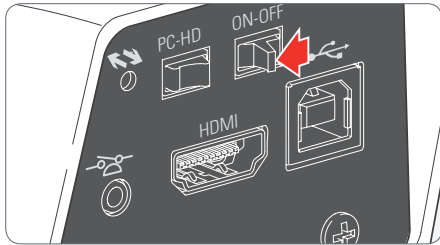

1. Set the on/off switch to "ON" to switch on the Leica MC170 HD or Leica MC190 HD.
2. Start Leica Application Suite.
3. The status light's LED switches from red to green, a signal tone sounds and the live image is displayed on the computer – the Leica MC170 HD or Leica MC190 HD camera is ready to use.
4. Follow the instructions in the software for adjusting and acquiring an image.

 For additional information on Leica Application Suite, please refer to "LAS Help".

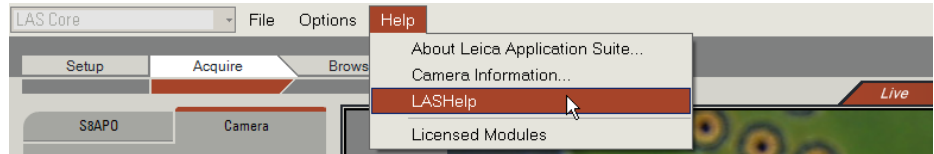

 You may be asked to specify your microscope's current instrument configuration when starting LAS for the first time. For the image source section, select the "Leica IC camera" or "Leica IC / MC camera" menu entry to select the Leica MC170 HD or Leica MC190 HD.

 If the Leica MC170 HD or Leica MC190 HD is connected to an HD monitor in PC mode:

- The remote control does not respond; in other words, the user menu does not appear.
- On the HD monitor, a live image is shown in 4:3 aspect ratio (with black bars on the right and left).

Additional Use of an HD Monitor (PC Mode)

General notes

 In PC mode, the microscope image is always shown in the preview window of Leica Application Suite. In addition, another HD monitor can be connected via the HDMI interface.

 The resolution on the connected HD monitor is limited by the live image resolution of the LAS software. Due to technical limitations, it is not possible to display a Full HD live image on the connected HD monitor. In order to do this, you have to switch the Leica MC170 HD or Leica MC190 HD to HD mode (standalone) ([see page 18](#)).

Connecting the HD monitor

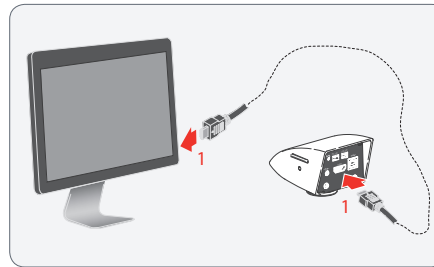



1. Connect the Leica MC170 HD or Leica MC190 HD to the HD monitor using the HDMI cable.

User Menu

Calling up the User Menu





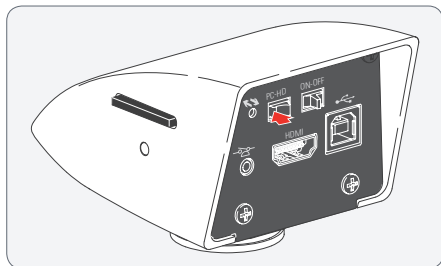

General notes

 The Leica MC170 HD or Leica MC190 HD is controlled entirely via the computer in PC mode. The remote control and the footswitch do not work. The menus for the camera are also not displayed on the HD monitor. Status information can be displayed on an HD monitor at any time despite this by using  on the remote control.



Calling up and closing the user menu

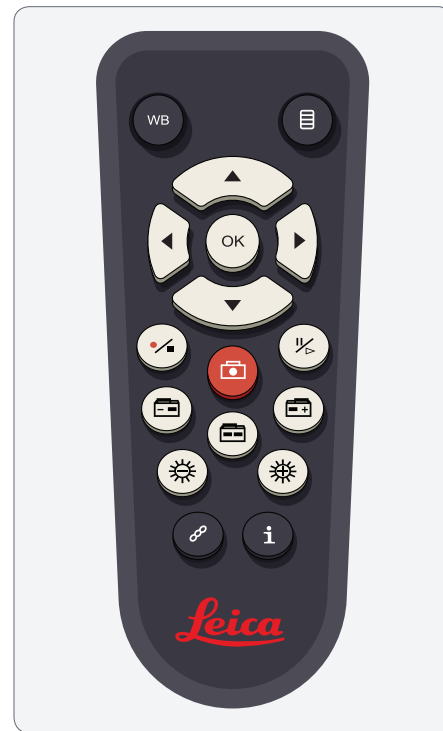

Check to ensure that the camera is in HD mode and that a live image is shown on a connected HD monitor.

1. Point the remote control towards the Leica MC170 HD or Leica MC190 HD.
2. Press the  button to show the user menu on the computer monitor.
3. Press the   /   buttons to select a menu item.
4. Press the  button to confirm a menu item.
5. Press the  button again to hide the user menu.



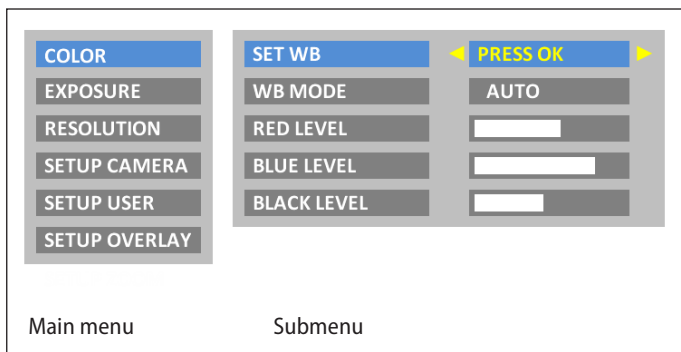

Automatic White Balance



-  The "COLOR" function makes it possible to adapt the camera chip to the ambient light so that color-neutral images can be acquired.
-  Whenever possible, use a neutral gray chart or another color-neutral object to attain optimum results.

Activating automatic white balance

1. Press the button  on the remote control.
2. Call up the "COLOR" entry.
3. Set the value for "WB MODE" to "AUTO".
4. Press the  button to leave the menu.

 The values for "RED LEVEL", "BLUE LEVEL" and "BLACK LEVEL" cannot be adjusted if the "WB MODE" setting is set to "AUTO".

 The color values are continually adjusted to achieve the most color-neutral picture possible if automatic white balance is enabled. This is often very bothersome for monochromatic specimens. In that case, enable manual white balance.

Manual White Balance

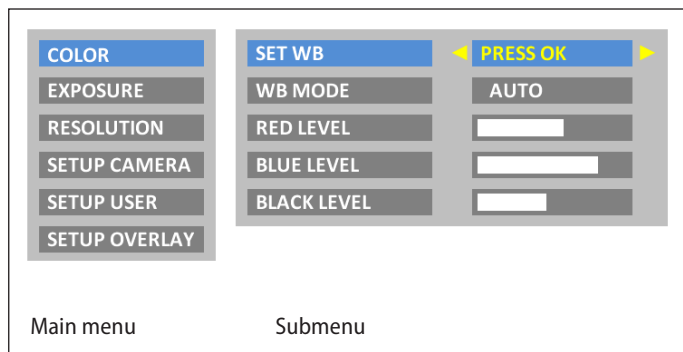



 The "COLOR" function makes it possible to adapt the camera chip to the ambient light so that color-neutral images can be acquired.

 Whenever possible, use a neutral gray chart or another color-neutral object to attain optimum results.

Adjusting the white balance manually (recommended)

1. Place the gray chart or another color-neutral object under the microscope so that the entire field of view is filled in.
2. Press the button  on the remote control. The white balance is calibrated and saved to the camera.

Alternatively, you can also calibrate the white balance using the user menu.

1. Press the button  on the remote control.
2. Call up the "COLOR" entry.
3. Select the "SET WB" menu item.
4. Press the  button.

 If you do not have a neutral gray area in the image or if the illumination has a very strong color cast, you can manually set the values for "RED LEVEL", "BLUE LEVEL" and "BLACK LEVEL" until the image displays a harmonious gray.

 The white balance mode is always set to "MANUAL" after manually adjusting the white balance, even if it was set to "AUTO" previously.

Exposure

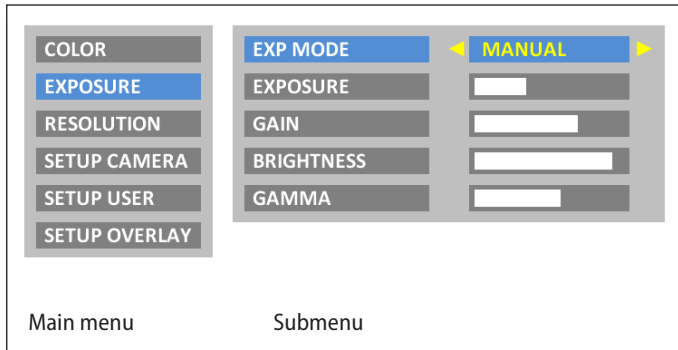

Manual exposure

1. Press the button  on the remote control.
2. Call up the "EXPOSURE" entry.
3. Set the value for "EXP MODE" to "MANUAL" for manual exposure.
4. Correct the values for "EXPOSURE", "GAIN" and "GAMMA" until you obtain the desired results for the image.

Automatic exposure

1. Press the button  on the remote control.
2. Call up the "EXPOSURE" entry.
3. Set the value for "EXP MODE" to "AUTO" for automatic exposure.
4. Correct the values for "BRIGHTNESS" and "GAMMA" until you obtain the desired results for the image.

Resolution

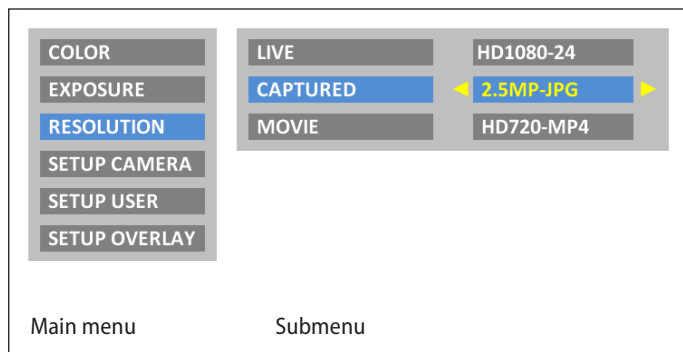

 The "RESOLUTION" menu lets you define the resolution individually for the live image on the computer, capturing individual images and capturing video.

Resolution of the live image (LIVE)

Defines the resolution of the live image. The following resolutions are available:

- HD720-50 and HD720-60: 1,280×720 pixels, at 50 Hz or 60 Hz image refresh rate
- HD1080-24 and HD1080-30: 1,920×1,080 pixels, at 25 Hz or 30 Hz image refresh rate, progressive
- HD1080-50 and HD1080-60: 1,920×1,080 pixels, at 50 Hz or 60 Hz image refresh rate, interlaced

Select a resolution that can be displayed on the HD monitor correctly without flickering and without an error message.

Resolution (Continued)

If a resolution cannot be displayed and the HD monitor remains black, you can do the following to display a live image again in the HD monitor:

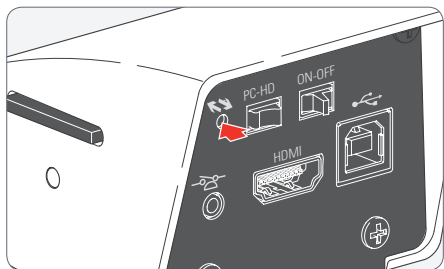

Use the tip of a ball-point pen (or a bent paperclip) to press the hidden button:

- Pressing the button for the first time displays the current live image resolution on the HD monitor.
- Pressing it a second time switches to the next live image resolution and a signal tone is output.
- Repeat the last step until a live image is displayed. The camera can activate 6 different resolutions in sequence.



A double signal tone is output when activating the recommended default resolution of HD1080-50.

Resolution of the captured image (CAPTURED)

Defines the resolution of the captured image saved directly to the SD card.

The following resolutions are available:

- 1.1 MP – JPG: 1,216×912 pixels
- 2.5 MP – JPG: 1,824×1,368 pixels
- 5 MP – JPG: 2,592×1,944 pixels
- 10 MP – JPG: 3,648 x 2,736 pixels (only available on the MC190 HD)

Resolution of videos (MOVIE)

Defines the resolution of video captures saved directly to the SD card. The following resolutions are available:

- HD720-MP4: 1,280×720 pixels
- HD1080-MP4: 1,920×1,080 pixels

About 50 MB of data are produced per minute with HD720 and 100 MB with HD1080 (slightly dependent on the contents and compression applied). A new file is created each time a file size of 1 GB is reached; capturing continues without interruption. Video capturing is discontinued if the SD card runs out of memory.

Camera Settings

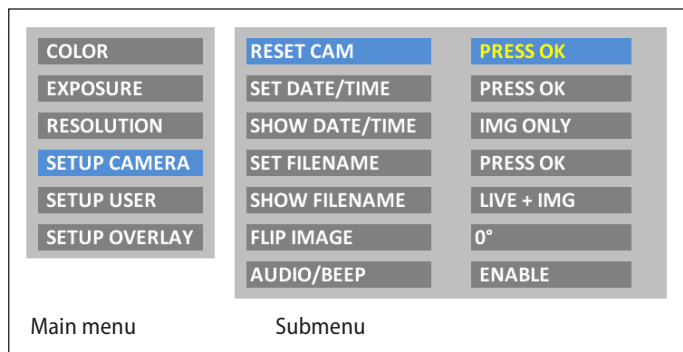

 The "SETUP CAMERA" menu lets you configure various internal parameters, such as the date and time, the file name for images on the SD card or whether a signal tone should sound each time an image is captured.

Reset camera (RESET CAM)

Resets the microscope to the factory default settings. All user information (such as white balance, resolution, etc.) is reset. Select this function if you are getting the impression the microscope is not responding normally or a setting has not been made correctly.

 Alternative method for resetting the camera: Use the tip of a ball-point pen (or a bent paperclip) to press the hidden button: Hold the button down for at least 5 seconds until a signal tone sounds.

Set the date and time (SET DATE/TIME)

This command sets the date and time as well as the format for displaying them. The following formatting options are available for selection: YYYY.MM.DD – DD.MM.YYYY – MM/DD/YYYY

Display the date and time (SHOW DATE/TIME)

Depending on the setting, this does not display the date and time at all, just displays it in the live image, just in image captures or in both the live image and image captures. The date and time are displayed or written into the top right corner of the image.

Set the filename (SET FILENAME)

Lets you freely select the first four characters of the filename for both single exposures and video recordings. By default, either MC17 or MC19 are used for the first four characters. These characters are followed by sequential numbering, followed by either JPG for individual images or MP4 for video recordings.

Camera Settings (Continued)

Display the filename (SHOW FILENAME)

Depending on the setting, this does not display the filename at all, just displays it in the live image, just in image captures or in both the live image and image captures. The filename is also shown or written into the top right corner of the image.



If you save the file name or the date and time into images, they cannot be deleted later, even if you rename the files or change the date.

Rotate image (FLIP IMAGE)

Allows you to flip the image along the horizontal and/or vertical axis.

Signal tone (AUDIO/BEEP)

Depending on the setting, you can have a brief signal tone sound after capturing an image. This can be helpful when working with a footswitch if you want to capture images without taking your eyes off the microscope.

Greyscale (only for MC190 HD)

Activates the greyscale mode of the camera. This removes the colour information and displays each pixel as greyscale only.

User-Defined Settings

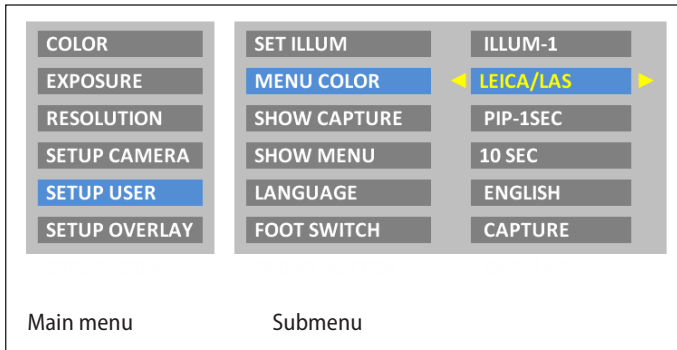



 The "SETUP USER" menu lets you change or switch certain user-specific settings to make working with the microscope a more enjoyable experience.

Set the illumination mode (SET ILLUM)

These settings allow you to define up to three different illumination modes, such as one for transmitted light or one for polarized light. This can save the current camera settings for recurring acquisition situations and retrieval again at any time.

Press ◀ ▶ to select illumination mode 1, 2 or 3. Press  to save the current camera settings under the displayed illumination mode.

 In order to select a pre-defined or newly defined illumination mode quickly without calling up the user menu, press in the live image  .

Set menu color (MENU COLOR)

Currently, two color schemes are available for the menu guidance. Additional colors may be provided in the future via a firmware update.

User-Defined Settings (Continued)

Show the capture (SHOW CAPTURE)

Lets you set whether or not a recently saved image is to be displayed in full screen or as picture-in-picture (PIP) on the monitor after capturing an image. You can also select whether the created capture is to be displayed for one second, three seconds or permanently (INFINITE).

Display the menu (SHOW MENU)

Defines how long the menu is displayed on the screen. You can stop the menu from being displayed at any time by pressing the menu button again or selecting a menu entry.

Set the language (LANGUAGE)

Lets you set the language for menu guidance. Select the fifth entry in the main menu if you have (unintentionally) selected an Asian language that uses logograms and want to return to a menu display that is alphanumeric. The menu entry for selecting the language is always added in English as well.

Configure the footswitch (FOOT SWITCH)

Lets the footswitch be configured with another function. By default, pressing the footswitch triggers image acquisition. However, you can choose if this should carry out a white balance adjustment, record a video or display the last capture instead.

Setting Image Overlays (SETUP OVERLAY)

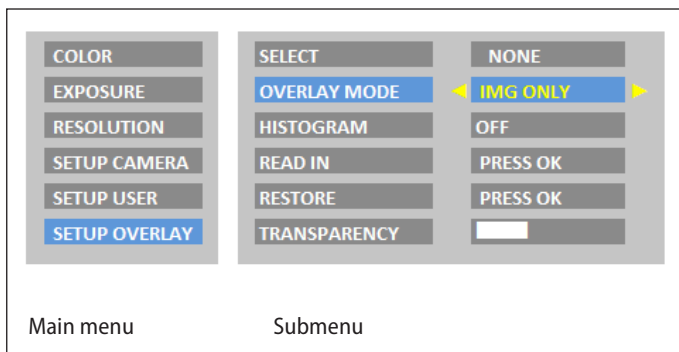

 The Leica MC170 HD or Leica MC190 HD lets you superimpose predefined or user-specific images in the live image and in captured images. These superimposed images (called overlays) can contain anything, but usually just contain a few elements such as a crosshair or company logo. Up to 10 overlays can be defined and can contain either predefined or user-specific content and let you configure your microscope for special tasks.

Selecting image overlays (SELECT)

Press ◀ ▶ to select another overlay. Press  to activate the selected overlay and leave the menu.

 If you want to quickly display other overlays, press when the live image is displayed ▼ ▲ to show the next or previous respective overlay.

Configuring image overlays (OVERLAY MODE)

Depending on the setting, this does not show an overlay, only shows the overlay in the live image or shows it in both the live image and the image capture.

HISTOGRAM

Lets you choose a histogram. The histogram can be shown in the live image or in the live and captures image. You can also deactivate the histogram.

Setting Image Overlays (Continued)

Importing image overlays (READ IN)

Imports up to 10 user-specific overlays from the SD card from the "Overlay" directory. The overlays need to be saved as a JPG with 4:2:2 compression and must have both the appropriate resolution and a specifically defined filename. Various overlays are available for download on the Leica Microsystems website, as well as a manual for how to create your own overlays, in the download area for this camera. Follow those instructions to create new overlays.

Restoring image overlays (RESTORE)

Resets the overlays to the factory setting: A Leica logo, a crosshair over the entire live image and a small crosshair in the middle of the live image.

Set transparency (TRANSPARENCY)

The overlay's edges are more or less prominent depending on the selected setting.



This setting does not change the transparency of the overlay.

Configuring Predefined Illumination Scenarios

Changing the illumination mode

 The Leica MC170 HD or Leica MC190 HD is supplied with various illumination modes that cover a wide spectrum of possible situations.

1. Press ◀ ▶ on the remote control to display the current illumination mode on the HD monitor.
2. Press ◀ ▶ again to switch to the next illumination mode. The microscope immediately switches the illumination mode and sets the stored parameters.
3. Wait until the displayed illumination mode disappears from the monitor. This means that illumination mode is now active.

 To return to the last selected mode, press ◀ ▶ until the "LAST USED" setting appears.

 If you do not press ◀ ▶ for 5 seconds, the selected illumination mode is applied.

Sequence



Service

Care, Maintenance, Contact Persons

General

We hope you enjoy using your high-performance camera. Leica microscope cameras are renowned for their robustness and long service life. Observing the following care and cleaning tips will ensure that even after years and decades, your Leica camera will continue to work as well as it did on the very first day.

Warranty benefits

The guarantee covers all faults in materials and manufacture. It does not, however, cover damage resulting from careless or improper handling.

Contact address

If your instrument no longer works perfectly, contact your Leica representative. You can find information on worldwide Leica representatives on the Leica website: www.leica-microsystems.com.

Care, Maintenance, Contact Persons (Continued)

Care

- Keeping all optical components clean is important for maintaining good optical performance.
- If any optical surface becomes badly coated with dust or dirt brush it off with a camel hair brush before attempting to wipe it clean.
- Optical surfaces should be cleaned using a lint-free cloth, lens cloth or cotton swab soaked in methanol or a commercially available glass cleaner. Do not use alcohol.
- Avoid excessive use of solvents. The lint-free cloth, lens cloth or cotton swab should only be lightly moistened with solvent.
- Protect your microscope camera from moisture, fumes and acids and from alkaline, caustic and corrosive materials and keep chemicals away from the instruments.
- Plugs, optical systems and mechanical parts must not be disassembled or replaced, unless doing so is specifically permitted and described in this manual.
- Protect your microscope camera from oil and grease.
- Do not grease guide surfaces or mechanical parts.

Protection from dirt

Dust and dirt will affect the quality of your results.

- Put an optionally available dust cover over the microscope camera when it will not be used for a long time.
- Keep accessories in a dust-free place when not in use.

Care, Maintenance, Contact Persons (Continued)

Cleaning polymer components

Some components are made of polymer or are polymer-coated. They are, therefore, pleasant and convenient to handle. The use of unsuitable cleaning agents and techniques can damage polymers.

Permitted measures

- Remove dust on the filter glass with a bellows and a soft paintbrush.
- Your local Leica Service or an appropriately trained user can replace a dirty or scratched glass filter in front of the camera sensor.
- Changing the filter requires a suitable tool (article number 12 730 487) and replacement filter (article number 12 730 484).
- Please contact Leica Service for these service parts and corresponding instructions.
- Clean the objectives with special optics cleaning cloths and pure alcohol.

Servicing

- Repairs may only be carried out by Leica Microsystems-trained service technicians. Only original Leica Microsystems spare parts may be used.

Spare Parts



Item	Leica article number	Designation
1	19 004 872	HDMI cable (2 m)
2	19 004 871	USB cable (1.8 m)
3	13 302 708 946 915	5 W USB adapter with interchangeable connector
4	10 450 805	IR remote control RC3
5	19 004 870	SD card (4 GB)
6	12 730 229	Footswitch

Specifications

Leica MC170 HD or Leica MC190 HD

Leica MC170 HD or Leica MC190 HD digital camera

- Weight 250 g (camera only)
- Exposure time 0.5 msec. – 500 msec.
- Live image on an HDMI monitor at up to 30 fps (1,280 x 760 pixels)
Live image on an HDMI monitor at up to 30 fps (1,920 x 1,080 pixels)
- Full-screen image capture at 5 megapixels (MC170 HD) or 10 megapixels (MC190 HD)
- Sensor size: 6.1 mm × 4.6 mm
- Pixel size (at max. resolution): 2.35 µm × 2.35 µm (MC170 HD)
- Pixel size (at max. resolution): 1.67 µm × 1.67 µm (MC190 HD)

Sensor grade

- Sensor grade: Aptina 1/2.3" CMOS
- Gain 1× – 12×
- Color depth 24-bit
- File formats: JPG / TIF / AVI (PC), JPEG / MP4 (HD)

Software

Operating systems: Windows XP, Windows 7, Mac OS X

Leica software: LAS and LAS EZ software (PC), Acquire software (Mac)

Mechanical and optical interfaces

- Mechanical: C-mount thread
- Color filter: Type IRB680, replaceable, (stock number: 12 730 484)
- Recommended C-mount adapter: 0.55× / 0.5×

Electronic interfaces

- Compatibility: USB 2.0, standard USB plug type B
- High-definition connector: HDMI 1.3, standard HDMI plug type A
- Audio signals for recording, white balance, etc. (can be turned off)
- On/Off switch, PC/HD switch: Available, on rear side of the camera
- Pinhole switch for selecting a different HD resolution
- RC3 infrared remote control, with 2× AAA batteries
- Hand and foot trigger, with 1.5 m cable
- 3-color LED for power on (green) / busy (yellow) / error (red)
- Integrated SD slot (Secure Digital)
- Reset function when pinhole switch is pressed longer than 5 seconds
- Firmware update function when pinhole switch is pressed longer than 10 seconds

Leica MC170 HD or Leica MC190 HD (Continued)

Power supply voltage and frequency

- Input: 100–240 V, 200 mA
- Output: 5 V, max. 1 A
- Input power 10 W
- Power consumption 4 W

Miscellaneous

- Power supplied via USB cable to computer or to external 5 V USB power supply unit
- Operating temperature range +5 °C – 50 °C, humidity 10% – 90 %
- Minimal computer configuration:
PC/Mac, Intel Core 2 Duo,
>2.4 GHz, 4 GB RAM, 24-bit graphics
- CE Declaration of Conformity available

Norms

- EMI/RFI: EN55011-B; EN50082-1
- EMC: 61000-3-2; 61000-3-3

Dimensional Drawings

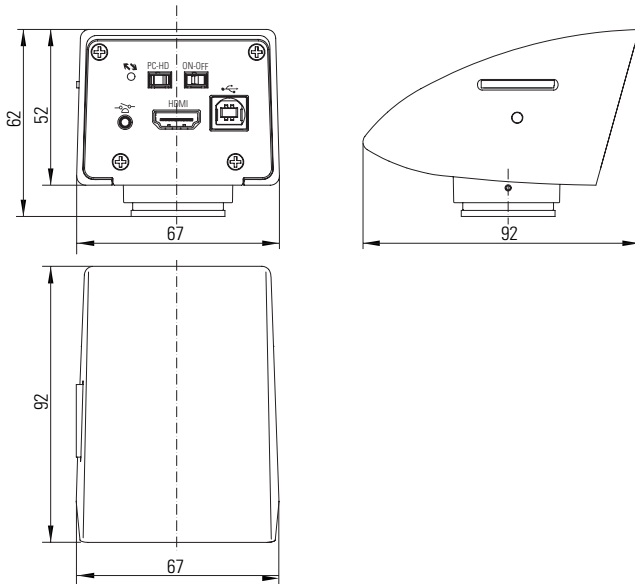



Leica Microsystems (Schweiz) AG · Max-Schmidheiny-Strasse 201 · 9435 Heerbrugg, Switzerland
T +41 71 726 34 34 · F +41 71 726 34 44

www.leica-microsystems.com

CONNECT
WITH US!

