



## Contents

<b>01</b>	<b>About ICC-----</b>	<b>1-2</b>
<b>02</b>	<b>ICC optical materials-----</b>	<b>3-5</b>
<b>03</b>	<b>ICC optical window and prism-----</b>	<b>6-8</b>
<b>04</b>	<b>ICC precision lens fabrication-----</b>	<b>9-10</b>
<b>05</b>	<b>ICC optical coating-----</b>	<b>11-12</b>
<b>06</b>	<b>How to make qualified silicon lens-----</b>	<b>13-14</b>
<b>07</b>	<b>ICC optical components supermarket-----</b>	<b>15-19</b>
<b>08</b>	<b>Contact information-----</b>	<b>20</b>



# About ICC

ICC Fabrication, data speaking!

本征晶体  
Intrinsic Crystal

## Qinhuangdao Intrinsic Crystal Technology Co., Ltd. (ICC)

No.1 Xihu Road, Economic Tech Zone, Qinhuangdao City, Hebei Province, 066000, China

Http://www.intrinsiccrystal.com Http://www.bz-optical.com Http://www.caf2.com.cn

Complaints: Tom Li (VP of marketing) Tel: +86 335 752181 Fax: +86 335 7526184

Email: postmaster@intrinsiccrystal.com

### ICC Core Competitive Products:

- A. Optical fluoride crystal materials-CaF<sub>2</sub>/BaF<sub>2</sub>/MgF<sub>2</sub>/LiF
- B. Massive precision optical components fabrication-Plate/Lens/Wedge
- C. Optical coating-Laser and IR coating

### Organizational structure:

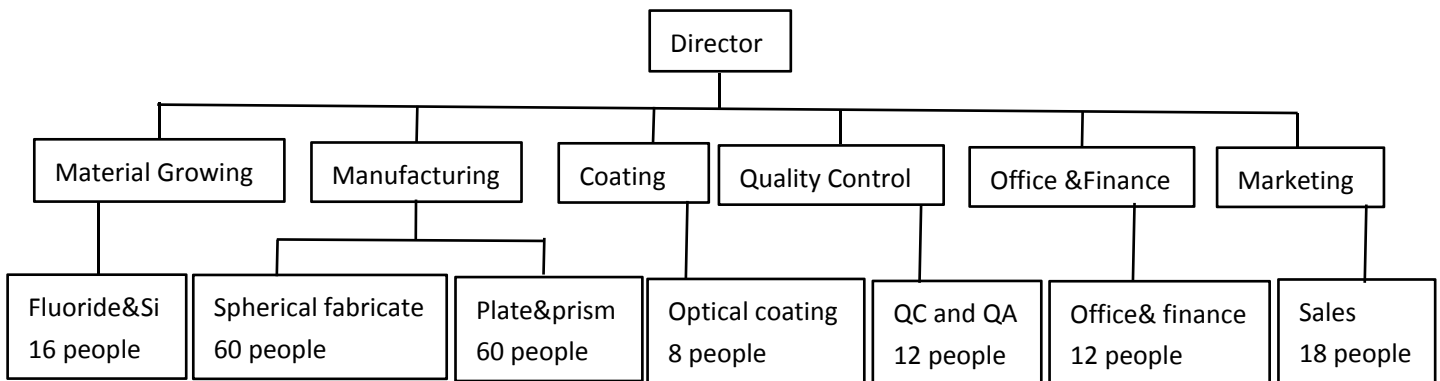

### Company Certificates:

DUNS NO.:53-098-3523, SGS, ISO9001-2005,ISO14001-2005,OHSAS18001-2007

**DUNS Registered™ Supplier Capability Evaluation (Manufacturing)**  
Qinhuangdao Intrinsic Crystal Technology Co., Ltd.  
D-U-N-S®: 53-098-3523

**SGS**  
Report Number: QIP-ASI166146  
Audit Date : 08 Jul., 2016

**Made-in-China.com™**  
Connecting Buyers with Chinese Suppliers

**Certificate of Registration**  
nqa  
This is to certify that the Quality Management System of Qinhuangdao Intrinsic Crystal Technology Co., Ltd. has been assessed and registered by NQA against the provisions of ISO 9001:2005.

Certificate Number: 40991  
Date: 08 June 2015  
Review Date: 07 August 2018  
Valid Until: 07 June 2021  
EAC Code: 11

**Certificate of Registration**  
nqa  
This is to certify that the Occupational Health and Safety Management System of Qinhuangdao Intrinsic Crystal Technology Co., Ltd. has been assessed and registered by NQA against the provisions of OHSAS 18001:2007.

Certificate Number: 82560  
Date: 31 April 2017  
Review Date: 07 August 2018  
Valid Until: 29 April 2020  
EAC Code: 11

**Certificate of Registration**  
nqa  
This is to certify that the Environmental Management System of Qinhuangdao Intrinsic Crystal Technology Co., Ltd. has been assessed and registered by NQA against the provisions of ISO 14001:2005.

Certificate Number: 43363  
Date: 21 April 2017  
Review Date: 07 August 2018  
Valid Until: 07 August 2021  
EAC Code: 11



**MSDS**  
Material Safety Data Sheet

## 1. Business target and operational conception:

### Direction and goal:

offer the best service of infrared optical material growing and high precision optical components.

### Operational conception:

Competitive&data supported products, transparent process control, effective&timely service.

**Factory fundamental:** improve fine technique, stable massive production

## 2. Company history:



2002-2006, domestic sale for fused silica special glass and optical coating materials

2006-2010, establish infrared crystal material growing line and optical components production workshops

2010-2018, complete infrared crystal material R&D-growing-cutting-polishing-coating processes

2018-2021, create infrared optical products and services at home and abroad cost-effective advantages, and launch the company's prototype products

## 3. Business status:

**Industry involved:** Instrument-optical instrument-optical material and components

**Sales value:** RMB 50million of year 2017, RMB60 million of year 2018

**Customer group:** 40% domestic, 60% exported to USA/Europe/UK/Japan/Korea/Middle east etc, over 30 countries

**Products application:** Optical instruments and spectral analysis-20%; Infrared and electronics-40% ; Environmental and medical treatment-20%; Laser industry-15%; Others-5%

## 4. Company commercial items:

**Payment acceptable:** Cash, Paypal, T/T

**Payment term:** 50% prepaid for new customer, net 30-90 days for old customers.

**Quality dispute clause:** quality control document shipped together with goods, customer needs supply quality test report once abnormal happened.

**Competitiveness control clause:** given yearly 1-5% discount within 3 years for massive repeated order.

**Regulation clause:** Sign NDA, confidentiality agreement, mineral conflict agreement, ROHS agreement etc





ICC is the top leading optical fluoride crystal material and single crystalline silicon grower in China since 2008. Those materials include CaF<sub>2</sub>, BaF<sub>2</sub>, MgF<sub>2</sub>, LiF and silicon, all ourself growing.

- ◆ CaF<sub>2</sub>
- ◆ BaF<sub>2</sub>
- ◆ MgF<sub>2</sub>
- ◆ LiF
- ◆ Si

### Description

#### 1) Specifications:

**CaF<sub>2</sub>:** VUV-193/248nm, UV-305nm, VIS-IR-700-10.0um, orientation <111> <110> <100>, size D3-200mm

**BaF<sub>2</sub>:** UV, IR grade, orientation <111> <100>, size D3-140mm

**MgF<sub>2</sub>:** VUV-121/157/193/248nm, UV,IR grade, orientation <001><100>, size D3-150mm

**LiF:** EUV,UV grade,orientation<100>, D3-150mm

**Si :** Optical, mirror and semiconductor grade; <111>, <100>, <110>, size D3-350mm

**Crystalline:** single and poly

**Type:** rods,blanks,disks

**Shape:** round,square,drilled,step,wedge,plate,prism,lens,etc

**2)Growing method:**Bridge-man method, Czochralski technique

**3)Capacity:** top leading optical fluoride crystal grower in China

**4)Application:**

Optical components production companies, serves for laser,optical,UV/IR,FTIR spectral,medical,semiconductor,thermal and aerospace industries well.

### Optical fluoride crystal production process:

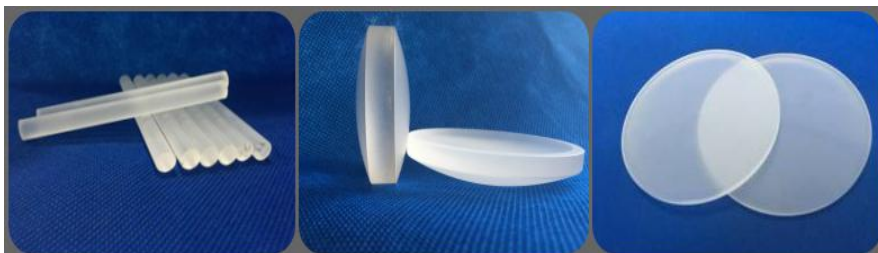
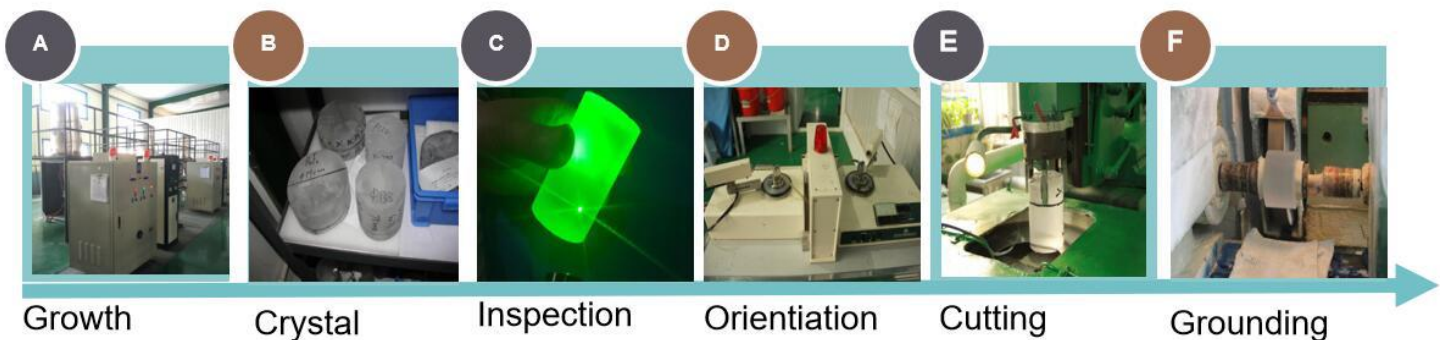

**MSDS**  
Material Safety Data Sheet





Items	CaF2	BaF2	MgF2	LIF
Density	3.18g/cm3	4.89g/cm3	3.18g/cm3	2.64g/cm3
Solubility	0.0017g/100g water at 20°C	0.0017g/100g water at 20°C	0.0002g/100g water at 20°C	0.27g / 100g water at 20°C
Transmission Range	130nm-10um	150nm-14um	110nm-7.5um	0.18-8.5um
Transmittance	>94%@193nm-7.87um	>94%@350nm-10.8um	>90%@193nm-6um	
Refractive Index	1.39908@5um	1.462@2.58um; 1.396@10.35um	NO=0.37608; NE=1.38771@0.7um	1.38711@1um
Reflection Loss	5.4%-5um(both surfaces)	6.8%@2.58um; @10.35um	5.2%@0.6um(both sides)	5.2% at 0.6 μm (2 Surfaces)
Absorption Coefficient	0.03cm-1@2.6um-2.9um	20.6mm	20nm	5.9 x 10-3 cm-1 at 4.3 μm @ 300K (5)

**Different wavelength transmission curve compare:(100-200nm, 200-3000nm, 1500-21500nm)**

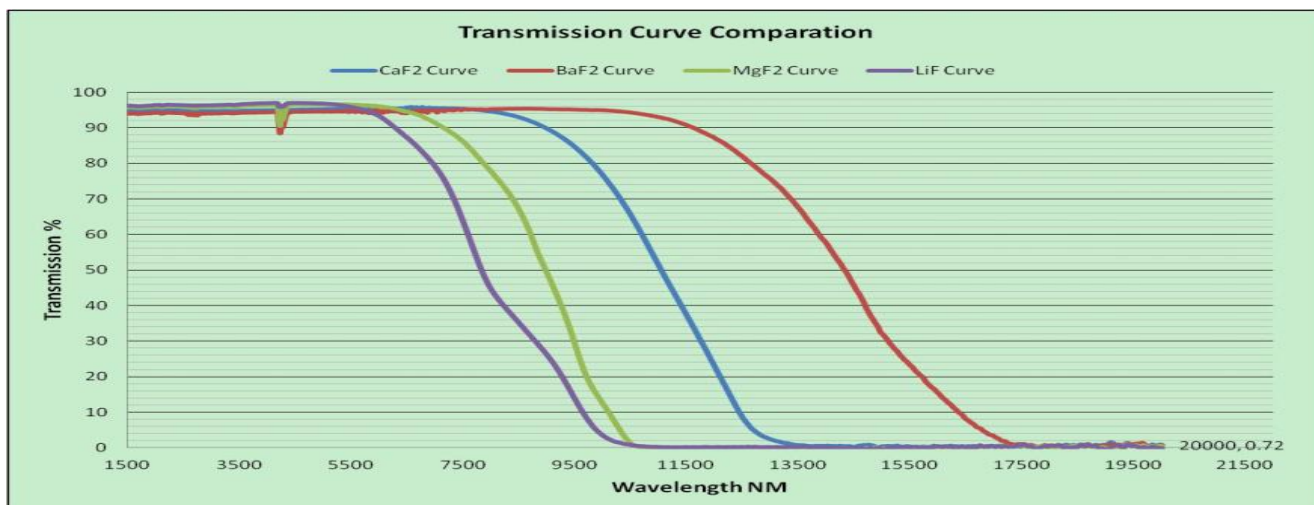
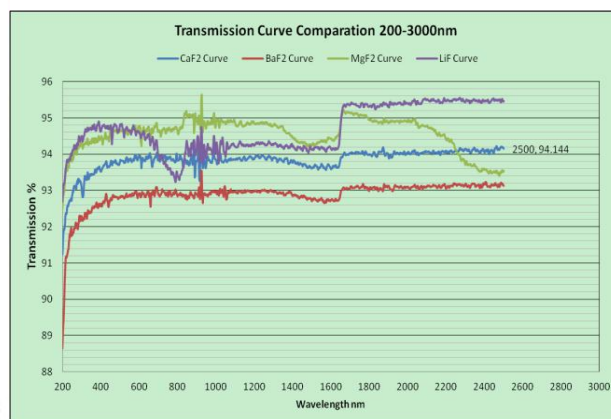
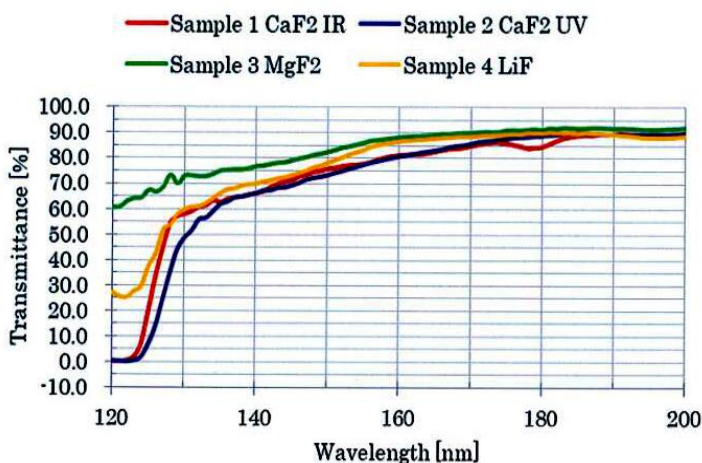



### 1. Single and poly crystalline

Single crystal is one crystal nucleus, polycrystal more than one. The transmittance and purity of single crystal and polycrystal are the same, and there will be differences in uniformity, but not in mechanical properties.

### 2. Single crystalline and Orientation

The required orientation material must be single crystal; Conversely, the single crystal must have a direction, but due to the different growth methods, our quotation is just the single crystal random orientation. In terms of material performance and price, orientation is better than single crystal and polycrystal. ICC directional ability may reach +/- 10 minute.

### 3. EUV, UV, IR and Roman grade

Excimer grade 151-258NM, VUV < 200NM, UV 200-400NM, IR 400-8000NM, Raman grade lower transmission requirement but need no fluorescence.

1. CaF2 poly material blank

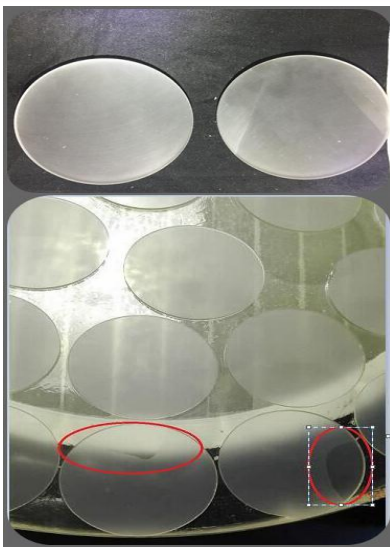

2. MgF2 poly material by polarizing interferometer

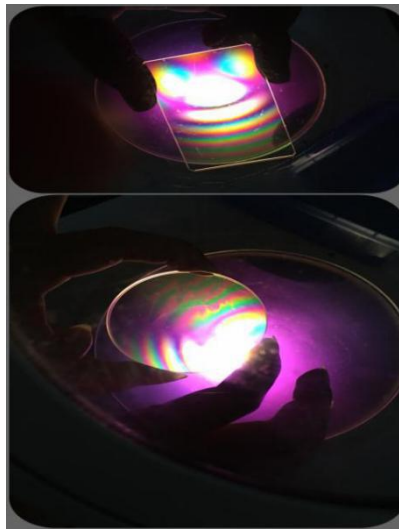

3. MgF2 mono material by polarizing interferometer

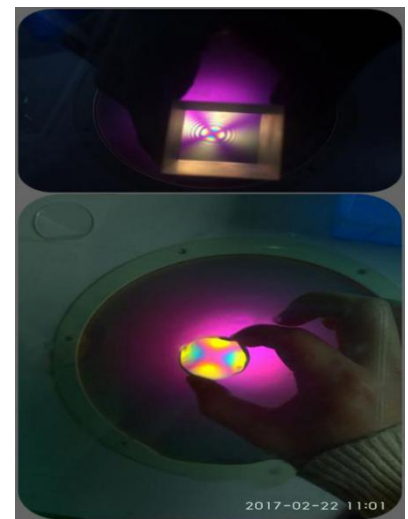

4. LiF material poly/mono x-ray curve

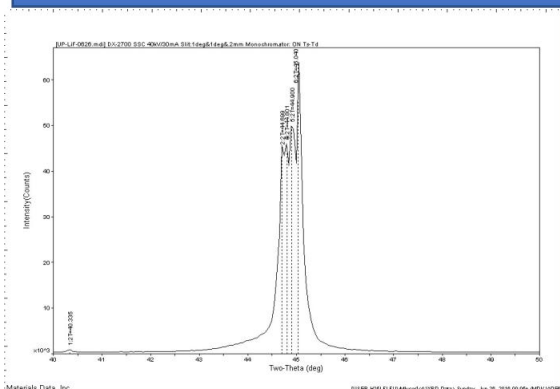

5. CaF2 Mono material by ZYGO

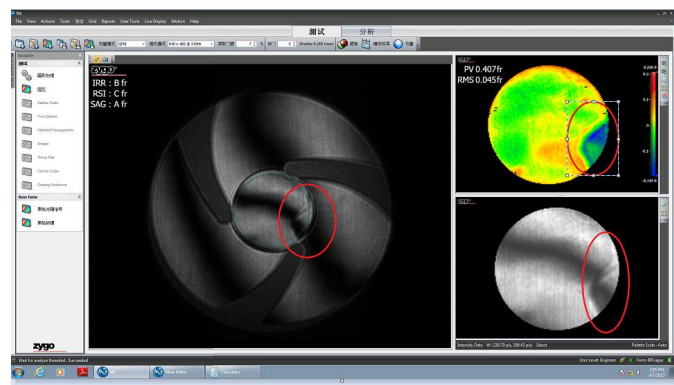



# Silicon Material Datasheet

**ICC Fabrication, data speaking!** 本征晶体  
Intrinsic Crystal

ICC is a large silicon material grower in China, we use purity 99.9999999% Germany imported raw material for crystal growing. Hence supply material blanks, as cut, lapped and 2" to 8" wafers. Include optical, mirror and semiconductor grade silicon material.

Structure: Mono crystalline  
 Growing method: CZ/FZ  
 Type: N/P  
 Orientation: <111> <100> <110>  
 Resistivity: 0.005-10kohm.cm  
 Grade: Optical/Mirror/Semiconductor/Target  
 Dislocation density: None  
 Density: 2.33g/cm<sup>3</sup>  
 Melting Point : 1414°C  
 Transmission range: 1.2-15um



Optical application: band pass filter, thermography, ATR crystal, mirrors, wafer, windows, lenses, band pass filter, ATR crystals, etc.

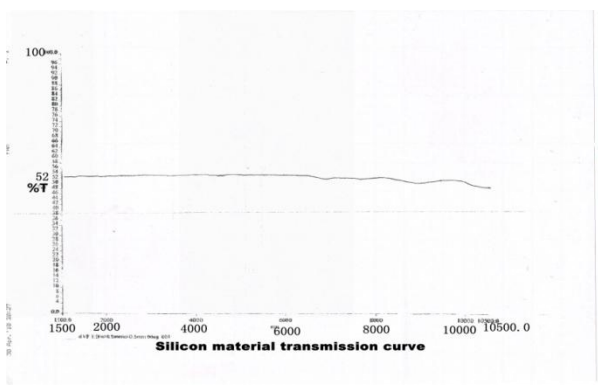

<b>Physical properties</b>		Bulk Modulus	101.97 Gpa
Density	2.33g/cm <sup>3</sup>	Dielectric constant	13@f=9.37GHz
Hardness, Mohs	7	<b>Chemical properties</b>	
Dielectric Constant for 9.37 x 10 <sup>9</sup> Hz	13	Solubility in water	None
Melting point °C	1414	Molecular Weight	28.09
Thermal Conductivity	W/m·K at 313 K163	<b>Optical properties</b>	
Thermal Expansion	1/K at 293 K2.6x10 <sup>-6</sup>	Crystal type	Cubic, NaCl type structure
Specific Heat Capacity	J(kg·°C)712.8	Crystal structure	Single crystal, synthetic
Bandgap	eV1.1	Cleavage planes	<111>
Knoop Hardness,	kg/mm <sup>2</sup> 1100	Transmission range	1.2-15um;
Young's Modulus	130.91 Gpa	Refractive index	3.41776@10um
Shear Modulus	79.92 Gpa	Reflective loss	46.1%@10um
Rupture modulus	125 MPa	Optical application	plate/lens/mirro/filter/mirror





# ICC Optical window and prism

**ICC Fabrication, data speaking!** 本征晶体  
Intrinsic Crystal

## Process steps

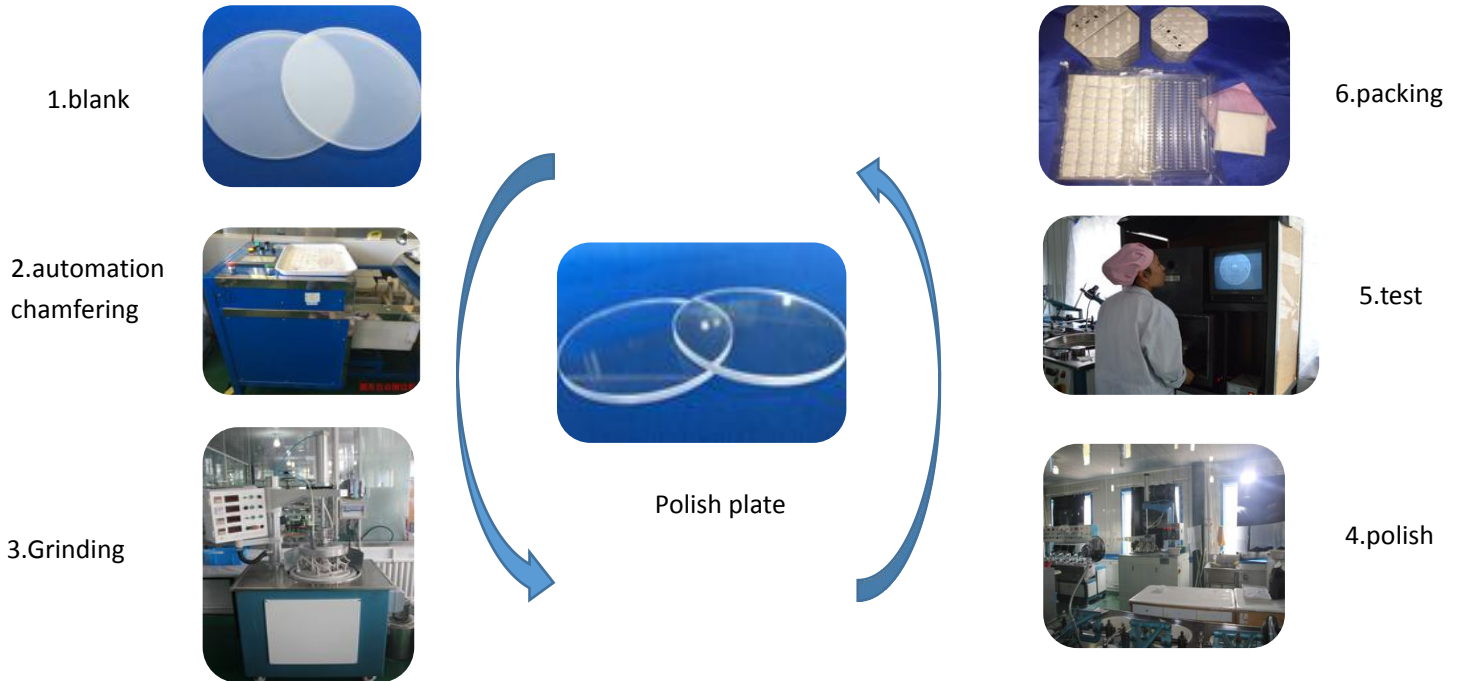

## Test tools:

Items	Inspection tools	Q.C file
Size&tolerance	digital display micrometer&non-contact laser	material datasheet, Rohs,COC,COT, coating witness, coating curve
Radius	spetrometer	
S/D	Naked eyes under 20w white light	
Surface roughness	Atomic force microscope	
Flatness	Zygo&fuji interferometer	
Wedge&angle	5 second goniometer	
Parallelism	Digital display micrometer&parallelism tube	
Chip&bevel	Projector and microscope	
Coating	UV-VIS&IR spectrophotometer	

## Polish machines:







ICC factory plate Process ability:

Material	Diameter	S/D	Clear aperture	PV	Parallelism
CaF2	0-15	40-20	>90%	0.25-0.5	0.01-0.02mm
	15-30	40-20	>90%	0.25-0.5	0.01mm
	30-50	40-20	>90%	0.5-1	0.01mm
MgF2	50-100	60-40	>90%	1-1.5	0.01mm
	>100	60-40	>90%	1-1.5	0.01mm
BaF2	0-15	40-20	>90%	0.5-1	0.01-0.02mm
	15-30	40-20	>90%	0.5-1	0.01mm
	30-50	40-20	>90%	1-2	0.01mm
	50-100	60-40	>90%	1-2	0.01mm
	>100	60-40	>90%	1-2	0.01mm
Ge	0-15	60-40	>90%	<1	0.01-0.02mm
	15-30	60-40	>90%	<1	0.01mm
	30-50	60-40	>90%	1-2	0.01mm
	50-100	80-50	>90%	1-2	0.01mm
	>100	80-50	>90%	1-2	0.01mm
Si	0-15	60-40	>90%	0.25-0.5	0.01-0.02mm
	15-30	60-40	>90%	0.25-0.5	0.01mm
	30-50	60-40	>90%	0.5-1	0.01mm
	50-100	80-50	>90%	1-2	0.01mm
	>100	80-50	>90%	1-2	0.01mm
UVFS	0-15	40-20	>90%	1/10L	5"-10"
	15-30	40-20	>90%	1/10L	5"-10"
	30-50	40-20	>90%	1/10L	5"-10"
	50-100	40-20	>90%	1/10L	5"-10"
	>100	40-20	>90%	1/10L	5"-10"

customized: circular, square, perforated, step, special-shaped sheets

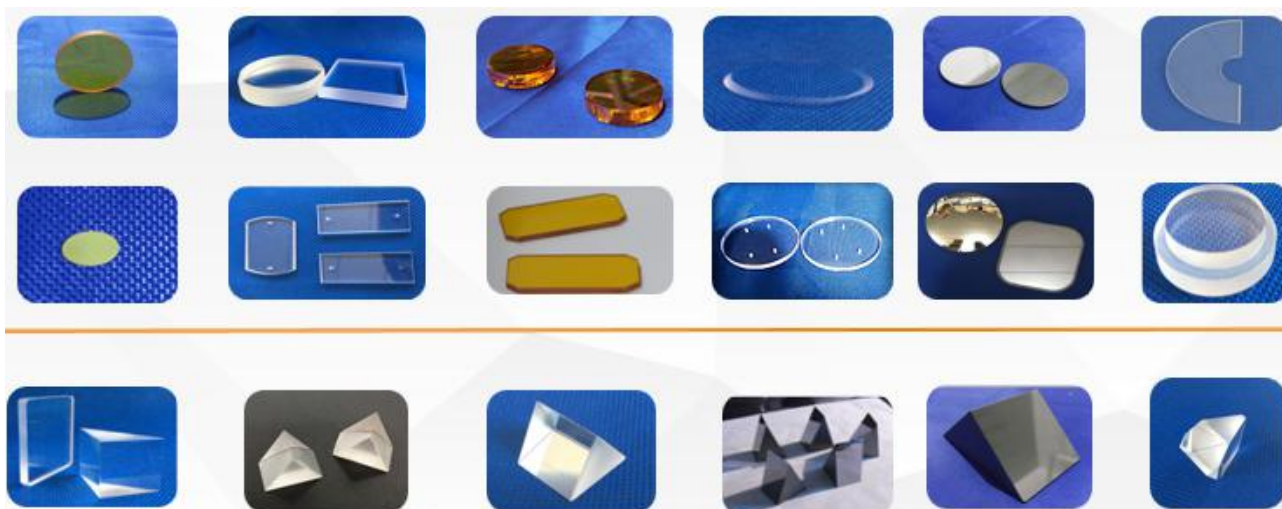



## Precision Lens Fabrication is one of ICC's Core Business

**Workers:** 60 workers engaged in Spherical and Cylindrical Lens

**Procedure:** Overlay template and tooling production-milling, polishing and centering

**Machines:** 50 sets classical and high speed polishing machine, 6 Sets interferometer in process and final Inspection

**Ability:** 5000 sets/Month for D38.1mm Infrared Lens

**Species:** Single Len, Double Lens, Cylindrical Lens

### Advantages in Lens

Widely used in SWIR/MWIR/LWIR camera, supply SI/GE/ZNSE/ZNS/Fluoride Lenses

Fluoride and silicon lens: self-long material, self-processing, self-coating, whole chain cost performance

Common Dimension Lens: D80-300mm

Items	Spherical	Cylindrical	Doublet
Material	Optical glasses from Schott, Ohara, Corning, CDGM (main) Crystal: CaF <sub>2</sub> , BaF <sub>2</sub> , MgF <sub>2</sub> , LiF, Si, Ge, ZnS, ZnSe		
Size & Tol (mm)	3.0-297+/-0.025	2-350+/-0.05	3-150+/-0.05
Thk & Tol (mm)	0.5-50+/-0.05	1-70+/-0.05	3-100+/-0.05
Bevel & Tol (mm)	0.25+/-0.1	0.25+/-0.1	0.25+/-0.1
S/D	20-10	20-10	40-20
Irregular Power	1/10L@632.8nm	1/10L@632.8nm	1/4L@632.8nm
Center	0.5 arc min	1 arc min	1 arc min
Coating	Anti-reflective: MgF <sub>2</sub> , SiO <sub>2</sub> , BBAR, DLC, V-coating, Reflective: Al, Ag, Au, Dielectric Beamsplitter: P/S 50:50; 47:53;		

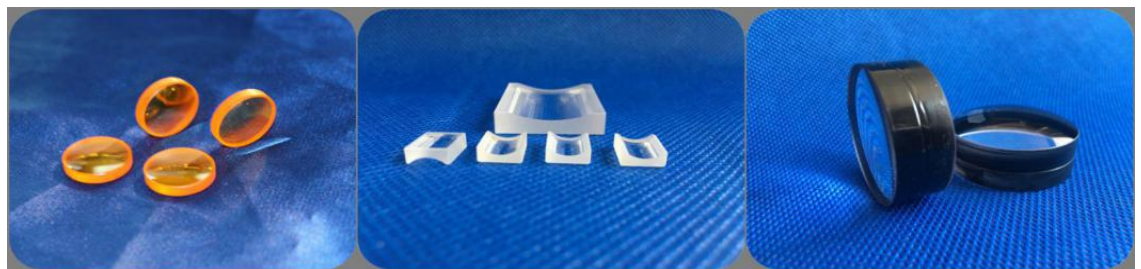
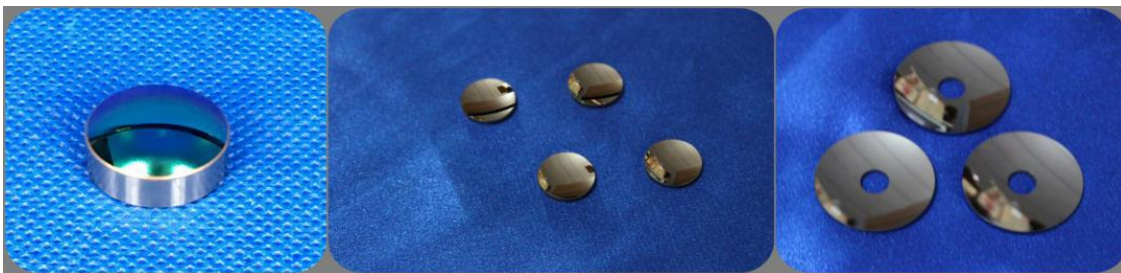



## Precision Lens Production Process



**Maximum opening diameter up to 300mm**

Owens 6 sets milling machines , can provide the D300mm lens, and process infrared material and optical glass



**Template Accuracy customized mould**

Supply customized template and mould, have A large number of model libraries and 2sets CNC



**Polishing Machine, High Efficiency**

10 sets High Speed Polishing Machines and more than 30 Single Axis/Four Axis/Six Axis Polishing Machines



**Strict quality control process, high quality**

Owens advanced testing equipment, strictly inspected before shipment, and QA departments

## Precision Lens Production Process

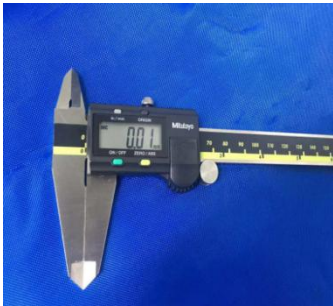

**Test size**

Japanese Mitutoyo Micrometer and Digital Caliper to ensure the accuracy of physical dimension



**Test S/D**

Infrared Microscope and Atomic Force Microscope Guarantee Surface Quality to Customized Standards



**Test flatness**

Zygo, Fuji interferometer provides detailed surface detection report Spherical caliper, Zygo guide

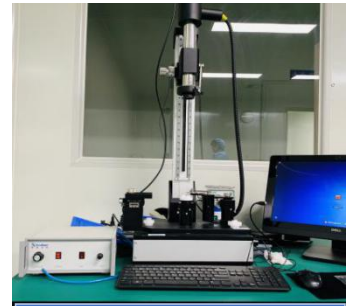

**Test centerarteion**

Mechanical Centering and Optical Centering Accuracy can reach 1% Domestic Eccentricity





Coating is an important part of ICC whole optical processing chain. Coating Center, with experienced technical team, good production environment, advanced optical coating equipment and testing equipment! Optical coating products cover near ultraviolet, visible light, near infrared, far infrared band, Major in laser, infrared optics, traditional optics. The products can be customized according to the specific requirements.

## Classification of coating

- |                           |                                      |
|---------------------------|--------------------------------------|
| 1 Anti-reflective coating | 6 Polarizing spectroscopic coating   |
| 2 Reflectance coating     | 7 Laser crystal coating              |
| 3 Infrared coating        | 8 Fiber coating                      |
| 4 Ultraviolet Coating     | 9 Metal anti-reflection coating      |
| 5 Interference filter     | 10 DLC( diamond like carbon coating) |

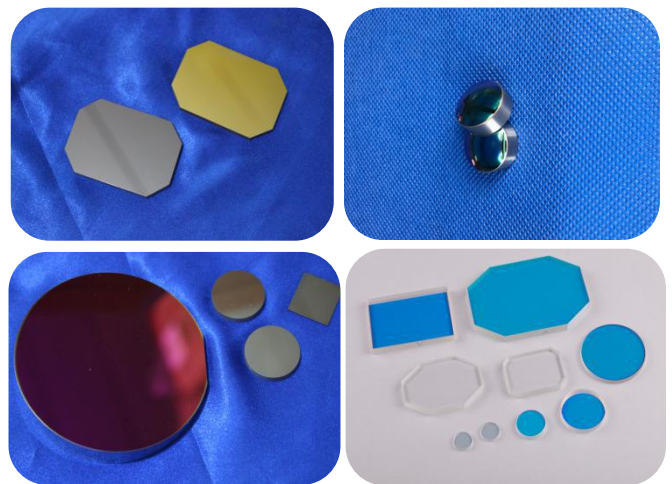

**Testing equipment**  
Spectrophotometer  
Covering 0.2-25um



**Engineer**  
8 people IBS assisted



**Coating equipment**  
6 sets

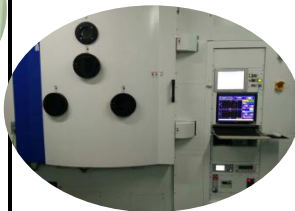

**Ultrasonic cleaning equipment**  
2 sets



**Ultra-clean table**







# ICC Optical Coating Curve

ICC Fabrication, data speaking! 本征晶体  
Intrinsic Crystal

## 1 3-5AR GE/SI

Substrate Material: GE / SI /CAF2

- ◆ 0° AOI AR Coating Line
- ◆ Design wavelength: AR @ 3000-5000NM
- ◆ Both Side AR Reflectance: R<1%
- ◆ Transmittance(ave) >99%@3000-5000NM

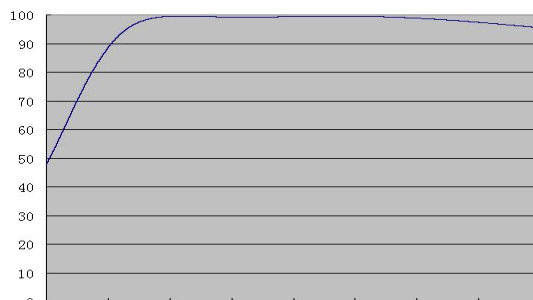

## 2 8-12AR GE

- ◆ Substrate Material: GE CAF2
- ◆ 0° AOI AR Coating Line
- ◆ Design wavelength: AR @ 8000-12000NM
- ◆ Both Side AR Reflectance: R<1%
- ◆ Transmittance(ave) >99%@8000-12000NM

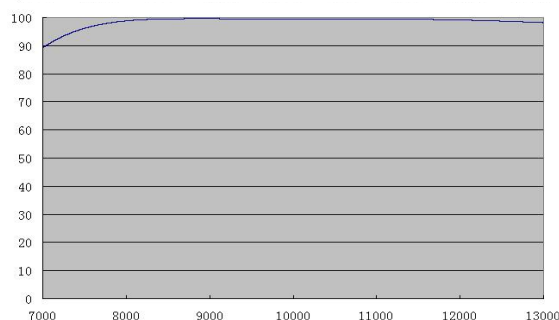

## 3 3000-5000NM AR+DLC

Substrate Material: GE / SI 3000-5000NM AR+DLC

- ◆ 0° AOI AR Coating Line
- ◆ Design wavelength: AR @ 3000-5000NM
- ◆ Side 1 3000-5000nm AR & Side 2 DLC
- ◆ Both Side Coating Transmittance(ave) >94%@3000-5000NM

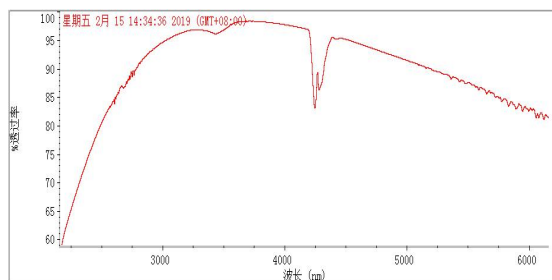

## 4 ZNSE 2-14AR

Substrate Material: ZNSE CAF2

- ◆ 0° AOI AR Coating Line
- ◆ Design wavelength: AR @2000-14000NM
- ◆ Both Side AR Transmittance(ave) >95%@2000-14000NM

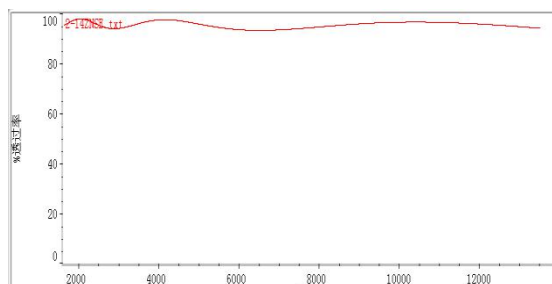

## 5 Laser Coating

- ◆ 0° AOI AR Coating Single Laser Line
- ◆ Design wavelength: AR@266nm,AR@355nm,AR@405nm,AR@532nm,AR@650nm,AR@808nm,AR@980,,AR@468nm,AR@1064nm,AR@1319nm,AR@1550nm,AR@2100nm
- ◆ Reflectance: R<0.2%

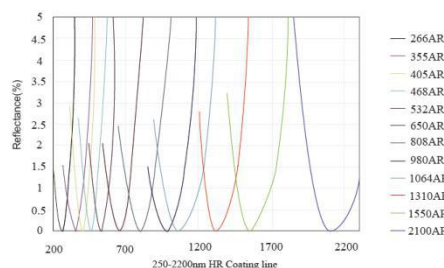

## 6 optical Coating

narrow bandpass filter

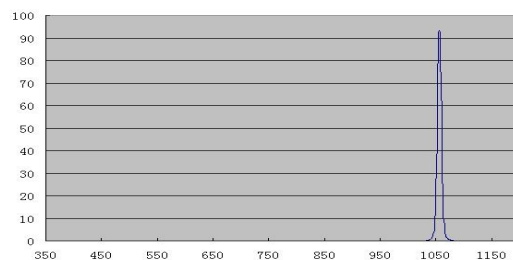



# How to make qualified silicon lens

## How to make qualified silicon lens

— FOR EXAMPLE OF D220MM SILICON LENS ORDER



### QUOTE PROCESS

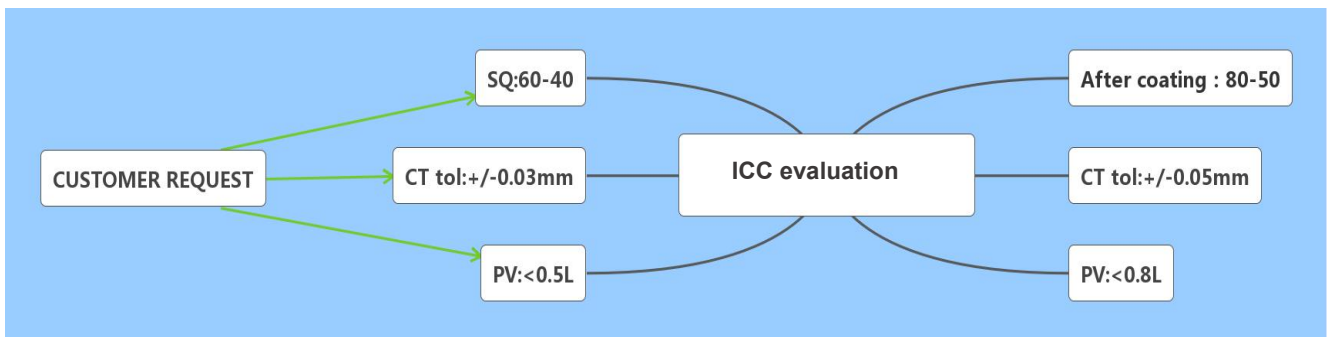

Silicon lens:

CA:85%. Diameter 220mm; center thickness +/-0.03mm; S/D 60-40; PV<0.5L; eccentricity <3 arcmin;

ICC provides a more cost-effective and higher yield indicator:

Center thickness +/-0.05mm; S/D before coat: 60-40;After coat: 80-50;Flatness: PV "0.8L

### ORDER PROCESS COURSE CONTROL:

Order 20 units; delivery time 40 days;then ICC will generated unique drawing number, and retained 3 years of document records

### ROHS , MSDS, Resistivity

Oreintation , Purity , T-curve

### Quantity:20+2units

Cut size : Dia+1.5mm , Ct+0.8mm

**Coating design**  
Coating peel-off test

**Cool hard work**  
5 years experience

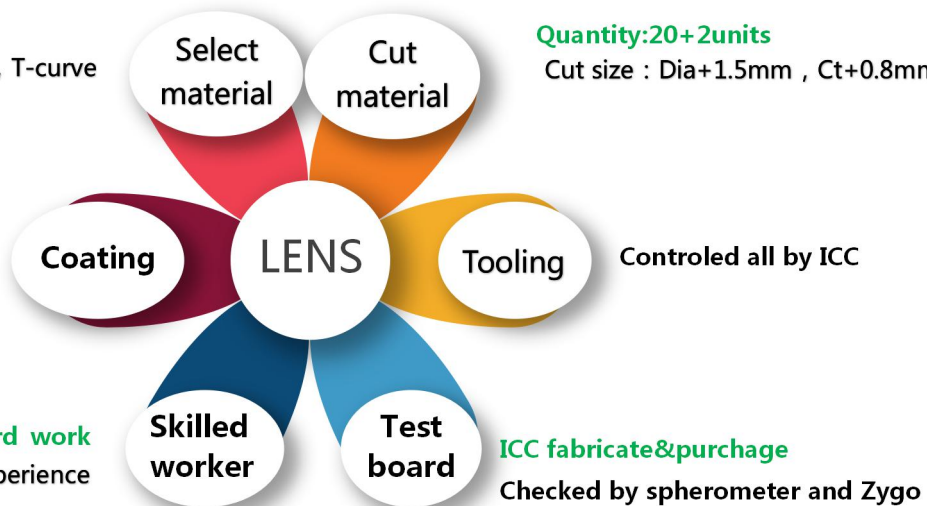

Controlled all by ICC

ICC fabricate&purchase  
Checked by spherometer and Zygo



**Material selection:** ROHS, MSDS, resistivity, crystal orientation, purity, transmittance measurement

**Processing flow control:**

**Cutting material:** 20+2 pieces, considering the centering cut edge need to be plus 1.5mm on diameter, consider removing the knives scratches and other defects, center thickness need to be plus 0.8mm

**Tooling& iron plate :** ICC homemade for important customers and key products,

**Testplate or test board:** ICC homemade&purchase from outside, radius accuracy measured by the spherometer and zygo interferometer before polishing.

**Processing:** Cool hard work.we let 5-year's skilled worker to make the whole procedure. If there is a problem during the processing, it must be reported to supervisor and leader within 2 hours to solve the problem.

**Coating control:**

Coating witness sample: 2 pieces (one for customer, one for ICC);

Coating curve:; two copies

Coating peel-off test: baking for 4 hours in 80°C temperature environment, then using 3M tape (25 \* 25mm)pulling the coating film, cooling for 4 hours in low temperature -15°C environment, then using 3M tape (25 \* 25mm) pulling coating film to check if peeled-off

**Time control:** Material and tooling preparation take 8 day; Sphere lens for 6 days; Grinding and polishing for 16 days, coating for 7 days, if there are accidents for 3 days, total of 40 days

## SHIPMENT&PACKAGE

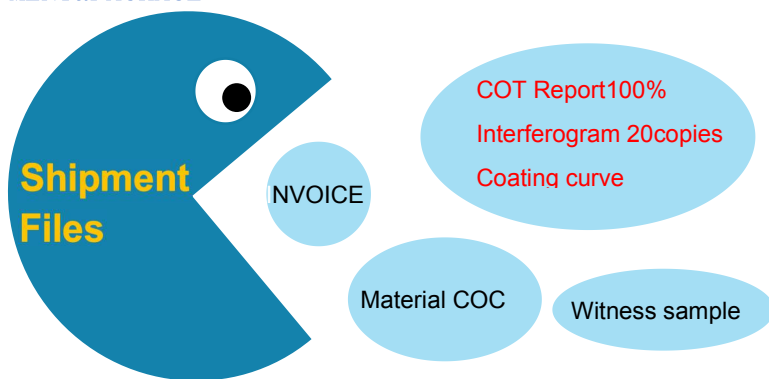

**Custom packaging:** single piece, single castle, 1 box of five castles

**Document in package box:**

Material Data Report: ROHS, Material Report,MSDS.

Test data report: 100% COT data; 20 copies of ZYGO interferogram; T-curve;

**Witness sample:**1 unit

Invoice&Packinglist: Provide invoice and waybill number within 24 hours after shipment

## AFTER-SALE

For quality complaint, we will send RMA report for analysis of the reason and point out the solution to customer within 24 hours.meantime,we will report to company leader of knowing the issue.After receiving the return products, ICC will carefully review the reasons and take measures to avoid such problems happen again.



Here we show the three standard stock optical components price.

1. Standard dimension FTIR instruments infrared optical windows.
2. Optical coating application round/wedge shape substrate and witness.
3. Standard optical calcium fluoride lens.



**Optical window** is the most normal used optical component, it can be used as windows of sensors and analyzes, or outside environmental protective windows, also used as optical coating substrate

*Main materials: CaF<sub>2</sub>, BaF<sub>2</sub>, MgF<sub>2</sub>, Si etc*

Dimension (mm)	CaF <sub>2</sub> (\$/pcs)	BaF <sub>2</sub> (\$/pcs)	MgF <sub>2</sub> (\$/pcs)	Si (\$/pcs)
6*1	2	3.5	5	2
10*1	2.5	4	5	2
12*1	3.5	8	5	2.5
12*3	4	8.5	7	3
13*1	3.5	8.5	5	2.5
13*2	3.5	8.5	6	3
15*1	4	9	6	3
15*2	4	10	7	4
17.5*4	9	16	12	8
18*5	10	18	14	8
19*2	5	10	9	5
20*2	5	10	9	5
20*2.5	5.5	10.5	10	5
20*3	6	11	12	5.5
22*4	7	14	20	6.5
25*1	6	10	10	5.5
25*2	6.5	14	13	6
25*4	8	17	20	7
25*5	9	20	23	8
25.4*2	7	12	13	6
30*2	9	16	22	8
30*5	12	28	35	11
32*3	10	23	26	11
37.5*4	13	32	50	12
38*6	17	48	68	16
40*5	17	45	60	16





Dimension (mm)	CaF2 (\$/pcs)	BaF2 (\$/pcs)	MgF2 (\$/pcs)	Si (\$/pcs)
41*3	14	30	42	
44*6	22	60	138	
49*6	26	65	155	
50*2	16	35	45	
50*3	19	42	60	
60*3.5	28	57	90	
75*2	30	67		
80*2	36	95		
95*4	75	150		
100*4	95	160		
120*3.5	150			

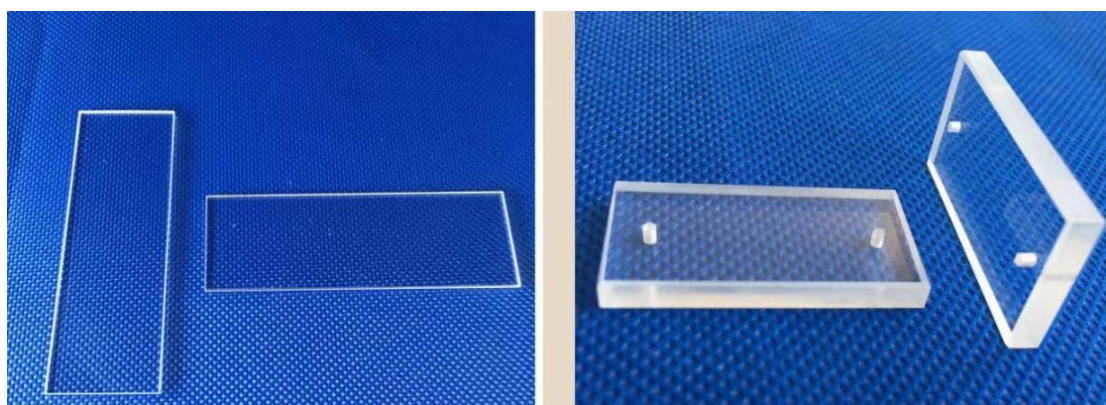

Dimension (mm)	CaF2 (\$/pcs)	BaF2 (\$/pcs)	MgF2 (\$/pcs)	Si (\$/pcs)
32*3D(Drilled)	16	35		
25*12*2	12	25		
29*14*4	16	40		
30*15*4	20	45		
38*19*4	25	60		
41*23*6	35	85		
41.3*23*4	32	80		
41.3*23*4(Drilled)	42	85		
41.3*23*6	36	85		
50*25*6	50	120		



Dia mm	CT	ET	Radius	FL	Material	Shape	wavelength nm	Unit price
12.7	4.1	2	10.5	25	CaF2	Plano-cx	2940	20
12.7	3	2	20.9	50	CaF2	Plano-cx	2940	20
12.7	2.6	2	31.4	75	CaF2	Plano-cx	2940	20
12.7	2.5	2	41.8	100	CaF2	Plano-cx	2940	20
12.7	2.3	2	62.7	150	CaF2	Plano-cx	2940	20
12.7	2.2	2	83.6	200	CaF2	Plano-cx	2940	20
12.7	2.2	2	104.6	250	CaF2	Plano-cx	2940	20
12.7	2.1	2	209.1	500	CaF2	Plano-cx	2940	20
12.7	3	3	418.2	1000	CaF2	Plano-cx	2940	20
25.4	7.9	2.1	16.7	40	CaF2	Plano-cx	2940	30
25.4	7.3	3	20.9	50	CaF2	Plano-cx	2940	30
25.4	5.7	3	31.4	75	CaF2	Plano-cx	2940	26
25.4	5	3	41.8	100	CaF2	Plano-cx	2940	24
25.4	5	3.4	52.3	125	CaF2	Plano-cx	2940	24
25.4	4.3	3	62.7	150	CaF2	Plano-cx	2940	24
25.4	4	3	83.6	200	CaF2	Plano-cx	2940	24
25.4	3.8	3	104.6	250	CaF2	Plano-cx	2940	24
25.4	3.7	3.1	125.5	300	CaF2	Plano-cx	2940	24
25.4	3.5	3	167.3	400	CaF2	Plano-cx	2940	24
25.4	3.4	3	209.1	500	CaF2	Plano-cx	2940	24
25.4	3.3	3	271.8	650	CaF2	Plano-cx	2940	24
25.4	3	2.7	313.7	750	CaF2	Plano-cx	2940	24
25.4	3.2	3	418.2	1000	CaF2	Plano-cx	2940	24
25.4	3.2	3.1	627.3	1500	CaF2	Plano-cx	2940	24
25.4	3.1	3	836.5	2000	CaF2	Plano-cx	2940	24
25.4	3.1	3	1254.7	3000	CaF2	Plano-cx	2940	24
50.8	15.9	2.9	31.4	75	CaF2	Plano-cx	2940	100
50.8	11.6	3	41.8	100	CaF2	Plano-cx	2940	85
50.8	8.4	3	62.7	150	CaF2	Plano-cx	2940	75
50.8	7	3.1	83.6	200	CaF2	Plano-cx	2940	75
50.8	5.6	2.5	104.6	250	CaF2	Plano-cx	2940	60
50.8	5.6	3	125.5	300	CaF2	Plano-cx	2940	60
50.8	5.6	3.7	167.3	400	CaF2	Plano-cx	2940	60
50.8	5	3.5	209.1	500	CaF2	Plano-cx	2940	60
50.8	5	4	313.7	750	CaF2	Plano-cx	2940	60
50.8	5	4.2	418.2	1000	CaF2	Plano-cx	2940	60
50.8	5	4.5	627.3	1500	CaF2	Plano-cx	2940	60
50.8	5	4.5	711	1700	CaF2	Plano-cx	2940	60
50.8	5	4.6	836.5	2000	CaF2	Plano-cx	2940	60

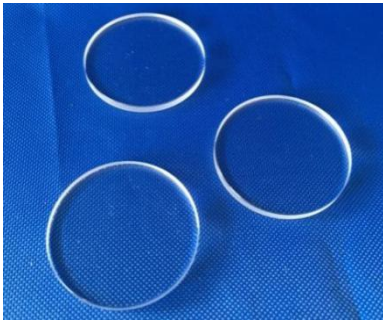

**Optical substrate/witness**

Diameter tolerance: +0.0/-0.1mm

Thickness tolerance: +/-0.12mm

CA > 90%

Flatness: 3L@633nm

S/D 60-40

Parallelism < 3Min Chamfer < 0.25mm Bevel < 0.3mm

Size(mm)	Material	Qty 25 unit price \$	Qty 50 unit price\$	Qty 100 unit price\$
25*1	CaF2	10	8	6
25*1	BaF2	14	12	10
25*1	MgF2	18	16	15
25*1	UVFS7980	12	9	6
25*1	Si	10	8	6
25*1	Ge	16	14	12
25*1	ZnS	24	22	20
25*1	ZnSe	24	22	20
25*1	BK7	10	7	5

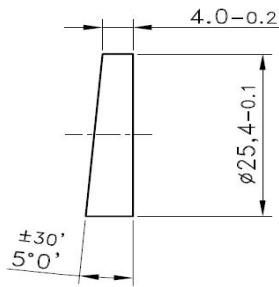
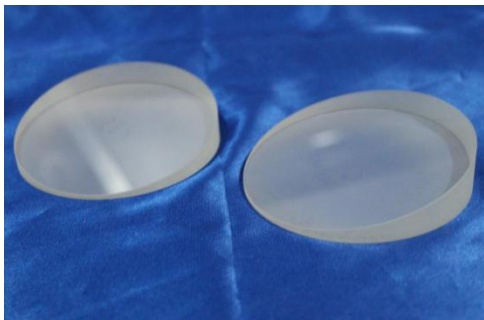

**Optical Wedge Substrate**

Diameter tolerance: +0.0/-0.1mm

Thickness tolerance: +0.0/-0.2

CA > 90%

Flatness: 3L@633nm

S/D 80-50

Wedge tolerance: +/-30'

Size(mm)	Material	Wedge Angle	Qty 25 unit price \$	Qty 50 unit price\$	Qty 100 unit price\$
25.4*4	CaF2	5°	28	25	22
25.4*4	UVFS7980	5°	25	22	20
25.4*4	Si	5°	28	25	22
25.4*4	Ge	5°	56	54	52
25.4*4	ZnS	5°	86	82	80
25.4*4	ZnSe	5°	80	78	75
25.4*4	BK7	5°	22	20	18

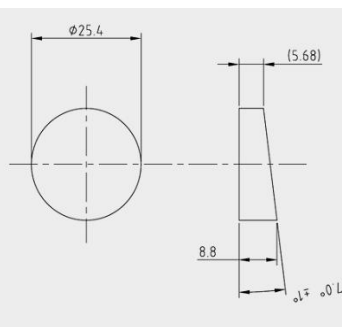
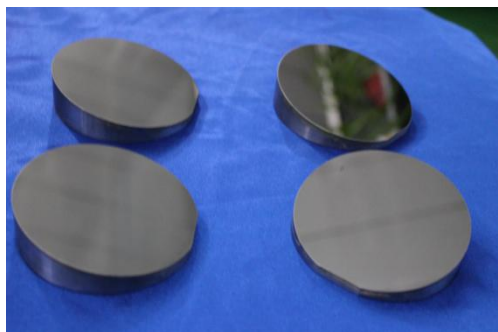

**Optical Wedge Substrate**

Diameter tolerance: +0.0/-0.1mm

Thickness tolerance: +0.0/-0.2

CA > 90%

Flatness: 3L@633nm

S/D 60-40

Wedge tolerance: +/- 1°

Size(mm)	Material	Wedge Angle	Qty 25 unit price \$	Qty 50 unit price\$	Qty 100 unit price\$
25.4*5.68	CaF2	7°	30	27	25
25.4*5.68	UVFS7980	7°	28	26	22
25.4*5.68	Si	7°	30	27	25
25.4*5.68	Ge	7°	65	62	60
25.4*5.68	ZnS	7°	90	88	88
25.4*5.68	ZnSe	7°	90	88	85
25.4*5.68	BK7	7°	25	22	20