

Operational Manual

CORSIGHT

Smart Vision System - Matrix | Line Scan



CORSIGHT

Operational Manual - rev. 2.0._10_2016

Please note that all data and illustrations are subject to error, change and omissions without notice.

IMPORTANT INFORMATION

This operational manual applies to the following models:

CO1041C2/M2 | CO4136C2/M2/IR2 | CO4206C2/M2 | CO1503C2/M2
COL6270M2 | COL6435M2

Table of Contents

Operational Manual	1
Smart Vision System - Matrix Line Scan.....	1
Table of Contents.....	2
Overview	5
Scope of Delivery.....	6
<i>Content</i>	6
<i>Options</i>	6
<i>Option Lighting</i>	6
<i>Option Tube Extension</i>	6
<i>Option Operating System</i>	6
<i>Cable Accessories</i>	6
Legal Notice	7
<i>Regulatory notices</i>	7
<i>RoHS</i>	7
Safety Precautions.....	8
<i>General Handling</i>	9
Usage Notes	11
<i>Handle carefully</i>	11
<i>Environmental operating conditions</i>	11
<i>Check a combination with the lens</i>	11
<i>Do not shoot under intense light</i>	11
<i>Dropping Frames</i>	11
<i>Occurrence of moiré</i>	12
<i>Occurrence of noise on the screen</i>	12
<i>Handling of the protective cap</i>	12
<i>If the equipment is not to be used for a long duration</i>	12
<i>Maintenance</i>	12

<i>Following information is only for EU-member states:</i>	13
System Requirements.....	14
<i>Standard conformity</i>	14
<i>GenICam</i>	14
<i>Environmental requirements</i>	14
Quick start	15
<i>Prepare the camera</i>	15
<i>Testing the camera</i>	15
<i>Basic camera features</i>	17
System architecture.....	21
<i>Overview</i>	21
<i>Dimensions</i>	22
<i>Mounting points</i>	22
<i>Housing</i>	23
<i>Lens mount, optical head</i>	23
<i>Integrated strobe ring</i>	23
<i>Sensor</i>	23
<i>Sensor types</i>	23
<i>IR-cut or AR filter</i>	24
<i>Changing or removing the filter</i>	25
<i>Cover glass</i>	25
<i>Input and output signals</i>	25
<i>DC power input</i>	26
<i>PC interfaces</i>	26
<i>Trigger input</i>	27
<i>Optocoupler interface</i>	27
<i>Serial port interface</i>	32
<i>Connector and cable description</i>	33
<i>I/O connector</i>	33
<i>PC system connector</i>	34
<i>Ethernet connector</i>	36

<i>Status LED</i>	37
Appendix A. Technical specifications for individual	38
Models.....	38
<i>CORSIGHT CO1041C2</i>	39
<i>CORSIGHT CO1041M2</i>	40
<i>CORSIGHT CO4136C2</i>	41
<i>CORSIGHT CO4136M2</i>	42
<i>CORSIGHT CO4136IR2</i>	43
<i>CORSIGHT CO4206C2</i>	44
<i>CORSIGHT CO4206M2</i>	45
<i>CORSIGHT CO1503C2</i>	46
<i>CORSIGHT CO1503M2</i>	47
<i>CORSIGHT COL6270M2 /COL6435M2</i>	48
Technical Support	49
<i>Websites</i>	49
<i>Email</i>	49
<i>Phone</i>	49
<i>Fax</i>	49
Imprint.....	50

Overview

CORSIGHT is a vision system with embedded computer providing maximum flexibility in industrial applications for decentralized image processing. CORSIGHT runs under Windows or Linux and with any common image processing software. Its solid housing, interfaces and connectors are in accordance to industrial standards.

product name	CORSIGHT
PC technology	Embedded PC with Intel Atom E3845 1.91GHz 4 GB DDR3/1333MHz (up to 8 GB on request) 16 GB built-in SATA-SSD flash disk (up to 32 GB on request) µSD card slot Gigabit Ethernet interface, USB 2.0 interface, DP++ output 2× WLAN/Bluetooth antenna connector, LUT for image manipulation MPEG-4/H264 encoder/decoder
sensors	CMOS, monochrome/NIR & Bayer encoded color, progressive scanning, various trigger modes
sensor specific information	Refer to Appendix A, Technical specifications for individual models
image acquisition & transfer	DMA to the CORSIGHT host memory
lens mount	C-mount (CS-mount on request)
dimensions	65×109×73 mm (W×H×D, without connectors)
weight	516 g
power input	24 ±10% VDC, 15 W (typical), 25 W (max.) or PoE+
digital I/O	4×opto in, 4×opto out, TTL in, TTL out, RS232 interface
supported operating systems	Microsoft Windows Embedded Standard 7 (WES7), Linux
DMA	Directly supported image processing libraries Adaptive Vision Studio, Halcon, ActivVisionTools, Common Vision Blox, MATLAB, OpenCV
order information	contact our sales team > http://net-gmbh.com/

Scope of Delivery

Content

- CORSIGHT housing camera
- CD-ROM with SynView (SDK) for Microsoft Windows Embedded Standard 7 and Linux compatible to GenICam, GenTL and GigE Vision standards including
 - SynView Explorer to control CORSIGHT cameras
 - A comprehensive programming library with automatic source code generator
 - SynView GigE Vision Configuration Tool
 - Firmware maintenance tool
 - Software drivers for CORSIGHT and all related hardware software documentation

Free of charge software updates are listed in the [download area](#) on NET's website.

Options

Any CORSIGHT basic model (see [Appendix A, Technical specifications for individual models](#)) can be further customized. Please contact NET for more information about NET's current offering and pricing.

Option Lighting

- CORSIGHT Flash light module, IR (order no. 01007200xx)
- CORSIGHT Flash light module, cool white, 6500K (order no. 01007300xx)

Option Tube Extension

- CORSIGHT Tube, length 50.5mm (order no. 60015001xx)

Option Operating System

- Windows Embedded Standard 7 License

Cable Accessories

- CORSIGHT LAN cable, RJ45, 5m (order no. 06093900xx)
- CORSIGHT Camera Cable for DP++, USB, RS232 (order no. 06100400xx)
- CORSIGHT Camera Cable for I/O, Power supply, 3m (order no. 06095000xx)

Legal Notice

Regulatory notices

The cameras should be used with properly shielded cables (and other equipment) as recommended in this manual.

Please contact us if you need further information regarding the necessary equipment.

RoHS

The product fulfills the requirements of the **EU directive RoHS 2011/65/EU** in the currently valid version from 8.June 2011 regarding the restrictive use of certain hazardous materials in electric applications within the allowable limits.

Safety Precautions

Before using this product, read these safety precautions carefully. Important information is shown in this Operational Manual to protect users from injuries and property damages, and to enable them to use the product safely and correctly. Please be sure to thoroughly understand the meanings of the following signs and symbols before reading the main text that follows, and observe the instructions given herein.

[Definition of Safety Signs]

Safety Signs	Description
 WARNING	Indicates a potentially hazardous situation that may result in death or serious injury (*1) in the event of improper handling.
CAUTION	Indicates a potentially hazardous situation that may result in light to moderate injuries (*2) or only in property damage (*3) in the event of improper handling.



Notes

*1: "Serious injury" refers to cases of loss of eyesight, wounds, burns (high or low temperature), electric shock, broken bones, poisoning, etc., which leave after-effects or which requires hospitalization or a long period of outpatient treatment of cure.

*2: "Light to moderate injuries" refers to injuries, burns, electric shock etc. that do not require hospitalization or long-term treatment.

*3: "Property damage" refers to cases of extensive damage involving damage to buildings, equipment, farm animals, pet animals and other belongings.

[Explanation of Safety Symbols]

Safety Symbols	Description
 PROHIBITED	This sign indicates PROHIBITION (Do not). The content of prohibition is shown by a picture or words beside the symbol.
 MANDATORY	This sign indicates MANDATORY ACTION (You are required to do). The content of action is shown by a picture or words beside the symbol.

General Handling

WARNING



Unplug

Stop operation immediately when any abnormality or defect occurs. If abnormal conditions are present, such as smoke, a burning smell, ingress of water or foreign matter, or if the equipment is dropped or malfunctions, fire or electric shock may result. Be always sure to disconnect the power cable from the wall socket at once and contact your dealer.



Never pull apart

Do not disassemble, repair, or modify the equipment. Otherwise, fire or electric shock may result. For internal repair, inspection, or cleaning, contact your sales representative.



Avoid

Do not place anything on the equipment. If metallic objects, liquid, or other foreign matter enters the equipment, fire or electric shock may result.

Avoid

Do not install the equipment in an unstable or inclined location or locations subject to vibration or impact. Otherwise, the equipment may topple over and cause personal injury.



Do not touch

During an electrical storm, do not touch the power cable and the connection cable. Otherwise, an electric shock may result.



Instruction

Use the specified voltage. Use of an unspecified voltage may result in fire or electric shock.

Avoid

Do not handle roughly, damaged, fabricated, bent forcefully, pulled, twisted, bundled, placed under heavy objects or heated the power cable and the connection cable. Otherwise, fire or electric shock may result.

CAUTION



Observe the following when installing the equipment:
Do not cover the equipment with a cloth, etc.
Do not place the equipment in a narrow location where heat is likely to accumulate.
Otherwise, heat will accumulate inside the equipment, possibly resulting in a fire.

Instruction

Use only specified the power cable and the connection cables. Otherwise, fire or electric shock may result.

Instruction



Avoid

Do not give strong impact against the equipment. It may cause the trouble.



Instruction

When performing connection, turn off power. When connecting the power cable and the connection cable, turn off the equipment power. Otherwise, fire or electric shock may result.

Do not expose the camera head to any intensive light (such as direct sunlight). Otherwise, its inner image pickup device might get damaged.

Avoid

Avoid short-circuiting signal output. Otherwise, a malfunction may occur.

Avoid

Avoid giving a strong shock against the camera body. It might cause a breakdown or damage. If your camera is used in a system where its camera connector is subjected to strong repetitive shocks, its camera connector is possible to break down. If you intend to use your camera in such a situation, if possible, bundle and fix a camera cable in the place near the camera, and do not transmit a shock to the camera connector.

Avoid

Usage Notes

Handle carefully

Do not drop the equipment or allow it to be subject to strong impact or vibration, as such action may cause malfunctions. Further, do not damage the connection cable, since this may cause wire breakage.

Environmental operating conditions

Do not use the product in locations where the ambient temperature or humidity exceeds the specifications. Otherwise, image quality may be degraded or internal components may be adversely affected. In particular, do not use the product in areas exposed to direct sunlight. Moreover, during shooting under high temperatures, vertical stripes or white spots (noise) may be produced, depending on the subject or camera conditions (such as increased gain). However, such phenomena are not malfunctions.

Check a combination with the lens

Depending on the lens and lighting you use, an image is reflected as a ghost in the imaging area. However, this is not because of a fault of the camera. In addition, depending on the lens you use, the performance of the camera may not be brought out fully due to deterioration in resolution and brightness in the peripheral area, aberration and others. Be sure to check a combination with the camera by using the lens and lightning you actually use. When installing a lens in the camera, make sure carefully that it is not tilted. In addition, use a mounting screw free from defects and dirt. Otherwise, the camera may be unable to be removed. Install a next lens; its dimension of protrusion from bottom of the screw is equal to or less than 10 mm. If a lens does not stand to this condition, it might not be installed to this camera.

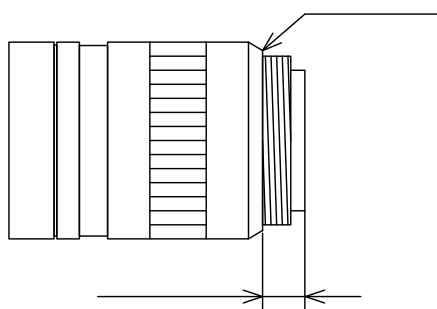

Do not shoot under intense light

Avoid intense light such as spot lights on part of the screen because it may cause blooming or smears. If intense light falls on the screen, vertical stripes may appear on the screen, but this is not a malfunction.

Dropping Frames

Depends on your PC or Gigabit Ethernet interface board configurations, images may not be captured properly (e.g. dropping frames). In this case, change to frame rate setting lower.

Do not expose the camera's image-pickup-plane to sunlight or other intense light directly. Its inner image sensor might be damaged.

Occurrence of moiré

If you shoot thin stripe patterns, moiré patterns (interference fringes) may appear. This is not a malfunction.

Occurrence of noise on the screen

If an intense magnetic or electromagnetic field is generated near the camera or connection cable, noise may be generated on the screen. If this occurs, move the camera or the cable.

Handling of the protective cap

If the camera is not in use, attach the lens cap to the camera to protect the image pickup surface.

If the equipment is not to be used for a long duration

Turn off power to the camera for safety.

Maintenance

Turn off power to the equipment and wipe it with a dry cloth. If it becomes severely contaminated, gently wipe the affected areas with a soft cloth dampened with diluted neutral detergent. Never use alcohol, benzene, thinner, or other chemicals because such chemicals may damage or discolor the paint and indications. If the image pickup surface becomes dusty, contaminated, or scratched, consult your sales representative.

Following information is only for EU-member states:



The use of the symbol indicates that this product may not be treated as household waste. By ensuring this product is disposed correctly, you help to prevent potential negative consequences for the environment and human health, which could otherwise be caused by inappropriate waste handling of this product. For more detailed information about the take-back and recycling of this product, please contact your supplier where you purchased the product.



Do not throw batteries and rechargeable batteries into the household waste!
Customers are legally obliged to return used and rechargeable batteries, whether they contain harmful substances or not, designated disposal sites or collecting sites in shops selling batteries. By doing so you are contributing to a better and cleaner environment.

System Requirements

Standard conformity

GenICam

The cameras (and supporting libraries) fully implement the GenICam standard, including SFNC (Standard Features Naming Convention) and GenTL. Thanks to the full GenTL compatibility, the cameras are plug & play compatible with all GenTL capable libraries, such as Adaptive Vision Studio, Halcon, Common Vision Blox or MATLAB. CORSIGHT supports the operating systems Microsoft Windows Embedded Standard 7 and Linux.

Environmental requirements

- operating temperature: 0 °C - 50 °C
- operating relative humidity: 20% - 95%, non-condensing
- allow sufficient air circulation around the camera to prevent heat-up
- ingress protection rating: IP67

If exposed to environmental conditions outside the specified limits, the camera performance can be significantly degraded or the camera can be damaged.

Quick start

This chapter is intended to help users wanting to start quickly with basic usage of the cameras, without studying the entire documentation. The information in this chapter duplicates information in the following parts of the manual. Whenever in doubt, please refer to the corresponding chapters of the manual, providing detailed description of given problems.

Prepare the camera

- Unpack the camera, connect all the necessary peripheral. If needed, check the interface connectors description in Section, “Connector and cable description” .
- Power up the camera using proper 24V power supply.
- Assuming that the desired operating system is already pre-installed on the camera, no additional steps are needed and the camera is ready for SynView installation and test. Otherwise, install the operating system, following instructions of the operating system supplier. Install the necessary device drivers available from our [download area](#).

Testing the camera

The SynView package contains the SynView Explorer tool, which allows to enumerate, connect and configure camera, acquire images or generate sample source code for SynView API. It is a useful tool for testing both the SynView and camera functionality.

Start the tool from system menu: Start → Programs → SynView → SynView Explorer (under Linux, run /opt/synview/bin/sv.explorer).

Connect the camera to be tested — select it in the list of found cameras and press the Connect camera button.

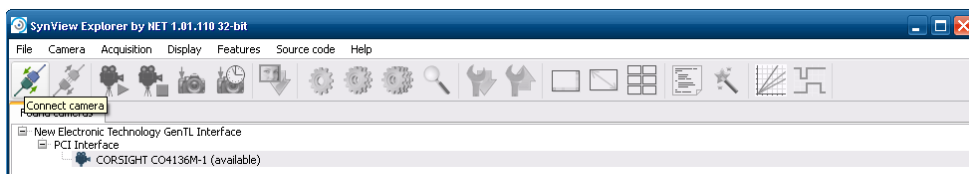

Configure the camera features as desired. Pay attention especially to features in Image Format Control and Acquisition Control categories.

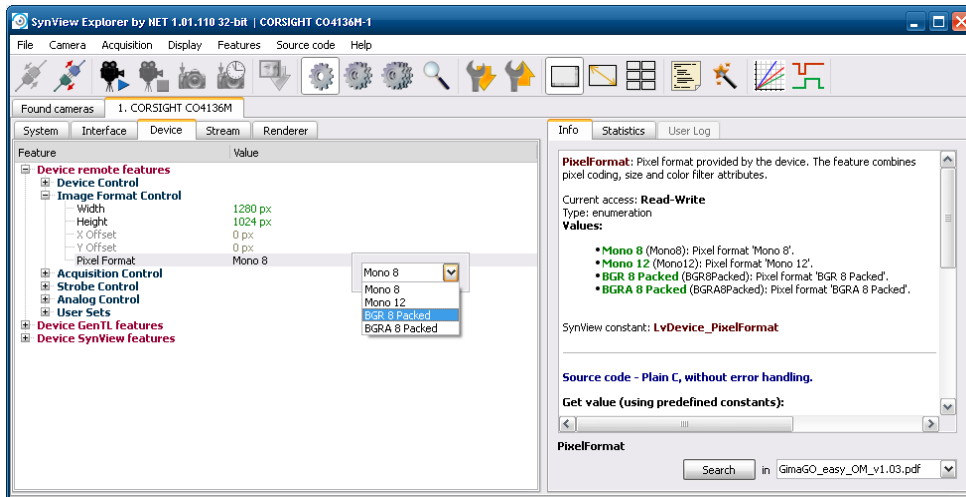

When prepared, click the Start acquisition button — the camera should start acquiring. If not, verify again, if the camera was not set to triggered mode, while no trigger was attached.

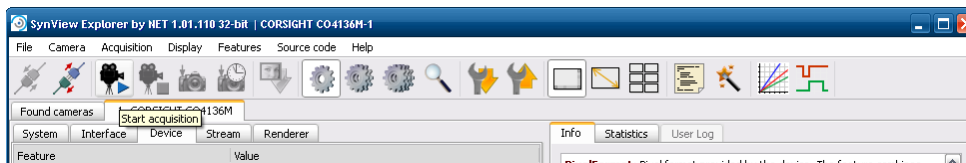

While the acquisition is active, you can still adjust the runtime parameters, such as exposure time or gain. Basic acquisition parameters, such as pixel format or trigger mode become locked when the acquisition starts.

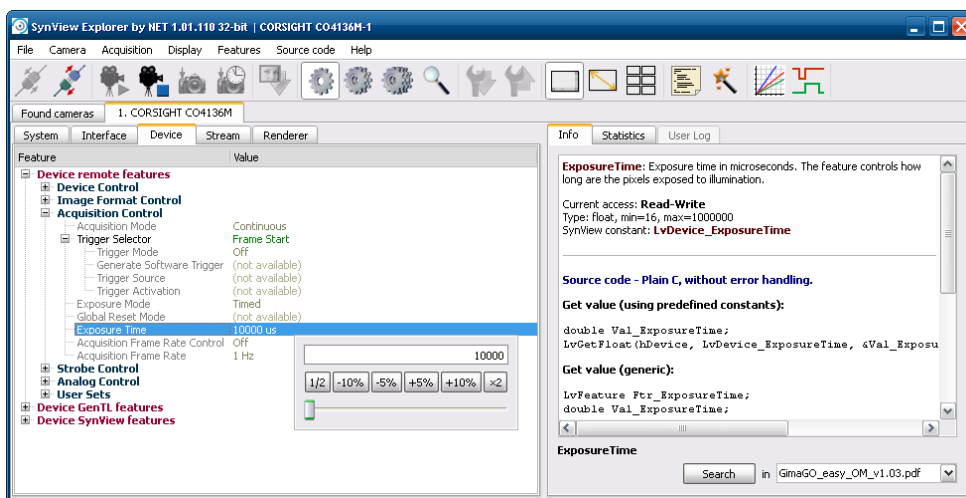

- When finished, click the Stop acquisition button and exit.

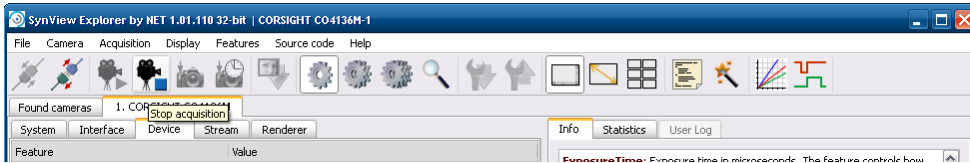

Basic camera features

This section shows the most essential camera features relevant for the basic tests.

The SynView Explorer displays by default only the “basic” camera features intended to handle the most common tasks. To display also the more advanced features, you need to switch to the “expert” feature level. Note that the third available level, “guru”, is intended just for debugging and should not be used for normal operation.

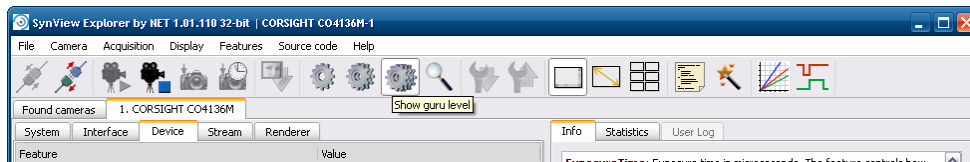

Image format. The basic properties of the acquired image can be configured through features in the **Image Format** category:

Pixel format

The Pixel Format feature is an enumeration allowing to specify the type of image data delivered to the application buffer. The available pixel formats differ among camera models. In general, they can be

- Monochrome, with various number of bits per pixel, eg. Mono 8 or Mono 12.
- Bayer encoded, with sensor-dependent Bayer formats, eg. Bayer GR 8 or Bayer BG 8. In this case the application needs to decode the Bayer encoded image buffer to get a proper color image — SynView API provides functions for this.
- RGB color format, providing true RGB output, in this case the Bayer decoding is performed directly by the camera.

Image size

The camera will acquire full size image by default. The acquired image size can be reduced using the Width and Height features, which set the acquired image size in pixels. The field of view will be automatically centered within the full sensor image.

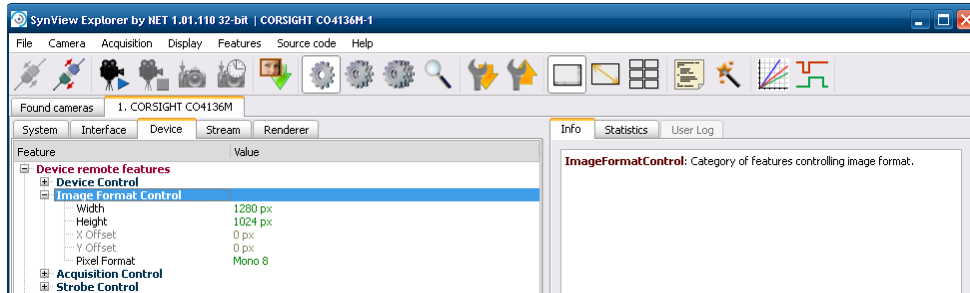

Acquisition parameters. The luminance of the acquired image can be controlled either explicitly through exposure time and gain functions, or automatically through corresponding auto-functions.

Exposure time

The Exposure Time feature in Acquisition Control category configures the length of the exposure in microseconds.

Analog gain

Analog gain to be applied on the sensor during acquired image digitization can be configured through corresponding features in Analog Control category. Verify that the Gain Selector feature is set to Analog (some cameras models support also digital gain). Now the Gain feature controls the desired analog gain value in decibel.

Auto-functions

Selected camera models support automatic gain and/or automatic exposure functions, when the camera keeps adjusting given parameter automatically, to maintain constant image luminance. The features will be displayed in the feature tree only if the camera supports them. To switch the auto function on, navigate to corresponding control feature, Automatic Exposure in Acquisition Control category or Automatic Gain in Analog Control category and switch them from Off to Continuous.

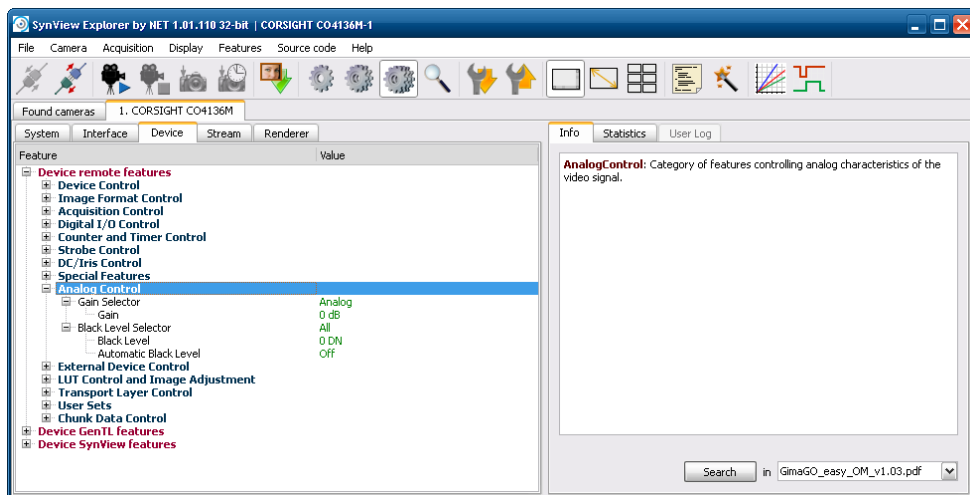

Triggered acquisition. The camera starts by default in “free running” mode — acquiring continuous stream of image frames. On the other hand in the triggered mode, the acquisition of individual frames can be explicitly

controlled by hardware or software triggers. The trigger related features are located in the Acquisition Control category.

Triggered mode

To switch the camera to triggered mode, open the Trigger Selector subtree and set Trigger Mode to On. After starting the acquisition again, the camera will acquire images only when explicit trigger signal arrives.

Trigger source

The Trigger Source enumeration allows to select where should the camera “listen for triggers. You can select either Software or one of the camera's I/O lines. The assignment of the I/O lines to the connector pins is described in Section, “[Connector and cable description](#)” .

Software triggering

The software triggers can be issued during active acquisition in triggered mode, regardless whether the trigger source is set to Software or a physical I/O line. To apply the software trigger, select the Generate Software Trigger feature and click the button in the tool bar.

Strobe

The strobe can be configured using features in the Digital I/O Control category, after switching the feature visibility level to “expert”. Select the desired output line, where the strobe pulses should be applied through Line Selector (the I/O line mapping to interface connector pins is described in Section, “[Connector and cable description](#)”). Switch the strobe on for the selected line by setting Line Source to Exposure Active. The camera will issue a strobe pulse aligned with the exposure for every acquired frame. The strobe output is available only in triggered mode. In case the camera has an integrated Strobe Ring, its Strobe can be controlled through the Strobe Control category. Select which Clusters to use with Strobe Enable. Strobe Duration sets the length of the Strobe Pulse.

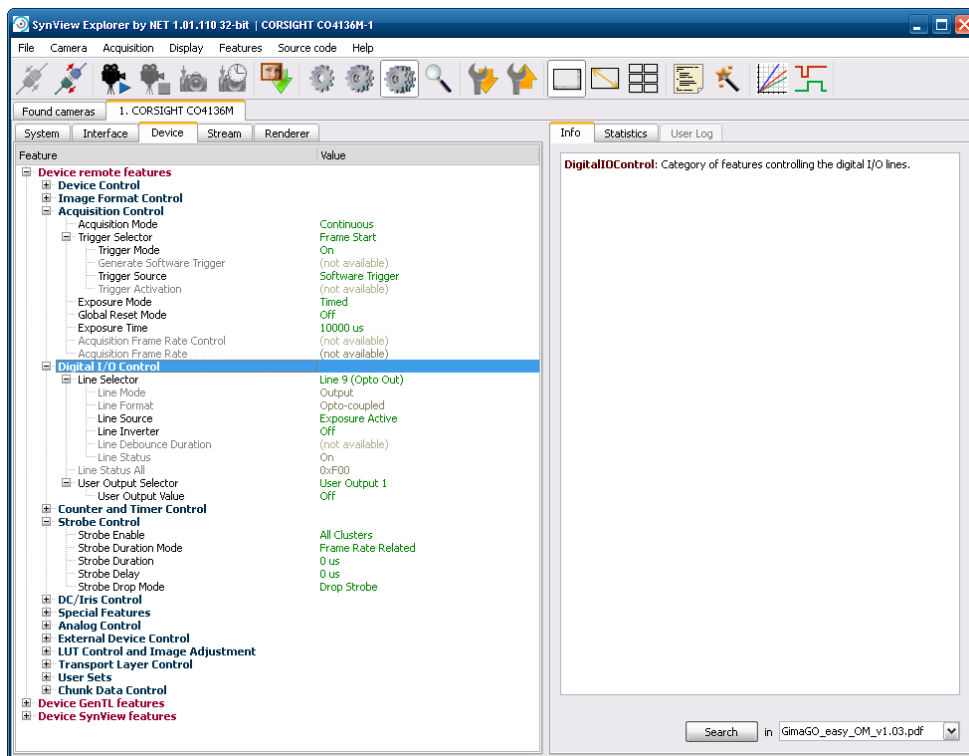

Information about the camera. It is frequently necessary to query the basic information about the camera. The information is available through features in the Device Control category.

Device identity

The most important features identifying the camera are Vendor Name and Model Name. The camera's serial number is stored as string in feature Device ID (available only in “expert” feature level). Finally, the “nick-name” used to identify the device is accessible (read/write) in DeviceUser ID.

Firmware version

The version of the firmware loaded on the camera is accessible as string in feature Device Firmware Version.

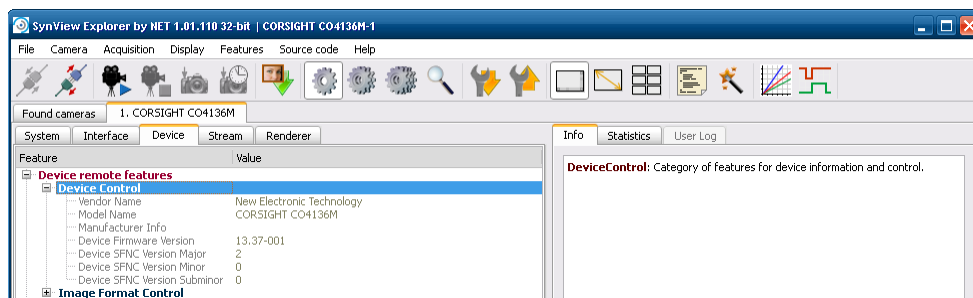

System architecture

Overview

CORSIGHT is a complete embedded PC system built around intel Atom processor (Atom E3845 1.91GHz) of the intel embedded roadmap. Any of the wide choice of NET's sensors may be used in CORSIGHT. The PC offers LAN/WLAN, DP++ as well as USB 2.0 interface. Different boot and storage media exist.

Sensor data is acquired and possibly preprocessed using an FPGA based subsystem. The pre-processing options include, input look-up-table, format conversion, and buffering, before the data is transferred to the main PC using the high performance PCI-Express DMA transfer. General purpose I/O's (optocoupler & TTL inputs and outputs, RS232 interface) enable the control of external devices.

Dimensions

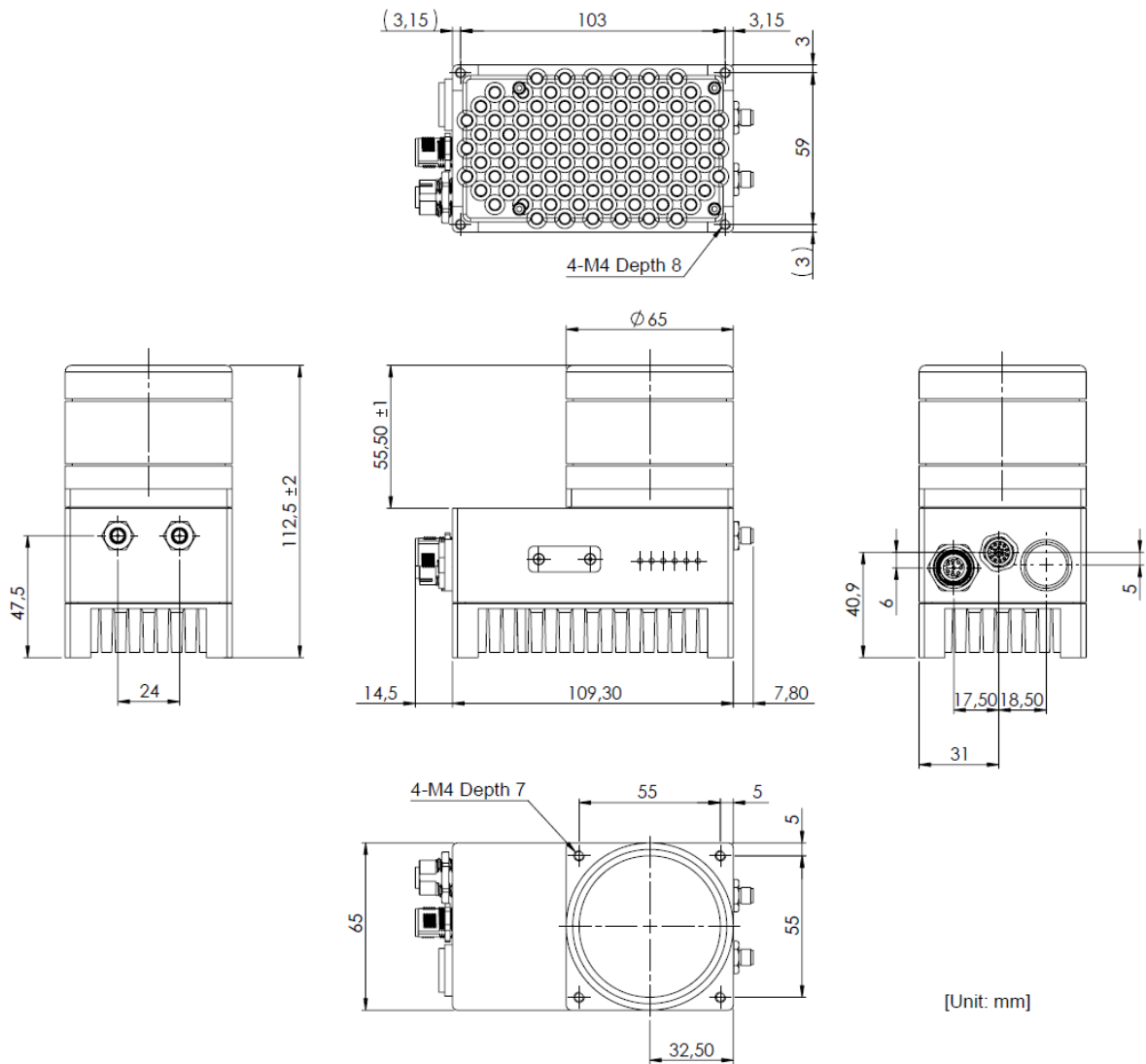

Mounting points

The mounting points' position and size is illustrated in section , “[Dimensions](#)” .

The following mounting points are available:

- Four M4×10 points in front panel of the camera (the side of the lens mount).
- Four M4×10 points in back panel of the camera.

Housing

CORSIGHT is offered with a IP67 housing (solid particle protection: dust tight, liquid ingress protection: immersion up to 1m).

Lens mount, optical head

All the models are equipped with a C-mount optical head (1-inch thread diameter, 32 threads per inch, 17.526 mm flange back). CS-mount version (identical, only with 12.5 mm flange back) is available on request for high volume OEM customers.

Integrated strobe ring

The CORSIGHT camera can be optionally equipped with an integrated strobe ring that can be software-controlled directly from the camera's feature interface.

Contact NET to learn the available strobe ring types and their specifications.

Sensor

Sensor types

Progressive scanning

All NET cameras provide progressive scan video output. The camera outputs full frame data in sequential order (no field interlacing).

CMOS: global vs. rolling shutter

Some of the cameras with large CMOS sensors are equipped with a rolling shutter. In contrary to the global shutter, where all camera pixels are exposed at exactly the same time, with rolling shutter the exposure of every single line is slightly time-shifted relative to the previous line. This requires some special considerations, especially when capturing moving objects. Flash illumination is desirable.

IR-cut or AR filter

All cameras have by default an IR-cut (color) or AR (mono) filter mounted on top of the sensor. The user has however an option to choose from different configurations:

- IR-cut filter with 650nm filter mounted on top of the sensor
- Clear glass filter (of the same size as the original IR-cut filter) mounted on top of the sensor. Check, whether you don't need special lens designed for specifically for use without IR-cut filter (common lens might not focus properly in the infrared band or show other problems).
- Daylight blocking filter.
- Without any sensor cover mounted. This has impact on optical properties of the camera — the C-mount flange distance from the sensor is accurately adjusted for the use of the IR-cut filter and removing the filter decreases the length of the optical path. With some lenses and working area setups it can become impossible to focus properly.

Taverage	≥ 92%	420nm	620nm
Tmin	≥ 88%	420nm	620nm
T	= 50%	650nm	± 10nm
Taverage	≤ 5%	690nm	1100nm

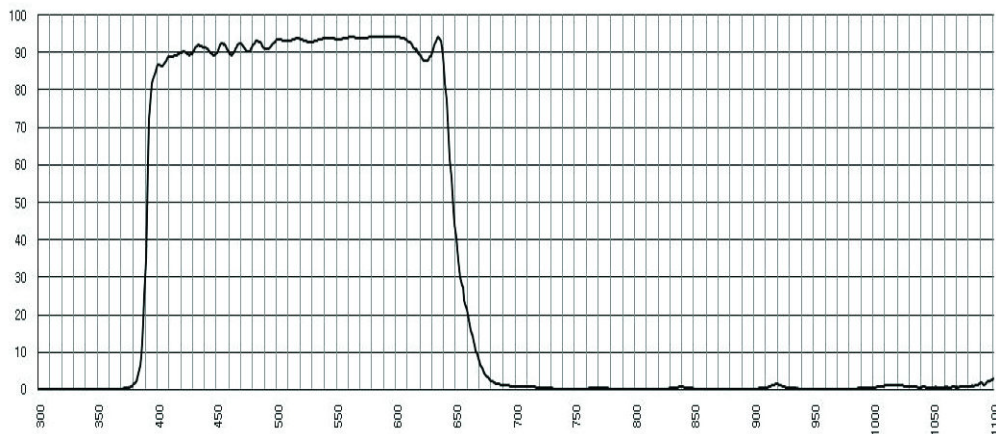

IR cut filter characteristics for color cameras

Tave.	≥ 97%	420nm	680nm
Tabsn	≥ 92%	420nm	680nm

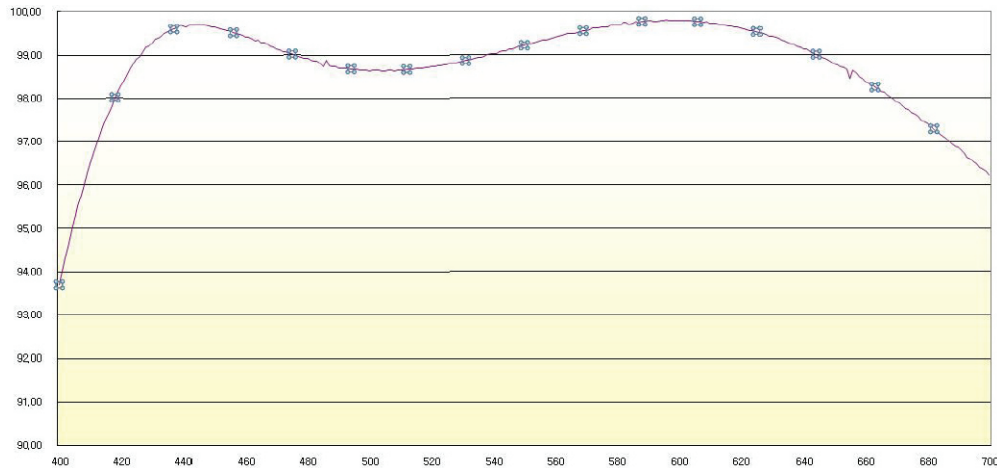

AR filter characteristics for BW cameras

Changing or removing the filter

The filter is accessible from outside the camera and user can change it without loose of warranty. It is very important to do this operation with maximum care so that the image sensor cannot be damaged.

If exchanging the filter for another type, it is highly recommended to choose a filter of the same size, not to change the optical properties of the system. Removing the filter completely will change the length of the optical path which can lead to focusing problems in some scenarios.

To mount/dismount the filter, you will need a hexagonal screwdriver number 1.5. The fixing screws are M2×3.

It's important to keep in mind that when changing or removing the filter, not only can be the sensor damaged, but also dust or other dirt can get inside the camera and especially on top of the sensor itself. It is necessary to perform such operation in appropriately clean environment and using suitable tools preventing any sensor dust pollution.

Cover glass

thickness: 3mm
type: float glass

Input and output signals

This section describes all types of input and output signals available on CORSIGHT cameras, including their characteristics and when necessary including connection examples. Location and pinouts of the

connectors carrying the signals is documented in Section [“Dimensions”](#) and Section [“Connector and cable description”](#)

DC power input

CORSIGHT cameras are designed for power supply input range of 24 V \pm 10%. The power consumption strongly depends on the connected peripherals — devices being powered by CORSIGHT through the USB or other interfaces. The power consumption of the CORSIGHT itself is typically 15 W, while the total power consumption, including the connected peripherals, should not exceed 25 W. A suitable power supply for CORSIGHT is available from NET.

The customers designing an own power supply will find the information about the power input connector in Section [“I/O connector”](#).

Power over Ethernet (PoE+)

The CORSIGHT cameras can be also powered using the Power over Ethernet option. The cameras are compatible with the Power over Ethernet standard, versions IEEE 802.3af and 802.3at. They should be used with PoE switches (“endspans”) or power injectors (“midspans”) complying with the IEEE 802.3af/IEEE 802.3at specifications.

Both PoE modes (A and B) are supported by the camera. Beware of using the PoE cameras with 100Mbit Ethernet only cables, where the “spare” wire pairs might be omitted. With such cable, the power wouldn't be delivered when using Mode B compatible power sourcing equipment.

The CORSIGHT camera models are classified in the power level class 4. The power consumption with PoE is slightly higher than consumption with “regular” power supply. When connecting multiple CORSIGHT cameras to a single PoE switch, verify, how much total power the switch can provide and how it handles cases when the limit is exceeded.

PC interfaces

For completeness, the PC interfaces of the CORSIGHT camera are again listed below. The components driving individual principal interfaces are described in Section [“System architecture”](#).

Ethernet

CORSIGHT provides a Gigabit Ethernet connectivity (compatible also with 10Mb/100Mb/1GB networks).

Display

CORSIGHT connects with Displayport compatible displays. The DP interface is available through a custom connector (Section [“PC system connector”](#)), adapter cable with standard DP++ connector is available.

USB

A USB port is available through a custom connector (Section [“PC system connector”](#)). Standard Type A connector is available over an adapter cable.

μSD card

Slot for μSD cards.

WLAN

WLAN/Bluetooth interface, including two WLAN antenna connectors.

Trigger input

Any of the available optocoupler inputs or TTL inputs can be used for triggering. The input line mapping on the camera connectors is described in Section “[Connector and cable description](#)”.

The characteristics and default behavior of these interfaces are described below in Section “[Optocoupler interface](#)” and Section “[TTL I/O's](#)”. Those sections also provide examples how to connect the inputs.

Optocoupler interface

Optically isolated inputs and outputs.

Optocoupler basics

An optocoupler is a device using optical path to transfer an electronic signal between two circuits. It basically consists of a photodiode converting the input signal to light and a phototransistor converting the light again to electronic signal.

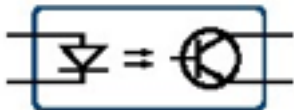

Diagram of basic optocoupler function

The optocoupler is useful in situations where one part of the circuit needs to be galvanically isolated from the other part to prevent damage or unwanted interference. It is used to prevent ground loops or to block voltage spikes.

For effective use of the optocoupler it is important to control it using an independent power supply. When the external circuit is galvanically connected to the camera (eg. when reusing the camera's power to control the optocoupler), the optocoupler's protective function is eliminated.

Optocoupler inputs

The CORSIGHT camera is equipped with four optically isolated input lines. One input optocoupler is fully independent, the other three are connected with a common cathode (Section “[I/O connector](#)”) due to limited number of pins on the I/O connector.

The optocoupler input's logical state is understood as logical 0 if no current is flowing through the optocoupler diode, logical 1 if current is flowing through the diode.

The optocoupler is guaranteed to be switched on (logical 1 status) when the voltage applied to the input is within range of 5–24 V (tolerance 10%). It is guaranteed to be switched off (logical 0) when the applied voltage is under 1.5 V. The input status is undefined between 1.5 and 4.5 V, the input voltage must not exceed the 24 V limit.

The optocoupler inputs have no protection against wrong polarity. Be sure to connect them always with correct polarity according to the documented wiring diagrams and connector pinouts.

The nominal input current is 7.5 mA — the input signal must be able to deliver at least this amount of current.

The optocoupler inputs are TTL compatible provided that the signal source is capable of supplying the input current of 7.5 mA.

The optocoupler input lines are equipped with a debouncer to prevent generating unwanted input signals.

The input lines are using fast optocouplers: the propagation time is under 125 ns, for both rising and falling signal edge (assuming input signal with strongly steep edge). The exact switching speed may vary with temperature and the used input voltage level — the listed specifications are the worst case values.

Optocoupler input parameters summary

Parameter	Value
Operating voltage	5-24 V
Input current	7.5 mA
External resistor requirement	No
ON voltage level	> 4.5 V
OFF voltage level	< 1.5 V
OFF to ON delay	< 125 ns
ON to OFF delay	< 125 ns
OFF to ON jitter	± 5 ns
ON to OFF jitter	± 5 ns

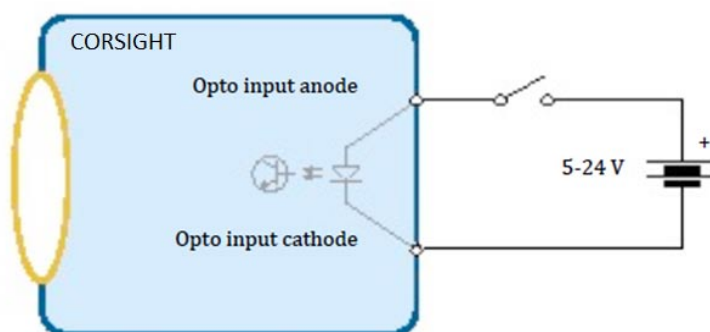

Example of using the optocoupler inputs

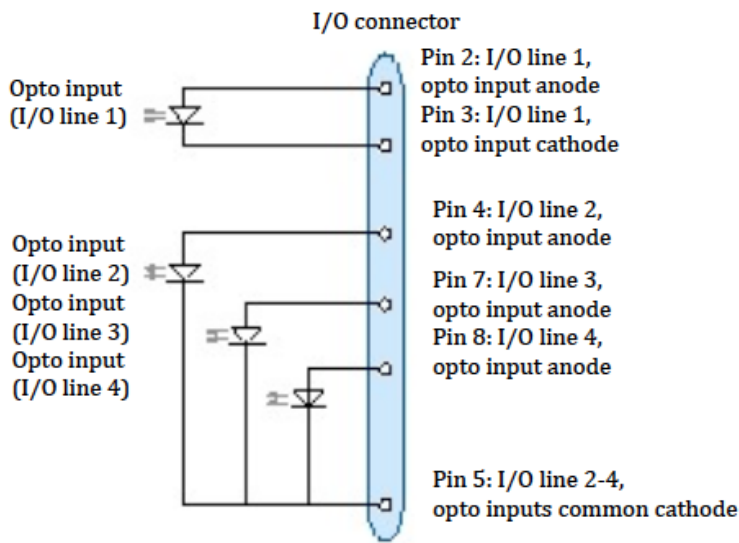
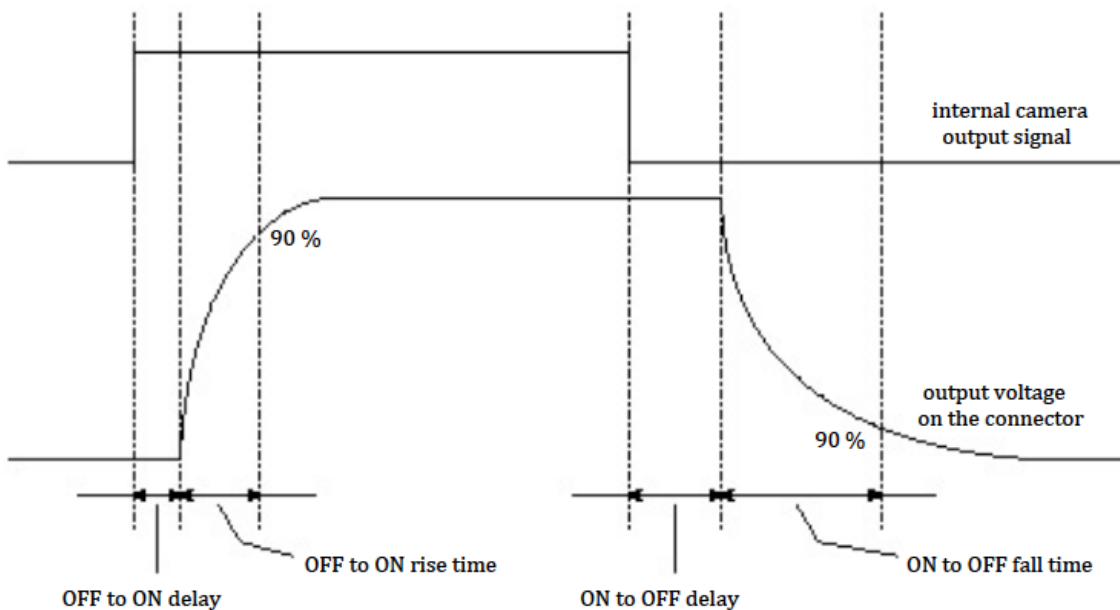

Diagram of the internal optocoupler inputs connections



CORSIGHT output optocoupler timing diagram

Optocoupler outputs

The CORISIGHT camera is equipped with four optically isolated output lines. One output optocoupler is fully independent, the other three are connected with a common collector (Section "I/O connector") due to limited number of pins on the I/O connector.

After power up, the optocoupler outputs are in high impedance state and they remain in that state until reconfigured from the software interface. Whenever the optocoupler output is discon-

nected in the SW interface, it gets in high impedance status.

The optocoupler output's logical state is understood as logical 0 when its output transistor is in high impedance, logical 1 if it is in low impedance mode.

The optocoupler output work with operating voltage range of 5-24 V.

The maximal switched output current is 100 mA per optocoupler, higher current could damage the optocoupler output circuit.

The rising edge (switching to logical 1) propagation time is 750 ns, the falling edge propagation time is under 25 μ s. The exact switching speed may vary with temperature and the used input voltage level — the listed specifications are the worst case values.

Optocoupler output parameters summary

Parameter	Value
Operating voltage	5—24 V
Output current	<100 mA
External resistor requirement	Yes, output current must be limited to 100 mA
OFF to ON delay	750 ns
OFF to ON rise time (10 to 90%)	1.0-4.0 μ s
ON to OFF delay	2.4 – 25 μ s
ON to OFF fall time (90 to 10%)	9.0 – 140 μ s
OFF to ON jitter	\pm 20 ns
ON to OFF jitter	\pm 0.1 μ s

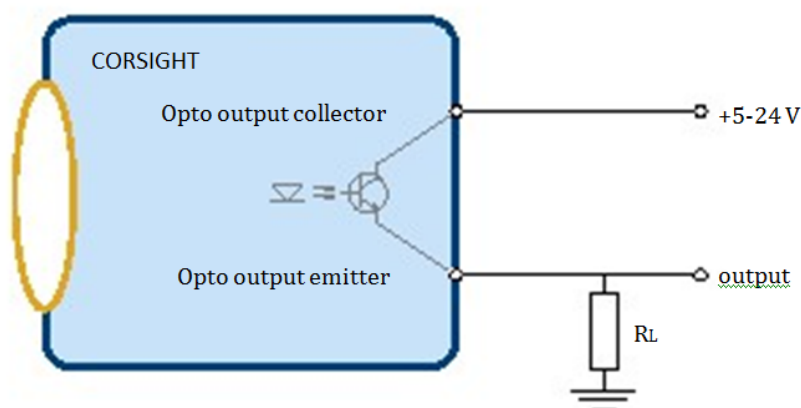

Example of using the optocoupler outputs

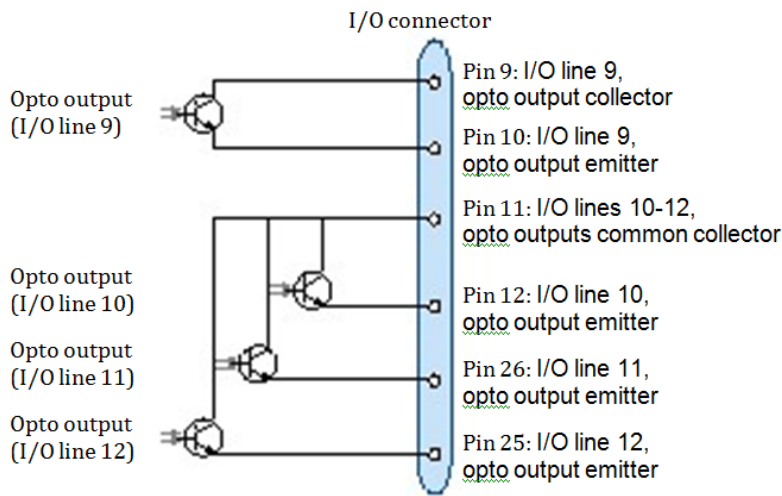
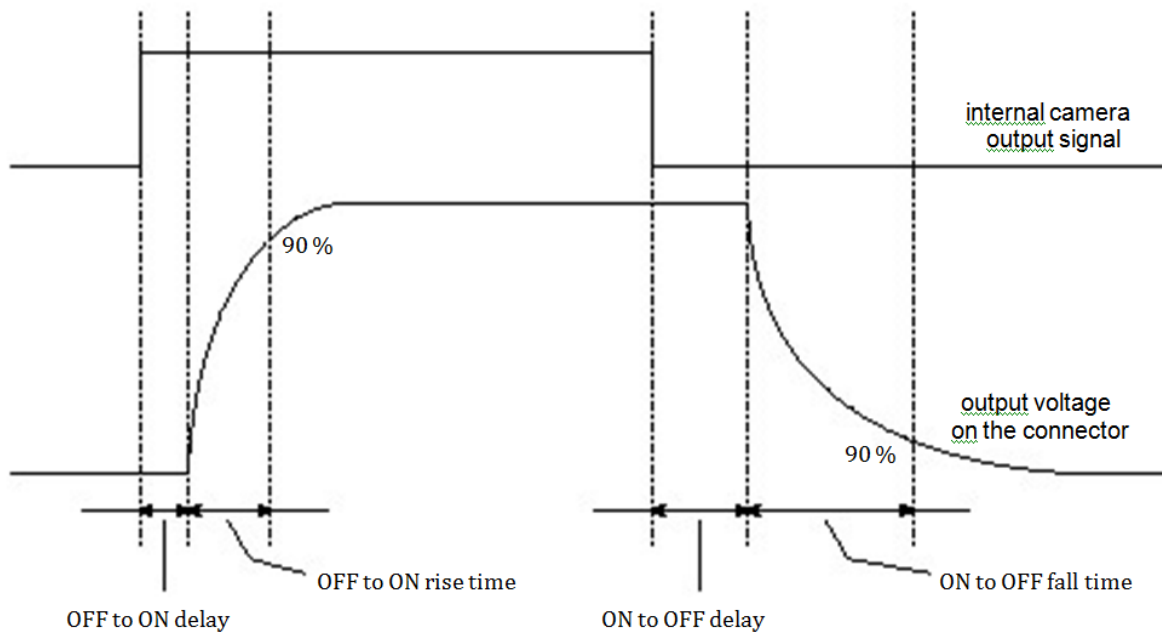

Diagram of the internal optocoupler outputs



CORSIGHT output optocoupler timing diagram

TTL I/O's

Standard 5V TTL (transistor-transistor logic) interface.

After power up, the TTL outputs are driven low — and they remain driven low until reconfigured from the software interface. Whenever the TTL output is disconnected in the SW interface, it gets in driven low status. TTL inputs are pulled up to 5V inside the camera to guarantee a stable input in case nothing is connected. To generate a steep edge the TTL input driver should be capable of driving and sinking 10mA.

The TTL input's and output's logical state is understood as logical 1 when it's driven high (5V) and logical 0 when it's not driven (0V).

The TTL input lines are equipped with a debouncer to prevent generating unwanted input signals.

The delays listed in the table are setup dependent mean values, while the jitters are maximal deviations (\pm) from those mean values.

TTL input/output parameters summary

Parameter	Value
Operating voltage	5V \pm 10% (absolute maximum 6.5V)
ON voltage level	> 3.5 V
OFF voltage level	< 1.5 V
High level output current	-32mA max / high level at 3.8V min
Low level output current	32mA max / low level at 0.55V max
Input to sensor trigger delay	19 μ s (jitter +13/-2 μ s)
TTL-in to TTL-out delay	32 μ s (jitter +10/-2 μ s)

Serial port interface

Standard RS232 communication interface, accessible directly from the camera's feature tree.

Configurable communication parameters are: baud rate, parity, data bits, stop bits.

Connector and cable description

All the grounds from individual connectors are connected inside the camera.

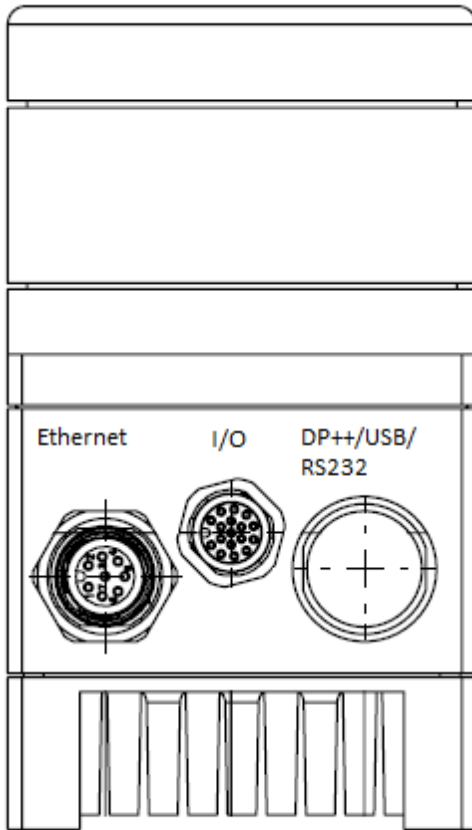

CORSIGHT connectors

I/O connector

17-pin male M12 connector for digital i/o (optocoupler and TTL inputs/outputs) and power input.

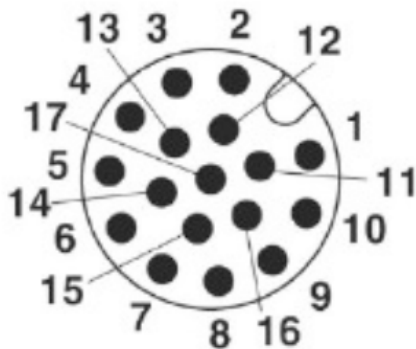

CORSIGHT I/O connector

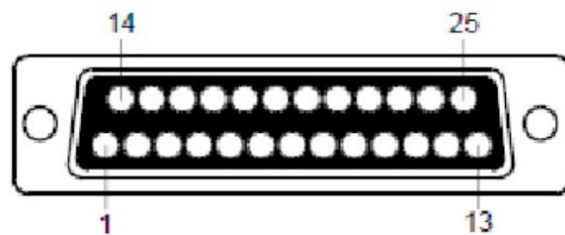

CORSIGHT I/O adapter cable, D-sub 25-pin connector

An adapter cable is available (see Section “[Accessories](#)”), with D-sub 25-pin female interface connector. The table below lists the pinouts also for the connectors of the adapter cable.

I/O connector, pinout (including pin numbers on the D-sub-25 adapter cable)

Pin	Signal	D-Sub 25
1	Power In-	12
2	Power In +	19
3	Optocoupler Input 3 Anode	7
4	Ground	5
5	Optocoupler Output 1-3 Collector	10
6	Optocoupler Output 0 Emitter	9
7	Optocoupler Output 1 Emitter	11
8	Optocoupler Output 3 Emitter	24
9	TTL Input	21
10	TTL Output	20
11	Optocoupler Input 2 Anode	6
12	Optocoupler Input 0 Cathode	2
13	Optocoupler Input 0 Anode	1
14	Optocoupler Output 0 Collector	8
15	Optocoupler Output 2 Emitter	25
16	Optocoupler 1 Input Anode	3
17	Optocoupler 1-3 Input Cathode	4

Pins 13, 14, 15, 16, 17, 18, 22, 23 on the D-sub 25 connector are not connected.

PC system connector

24-pin female M16 connector for DP++, RS232 and USB 2.0.

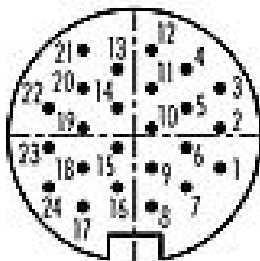

CORSIGHT PC system connector

Adapter cables are available (see Section “[Accessories](#)”), separating individual signal groups into three dedicated connectors: DP++ male, USB Type A female, and RS232 (D-sub 9-pin male). The table below lists the pinouts also for the connectors of the adapter cable.

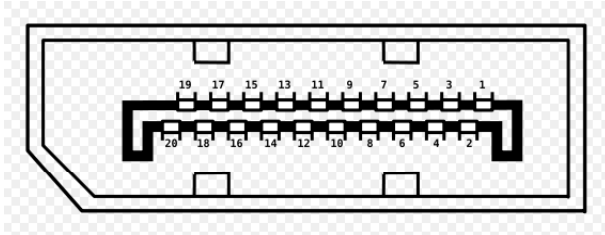

CORSIGHT PC system adapter cable, DP++ connector

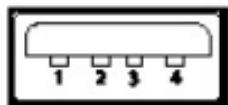

CORSIGHT PC system adapter cable, USB connector



CORSIGHT PC system adapter cable, D-sub 9-pin connectors (RS-232)

PC system connector, pinout (including pin numbers on the DP++/USB/RS232 adapter cable)

M16	Signal	DP	USB	RS-232
1	ML0+	12	---	---
2	ML3-	1	---	---
3	ML2+	6	---	---
4	ML2-	4	---	---
5	ML3+	3	---	---
6	ML0-	10	---	---
7	ML1+	9	---	---
8	ML1-	7	---	---
9	AUX-	17	---	---
10	GND	2,5,8,11,16	---	---
11	Hot Plug	18	---	---
12	+5V	---	---	---
13	+5V	---	---	---
14	GND	---	4	---
15	GND	---	---	---
16	AUX+	15	---	---
17	USB-	---	2	---
18	+5V USB	---	1	---
19	GND	---	---	5
20	RS232_TX	---	---	3
21	CONF1	13	---	---

22	RS232_RX	---	---	2
23	+5V USB	---	---	---
24	USB+	---	3	---
---	Shield	---	---	---

Pins 14, 19, 20 on the DP connector are not connected.

Pins 1, 4, 6, 7, 8, 9 on the RS232 D-sub 9 connector are not connected.

The cable carries following signals via twisted pair wires: ML0+/ML01, ML1+/ML1-, ML2+/ML2-, ML3+/ML3-, AUX+/AUX-, USB-/USB+.

All grounds are connected together.

Ethernet connector

8-pin female M12 Ethernet connector.

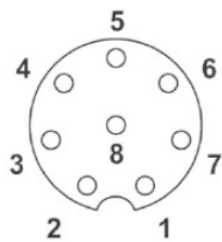

CORSIGHT Ethernet connector

An adapter cable is available (see Section “[Accessories](#)”), with standard Ethernet connector, 8P8C modular plug, often also referred to as RJ-45.

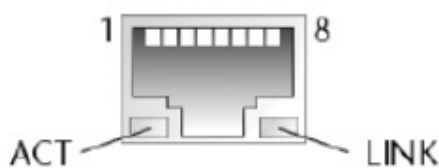

Ethernet RJ-45 connector

CORSIGHT Ethernet connector, pinout

Pin	Signal (1000BASE-T)	Signal (10BASE-T, 100BASE_TX)	Pin RJ-45
1	BI_DC-	NC	5
2	BI_DD+	NC	7
3	BI_DD-	NC	8
4	BI_DA-	TX-	2
5	BI_DB+	RX+	3
6	BI_DA+	TX+	1
7	BI_DC+	NC	4
8	BI_DB-	RX-	6

Status LED

The CORSIGHT cameras are equipped with a set of status LED's. The positions of the LED's on camera's side is shown on the figure below. The purpose of the individual LED's (starting from connector side) is:

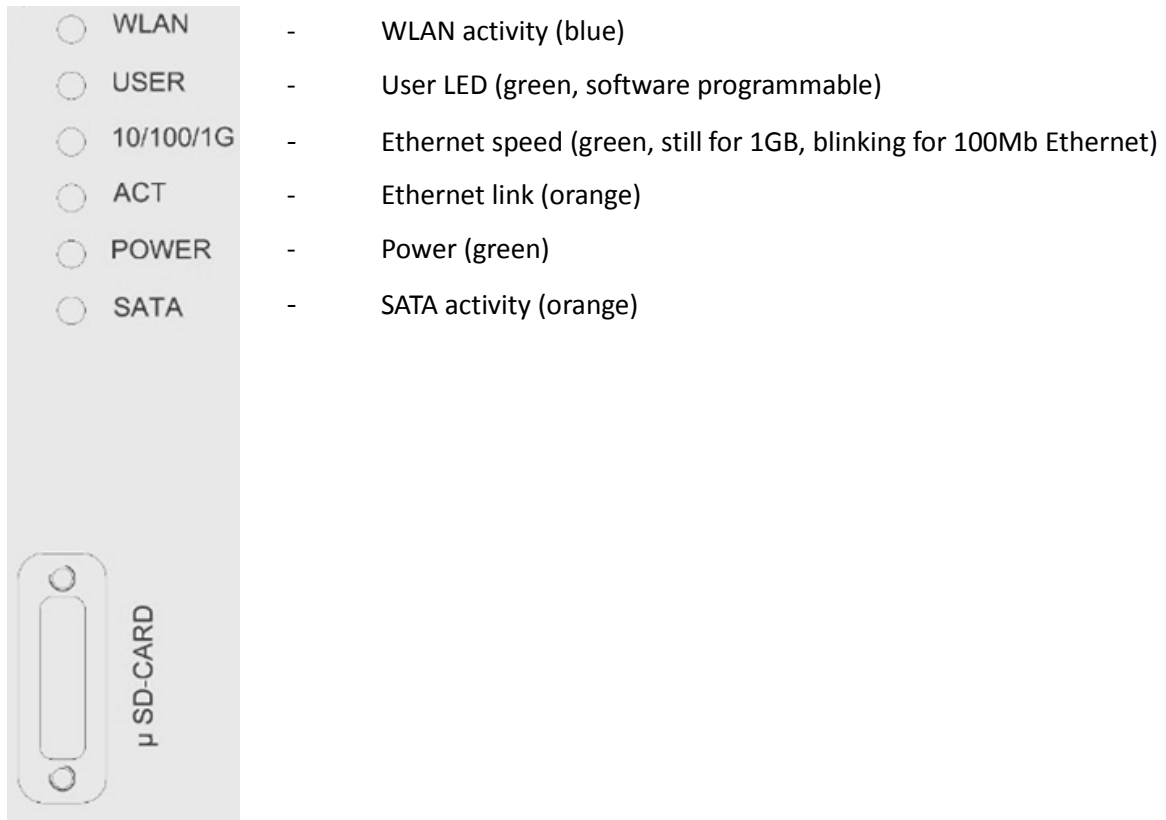

Appendix A. Technical specifications for individual Models

CORSIGHT CO1041C2

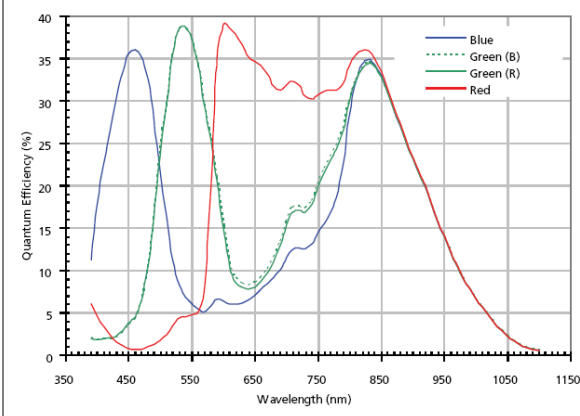
Specification	CORSIGHT CO1041C2
PC technology	Embedded PC with Intel Atom E3845 1.91GHz, 4GB DDR3/1333MHz, 16GB built-in SATA-SSD flashdisk, μ SD card slot, Gigabit Ethernet interface, USB2 interface, DP++ output, 2x WLAN/Bluetooth antenna connector, LUT for image manipulation, MPEG-4/H264 encoder/decoder
Sensor	1/3" CMOS, parallel readout, type Aptina MT9V034
Spectral sensitivity	 <p>The graph displays the quantum efficiency of the sensor across a range of wavelengths from 350 nm to 1150 nm. The y-axis represents Quantum Efficiency (%) from 0 to 40. The x-axis represents Wavelength (nm) from 350 to 1150. Four curves are shown: Blue (solid blue line), Green (B) (dotted green line), Green (R) (solid green line), and Red (solid red line). The Blue curve peaks at approximately 450 nm (~36%). The Green (B) curve peaks at approximately 550 nm (~38%). The Green (R) curve peaks at approximately 650 nm (~38%). The Red curve peaks at approximately 850 nm (~36%).</p>
Monochrome/color resolution (HxV)	Bayer pattern 752 × 480 pixels
Frame rate	62 fps
Video format	10-bit, single tap
Scanning	progressive
Pixel size (HxV)	6 × 6 μ m
Sensor size (HxV)	4.512 × 2.88 mm
Shutter	global, 10–1000 ms (default 15 ms)
trigger modes	Free running, Triggered mode
Gain & black level	Analog gain: 0 .. 12.04 dB (default 12 dB) Digital gain: -12.04 .. 11.48 dB (default 0 dB) Black level: 0 .. 6.35 DN (default 0 DN)
Auto functions	Auto exposure, Automatic analog gain control, Automatic black level
Signal/noise ratio	42 dB
Dynamic range	49 dB
Region of interest (AOI)	Horizontal and vertical ROI applicable directly at the sensor
Binning	- / 2/4 x 2/4
Mount	C-mount (CS-mount on request)
Dimension	65×109×73 mm (W×H×L, without connectors)
Weight	516 g
Power input	24 VDC \pm 10%, 15 W (typical) or PoE+
Digital I/O	4xopto in, 4xopto out, TTL in, TTL out, RS232 interface
Supported operating systems	Microsoft Windows Embedded Standard 7, Linux
Directly supported image processing libraries	Adaptive Vision Studio, Halcon, ActivVisionTools, Common Vision Blox, MATLAB, OpenCV

CORSIGHT CO1041M2

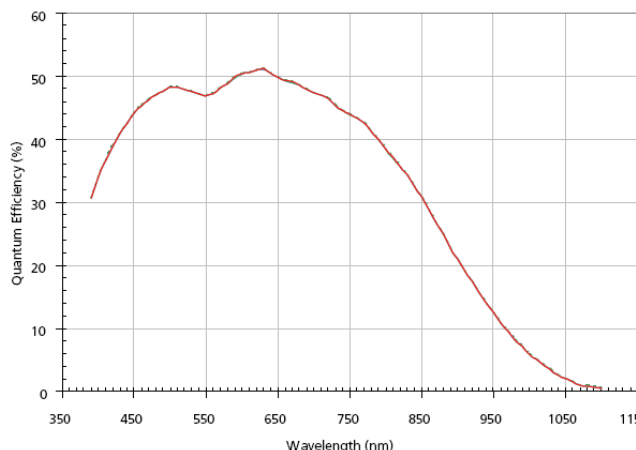
Specification	CORSIGHT CO1041M2
PC technology	Embedded PC with Intel Atom E3845 1.91GHz, up to 4GB DDR3/1333MHz, 16GB built-in SATA-SSD flashdisk, μ SD card slot, Gigabit Ethernet interface, USB2 interface, DP++ output, 2x WLAN/Bluetooth antenna connector, LUT for image manipulation, MPEG-4/H264 encoder/decoder
Sensor	1/3" CMOS, parallel readout, type Aptina MT9V034
Spectral sensitivity	 <p>The graph plots Quantum Efficiency (%) on the y-axis (0 to 60) against Wavelength (nm) on the x-axis (350 to 1150). The efficiency starts at ~30% at 350 nm, rises to a peak of ~50% at 600 nm, and then gradually declines to ~0% at 1100 nm.</p>
Monochrome/color	monochrome
resolution (HxV)	752 x 480 pixels
Frame rate	62 fps
Video format	10-bit, single tap
Scanning	progressive
Pixel size (HxV)	6 x 6 μ m
Sensor size (HxV)	4.512 x 2.88 mm
Shutter	global, 10 –1000 ms (default 15 ms)
trigger modes	Free running, Triggered mode
Gain & black level	Analog gain: 0 .. 12.04 dB (default 12 dB) Digital gain: -12.04 .. 11.48 dB (default 0 dB) Black level: 0 .. 6.35 DN (default 0 DN)
Auto functions	Auto exposure, Automatic analog gain control, Automatic black level
Signal/noise ratio	42 dB
Dynamic range	49 dB
Region of interest (ROI)	Horizontal and vertical ROI applicable directly at the sensor
Binning	Horizontal: 2x 4x, Vertical: 2x 4x
Mount	C-mount (CS-mount on request)
Dimension	65x109x73 mm (WxHxL, without connectors)
Weight	516 g
Power input	24 VDC \pm 10%, 15 W (typical) or PoE+
Digital I/O	4xopto in, 4xopto out, TTL in, TTL out, RS232 interface
Supported operating systems	Microsoft Windows Embedded Standard 7, Linux
Directly supported image processing libraries	Adaptive Vision Studio, Halcon, ActivVisionTools, Common Vision Blox, MATLAB, OpenCV

CORSIGHT CO4136C2

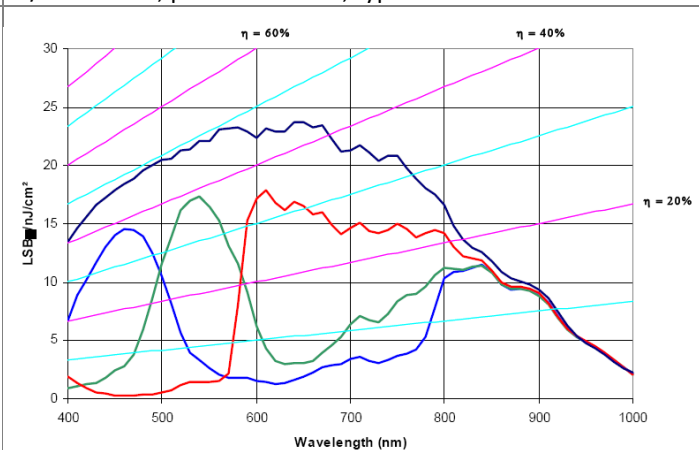
Specification	CORSIGHT CO4136C2
PC technology	Embedded PC with Intel Atom E3845 1.91GHz, 4GB DDR3/1333MHz, 16GB built-in SATA-SSD flashdisk, μ SD card slot, Gigabit Ethernet interface, USB2 interface, DP++ output, 2x WLAN/Bluetooth antenna connector, LUT for image manipulation, MPEG-4/H264 encoder/decoder
Sensor	1/1.8" CMOS, parallel readout, type e2v EV76C560
Spectral sensitivity	
Monochrome/color resolution (HxV)	Bayer pattern 1280 × 1024 pixels
Frame rate	60 fps
Video format	10-bit, single tap
Scanning	progressive
Pixel size (HxV)	5.3 × 5.3 μ m
Sensor size (HxV)	6.784 × 5.4272 mm
Shutter	global, rolling, global reset 16–1000 ms (default 10 ms)
trigger modes	Free running Triggered mode Global reset mode
Gain & black level	Analog gain: 0 .. 18.06 dB (default 0 dB) • Digital gain: 0 .. 24.08 dB (default 0 dB) • Black level: 0 .. 2.55 DN (default 0 DN)
Auto functions	Automatic black level
Region of interest (ROI)	Horizontal and vertical ROI applicable directly at the sensor
Binning	Horizontal: 2x, Vertical: 2x
Mount	C-mount (CS-mount on request)
Dimension	65×109×73 mm (W×H×L, without connectors)
Weight	516 g
Power input	24 VDC \pm 10%, 15 W (typical) or PoE+
Digital I/O	4xopto in, 4xopto out, TTL in, TTL out, RS232 interface
Supported operating systems	Microsoft Windows Embedded Standard 7, Linux
Directly supported image processing libraries	Adaptive Vision Studio, Halcon, ActivVisionTools, Common Vision Blox, MATLAB, OpenCV

CORSIGHT CO4136M2

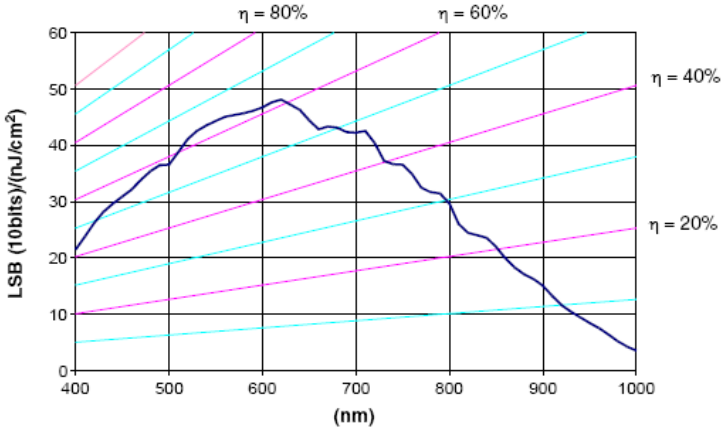
Specification	CORSIGHT CO4136M2
PC technology	Embedded PC with Intel Atom E3845 1.91GHz, 4GB DDR3/1333MHz, 16GB built-in SATA-SSD flashdisk, μ SD card slot, Gigabit Ethernet interface, USB2 interface, DP++ output, 2x WLAN/Bluetooth antenna connector, LUT for image manipulation, MPEG-4/H264 encoder/decoder
Sensor	1/1.8" CMOS, parallel readout, type e2v EV76C560
Spectral sensitivity	 <p>The graph plots Spectral Sensitivity (LSB (10bits)/(μJ/cm²)) on the y-axis (0 to 60) against Wavelength (nm) on the x-axis (400 to 1000). Four curves represent different quantum efficiencies (η): 80% (top), 60%, 40%, and 20% (bottom). The 80% curve peaks at approximately 48 LSB/(μJ/cm²) around 600 nm. The 20% curve peaks at approximately 10 LSB/(μJ/cm²) around 600 nm.</p>
Monochrome/color	monochrome
resolution (H×V)	1280 × 1024 pixels
Frame rate	60 fps
Video format	10-bit, single tap
Scanning	progressive
Pixel size (H×V)	5.3 × 5.3 μm
Sensor size (H×V)	6.784 × 5.4272 mm
Shutter	global, rolling, global reset 16–1000 ms (default 10 ms)
trigger modes	Free running, Triggered mode, Global reset mode
Gain & black level	Analog gain: 0 .. 18.06 dB (default 0 dB) <ul style="list-style-type: none"> • Digital gain: 0 .. 24.08 dB (default 0 dB) • Black level: 0 .. 2.55 DN (default 0 DN)
Auto functions	Automatic black level
Region of interest (ROI)	Horizontal and vertical ROI applicable directly at the sensor
Binning	Horizontal: 2× Vertical: 2×
Mount	C-mount (CS-mount on request)
Dimension	65×109×73 mm (W×H×L, without connectors)
Weight	516 g
Power input	24 VDC ±10%, 15 W (typical) or PoE+
Digital I/O	4×opto in, 4×opto out, TTL in, TTL out, RS232 interface
Supported operating systems	Microsoft Windows Embedded Standard 7, Linux
Directly supported image processing libraries	Adaptive Vision Studio, Halcon, ActivVisionTools, Common Vision Blox, MATLAB, OpenCV

CORSIGHT CO4136IR2

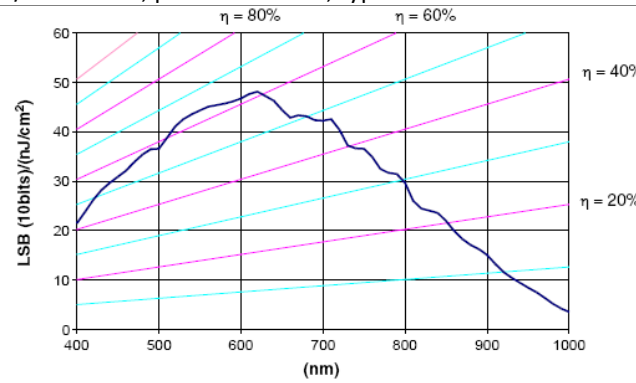
Specification	CORSIGHT CO4136IR2
PC technology	Embedded PC with Intel Atom E3845 1.91GHz, 4GB DDR3/1333MHz, 16GB built-in SATA-SSD flashdisk, μ SD card slot, Gigabit Ethernet interface, USB2 interface, DP++ output, 2x WLAN/Bluetooth antenna connector, LUT for image manipulation, MPEG-4/H264 encoder/decoder
Sensor	1/1.8" CMOS, parallel readout, type e2v EV76C661
Spectral sensitivity	 <p>The graph plots Spectral Sensitivity (LSB (10bits)/(nJ/cm²)) on the y-axis (0 to 60) against Wavelength (nm) on the x-axis (400 to 1000). Four curves represent different quantum efficiencies (eta): 80% (blue), 60% (magenta), 40% (cyan), and 20% (red). The 80% curve peaks at approximately 48 LSB/(nJ/cm²) around 650 nm. The 60% curve peaks at approximately 42 LSB/(nJ/cm²) around 650 nm. The 40% curve peaks at approximately 35 LSB/(nJ/cm²) around 650 nm. The 20% curve peaks at approximately 25 LSB/(nJ/cm²) around 650 nm.</p>
Monochrome/color	Monochrome
resolution (HxV)	1280 x 1024 pixels
Frame rate	60 fps
Video format	10-bit, single tap
Scanning	Progressive
Pixel size (HxV)	5.3 x 5.3 μ m
Sensor size (HxV)	6.784 x 5.4272 mm
Shutter	global, rolling, global reset 16–1000 ms (default 10 ms)
trigger modes	Free running, Triggered mode, Global reset mode
Gain & black level	Analog gain: 0 .. 18.06 dB (default 0 dB) <ul style="list-style-type: none"> Digital gain: 0 .. 24.08 dB (default 0 dB) Black level: 0 .. 2.55 DN (default 0 DN)
Auto functions	Automatic black level
Region of interest (ROI)	Horizontal and vertical ROI applicable directly at the sensor
Binning	Horizontal: 2x Vertical: 2x
Mount	C-mount (CS-mount on request)
Dimension	65x109x73 mm (WxHxL, without connectors)
Weight	516 g
Power input	24 VDC \pm 10%, 15 W (typical) or PoE+
Digital I/O	4xopto in, 4xopto out, TTL in, TTL out, RS232 interface
Supported operating systems	Microsoft Windows Embedded Standard 7, Linux
Directly supported image processing libraries	Adaptive Vision Studio, Halcon, ActivVisionTools, Common Vision Blox, MATLAB, OpenCV

CORSIGHT CO4206C2

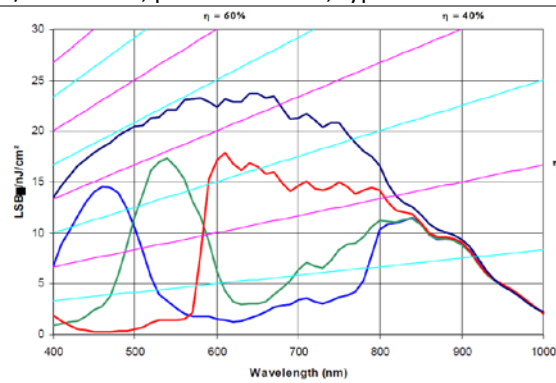
Specification	CORSIGHT CO4206C2
PC technology	Embedded PC with Intel Atom E3845 1.91GHz, 4GB DDR3/1333MHz, 16GB built-in SATA-SSD flashdisk, μ SD card slot, Gigabit Ethernet interface, USB2 interface, DP++ output, 2x WLAN/Bluetooth antenna connector, LUT for image manipulation, MPEG-4/H264 encoder/decoder
Sensor	1/1.8" CMOS, parallel readout, type e2v EV76C570
Spectral sensitivity	
Monochrome/color	Bayer pattern
resolution (H×V)	1600 x 1200 pixels
Frame rate	50
Video format	10-bit, single tap
Scanning	progressive
Pixel size (H×V)	4.5 × 4.5 μ m
Sensor size (H×V)	7.200 × 5.400 mm
Shutter	global, rolling, global reset 31–1030 ms (default 10 ms)
trigger modes	Free running, Triggered mode, Global reset mode
Gain & black level	Analog gain: 0 .. 18.06 dB (default 0 dB) <ul style="list-style-type: none"> Digital gain: 0 .. 24.08 dB (default 0 dB) Black level: 0 .. 2.55 DN (default 0 DN)
Auto functions	Automatic black level
Region of interest (ROI)	Horizontal and vertical ROI applicable directly at the sensor
Binning	Horizontal: 2× Vertical: 2×
Mount	C-mount (CS-mount on request)
Dimension	65×109×73 mm (W×H×L, without connectors)
Weight	516 g
Power input	24 VDC \pm 10%, 15 W (typical) or PoE+
Digital I/O	4×opto in, 4×opto out, TTL in, TTL out, RS232 interface
Supported operating systems	Microsoft Windows Embedded Standard 7, Linux
Directly supported image processing libraries	Adaptive Vision Studio, Halcon, ActivVisionTools, Common Vision Blox, MATLAB, OpenCV

CORSIGHT CO4206M2

Specification	CORSIGHT CO4206M2
PC technology	Embedded PC with Intel Atom E3845 1.91GHz, 4GB DDR3/1333MHz, 16GB built-in SATA-SSD flashdisk, μ SD card slot, Gigabit Ethernet interface, USB2 interface, DP++ output, 2x WLAN/Bluetooth antenna connector, LUT for image manipulation, MPEG-4/H264 encoder/decoder
Sensor	1/1.8" CMOS, parallel readout, type e2v EV76C570
Spectral sensitivity	
Monochrome/color	monochrome
resolution (H×V)	1600 x 1200 pixels
Frame rate	50
Video format	10-bit, single tap
Scanning	progressive
Pixel size (H×V)	4.5 × 4.5 μ m
Sensor size (H×V)	7.200 × 5.400 mm
Shutter	global, rolling, global reset 31–1030 ms (default 10 ms)
trigger modes	Free running, Triggered mode, Global reset mode
Gain & black level	Analog gain: 0 .. 18.06 dB (default 0 dB) <ul style="list-style-type: none"> Digital gain: 0 .. 24.08 dB (default 0 dB) Black level: 0 .. 2.55 DN (default 0 DN)
Auto functions	Automatic black level
Region of interest (ROI)	Horizontal and vertical ROI applicable directly at the sensor
Binning	Horizontal: 2x Vertical: 2x
Mount	C-mount (CS-mount on request)
Dimension	65×109×73 mm (W×H×L, without connectors)
Weight	516 g
Power input	24 VDC \pm 10%, 15 W (typical) or PoE+
Digital I/O	4xopto in, 4xopto out, TTL in, TTL out, RS232 interface
Supported operating systems	Microsoft Windows Embedded Standard 7, Linux
Directly supported image processing libraries	Adaptive Vision Studio, Halcon, ActivVisionTools, Common Vision Blox, MATLAB, OpenCV

CORSIGHT CO1503C2

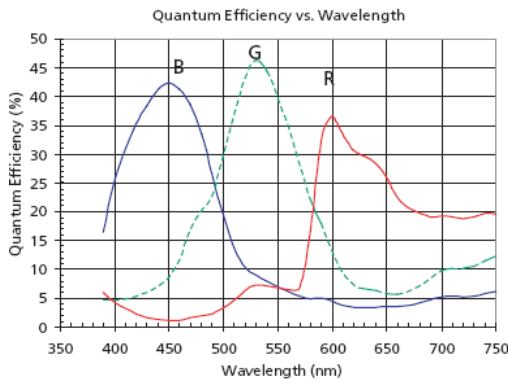
Specification	CORSIGHT CO1503C2
PC technology	Embedded PC with Intel Atom E3845 1.91GHz, 4GB DDR3/1333MHz, 16GB built-in SATA-SSD flashdisk, μ SD card slot, Gigabit Ethernet interface, USB2 interface, DP++ output, 2x WLAN/Bluetooth antenna connector, LUT for image manipulation, MPEG-4/H264 encoder/decoder
Sensor	1/2.5" CMOS, sequential readout, type Aptina MT9P031
Spectral sensitivity	 <p>The graph shows Quantum Efficiency (%) on the y-axis (0 to 50) versus Wavelength (nm) on the x-axis (350 to 750). Three curves are plotted: Blue (B), Green (G), and Red (R). The Blue curve peaks at approximately 45% around 450 nm. The Green curve peaks at approximately 45% around 520 nm. The Red curve peaks at approximately 35% around 600 nm.</p>
Monochrome/color	Bayer pattern
resolution (HxV)	2592 x 1944 pixels
Frame rate	14 fps
Video format	12-bit, single tap
Scanning	progressive
Pixel size (HxV)	2.2 x 2.2 μ m
Sensor size (HxV)	5.702 x 4.277 mm
Shutter	rolling, 39–55000 ms (default 10 ms)
trigger modes	Free running, Triggered mode, Global reset mode
Gain & black level	Analog gain: 0 .. 18.06 dB (default 0 dB) // Digital gain: 0 .. 24.08 dB (default 0 dB) // Black level: 0 .. 2.55 DN (default 0 DN)
Auto functions	Automatic black level
Signal/noise ratio	38 dB
Dynamic range	70 dB
Region of interest (ROI)	Vertical ROI applicable directly at the sensor
Binning	Horizontal: 2x 4x, Vertical: 2x 4x
Decimation	Horizontal: 2x 3x 4x 5x 6x 7x Vertical: 2x 3x 4x 5x 6x 7x 8x
Mount	C-mount (CS-mount on request)
Dimension	65x109x73 mm (WxHxL, without connectors)
Weight	500 g
Power input	24 VDC \pm 10%, 15 W (typical) or PoE+
Digital I/O	4xopto in, 4xopto out, TTL in, TTL out, RS232 interface
Supported operating systems	Microsoft Windows Embedded Standard 7, Linux
Directly supported image processing libraries	Adaptive Vision Studio, Halcon, ActivVisionTools, Common Vision Blox, MATLAB, OpenCV

CORSIGHT CO1503M2

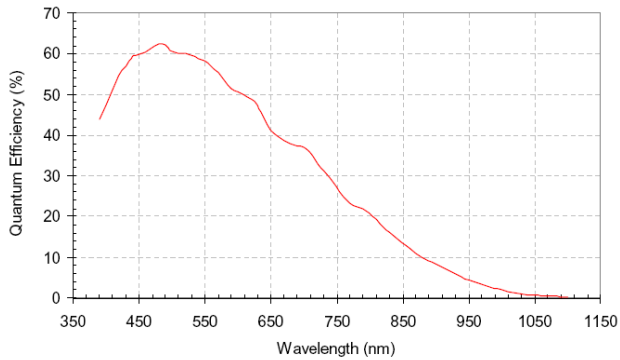
Specification	CORSIGHT CO1503M2
PC technology	Embedded PC with Intel Atom E3845 1.91GHz, 4GB DDR3/1333MHz, up to 16GB built-in SATA-SSD flashdisk, μ SD card slot, Gigabit Ethernet interface, USB2 interface, DP++ output, 2x WLAN/Bluetooth antenna connector, LUT for image manipulation, MPEG-4/H264 encoder/decoder
Sensor	1/2.5" CMOS, sequential readout, type Aptina MT9P031
Spectral sensitivity	 <p>The graph plots Quantum Efficiency (%) on the y-axis (0 to 70) against Wavelength (nm) on the x-axis (350 to 1150). The efficiency starts at ~45% at 350 nm, rises to a peak of ~60% at 500 nm, then gradually declines to ~40% at 650 nm, ~25% at 750 nm, and reaches near 0% by 1150 nm.</p>
Monochrome/color	monochrome
resolution (HxV)	2592 x 1944 pixels
Frame rate	11.7 fps
Video format	12-bit, single tap
Scanning	progressive
Pixel size (HxV)	2.2 x 2.2 μ m
Sensor size (HxV)	5.702 x 4.277 mm
Shutter	rolling, 39–55000 ms (default 10 ms)
trigger modes	Free running, Triggered mode, Global reset mode
Gain & black level	Analog gain: 0 .. 18.06 dB (default 0 dB) Digital gain: 0 .. 24.08 dB (default 0 dB) Black level: 0 .. 2.55 DN (default 0 DN)
Auto functions	Automatic black level
Signal/noise ratio	38 dB
Dynamic range	70 dB
Region of interest (ROI)	Vertical ROI applicable directly at the sensor
Binning	Horizontal: 2x 4x, Vertical: 2x 4x
Decimation	Horizontal: 2x 3x 4x 5x 6x 7x Vertical: 2x 3x 4x 5x 6x 7x 8x
Mount	C-mount (CS-mount on request)
Dimension	65x109x73 mm (WxHxL, without connectors)
Weight	516 g
Power input	24 VDC \pm 10%, 15 W (typical) or PoE+
Digital I/O	4xopto in, 4xopto out, TTL in, TTL out, RS232 interface
Supported operating systems	Microsoft Windows Embedded Standard 7, Linux
Directly supported image processing libraries	Adaptive Vision Studio, Halcon, ActivVisionTools, Common Vision Blox, MATLAB, OpenCV

CORSIGHT COL6270M2 /COL6435M2

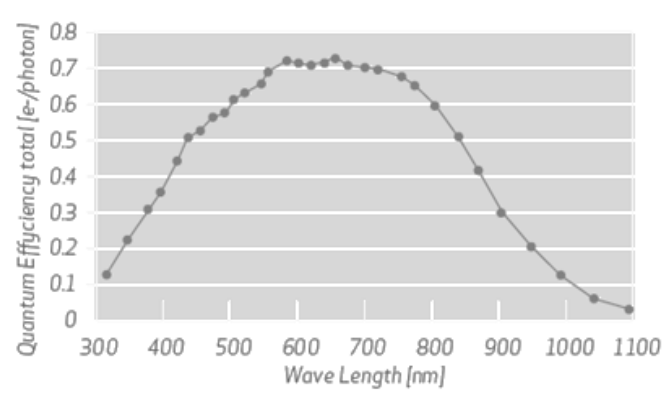
Specification	COL6270M2	COL 6435M2																																				
PC technology	Embedded PC with Intel Atom E3845 1.91GHz, 4GB DDR3/1333MHz, 16GB built-in SATA-SSD flashdisk, μ SD card slot, Gigabit Ethernet interface, USB2 interface, DP++ output, 2x WLAN/Bluetooth antenna connector, LUT for image manipulation, MPEG-4/H264 encoder/decoder																																					
Sensor	Dragster 2k7	4k3.5																																				
Spectral sensitivity	 <table border="1"> <caption>Approximate data points from the Quantum Efficiency graph</caption> <thead> <tr> <th>Wave Length [nm]</th> <th>Quantum Efficiency total [e-/photon]</th> </tr> </thead> <tbody> <tr><td>300</td><td>0.12</td></tr> <tr><td>350</td><td>0.22</td></tr> <tr><td>400</td><td>0.35</td></tr> <tr><td>450</td><td>0.50</td></tr> <tr><td>500</td><td>0.60</td></tr> <tr><td>550</td><td>0.68</td></tr> <tr><td>600</td><td>0.72</td></tr> <tr><td>650</td><td>0.75</td></tr> <tr><td>700</td><td>0.72</td></tr> <tr><td>750</td><td>0.68</td></tr> <tr><td>800</td><td>0.55</td></tr> <tr><td>850</td><td>0.35</td></tr> <tr><td>900</td><td>0.20</td></tr> <tr><td>950</td><td>0.10</td></tr> <tr><td>1000</td><td>0.05</td></tr> <tr><td>1050</td><td>0.02</td></tr> <tr><td>1100</td><td>0.01</td></tr> </tbody> </table>		Wave Length [nm]	Quantum Efficiency total [e-/photon]	300	0.12	350	0.22	400	0.35	450	0.50	500	0.60	550	0.68	600	0.72	650	0.75	700	0.72	750	0.68	800	0.55	850	0.35	900	0.20	950	0.10	1000	0.05	1050	0.02	1100	0.01
Wave Length [nm]	Quantum Efficiency total [e-/photon]																																					
300	0.12																																					
350	0.22																																					
400	0.35																																					
450	0.50																																					
500	0.60																																					
550	0.68																																					
600	0.72																																					
650	0.75																																					
700	0.72																																					
750	0.68																																					
800	0.55																																					
850	0.35																																					
900	0.20																																					
950	0.10																																					
1000	0.05																																					
1050	0.02																																					
1100	0.01																																					
Monochrome/color	monochrome																																					
Number of pixels	2048	4096																																				
Pixel size [μm]	7.00 \times 7.00 μ m	3.50 \times 3.50 μ m																																				
Video format	12-bit, single tap																																					
Sensor length	14.33 mm																																					
Line scan rate [kHz]	37	18.5																																				
Flat field correction	Yes																																					
Exposure control	Yes																																					
Auto functions	Automatic black level																																					
Trigger modes	free running, triggered model																																					
Gain & black level	analog gain (0...12 dB), digital gain (-6...20 dB)																																					
Mount	C-mount (CS-mount on request)																																					
Dimension	65 \times 109 \times 73 mm (W \times H \times L, without connectors)																																					
Weight	516 g																																					
Power input	24 VDC \pm 10%, 15 W (typical) or PoE+																																					
Digital I/O	4 \times opto in, 4 \times opto out, TTL in, TTL out, RS-232 interface																																					
Supported operating systems	Microsoft Windows Embedded Standard 7, Linux																																					
Directly supported image processing libraries	Adaptive Vision Studio, Halcon, ActivVisionTools, Common Vision Blox, MATLAB, OpenCV																																					

Technical Support

NET ensures the conformity of its product to be reliable and free from defects during manufacturing by testing all the cameras before release. However, unexpected problems and technical issues may come up due to the complexity of the product.

In case you require technical support, contact the agent near you or contact NET directly at the following locations:

Websites

Europe	www.net-gmbh.com
Italy	www.net-italia.it
USA	www.net-usa-inc.com
Asia	www.net-japan.com

Email

Europe	info@net-gmbh.com
Italy	info@net-italia.it
USA	info@net-usa-inc.com
Asia	info@net-japan.com

Phone

Europe	+49 8806 92 34-0
Italy	+39 305 237 163
USA	+1 219 934 9042
Asia	+81 454 781 020

Fax

Europe	+49 8806 92 34-77
Italy	+39 305 237 163
USA	+1 219 934 9047
Asia	+81 45 476 2423

In case of an RMA, you must first contact NET and obtain an RMA Number before sending the product to us. We are not responsible for any problems caused by not following the RMA procedure.

Imprint

NET New Electronic Technology GmbH

Address:

Lerchenberg 7
D-86923 Finning
Germany

Contact:

Phone: +49-88 06-92 34-0
Fax: +49-88 06-92 34-77
www.net-gmbh.com
E-mail: info@net-gmbh.com

VAT- ID: DE 811948278
Register Court: Augsburg HRB 18494

Copyright © 2016 NEW ELECTRONIC TECHNOLOGY GMBH

All rights reserved.