



**FireFly Green**

# FireFly Green

The FireFly Green range sets a new standard for industrial grade, green laser diode modules. A radically new design provides TE stabilised performance without TE cost and power consumption.

It is a self-contained laser that offers the user increased stability over a wide operating temperature and with a faster warm up time.

The in-built Laser Intelligent Control (LIC) electronics provide stable continuous wave or linear (analogue) or TTL (digital) modulated operation with automatic power control (APC), reverse polarity protection and over temperature protection. The LIC ensures a high level of reliability over time and temperature. The laser operates from a low voltage input 5 Vdc and a low operating current of 555mA (Max).

The diode pumped solid state laser produces a circular beam with low divergence and an output wavelength of 532nm with powers up to 50mW. For applications that demand reduced noise such as scanning and projection, a lower noise version is available that has a RMS noise of <1%.

Accurate bore sight alignment of the beam is achieved optically in a lens system that produces a high quality spot over a wide range of distances. The laser has a range of internal driver boards that provide either CW operation, analogue control or TTL level pulse width modulation.

Supplementary lenses are available to convert the spot to a line or a cross. The lines of the cross can be adjusted to be at exactly 90°, even when the laser is mounted at any angle to the surface.



# FireFly



## Key Features:-

- Stable power without thermoelectric (TE) Cooling
- Wide operating temperature range
- Powers up to 50mW
- Linear Control or Pulsed TTL Level Control from DC to 50KHz
- Power stability better than  $\pm 5\%$  over full operating temperature range
- Reverse polarity protected

# Accessories

## Heavy Duty Mounting Clamp

The optional heavy duty mounting clamp allows the FireFly range to be securely fixed at any required direction or angle. The base plate has a series of threaded holes which allows the clamp to be fixed directly onto a machine or workbench.

## Magnetic Mount

A magnetic base is also available which allows the heavy duty clamp to be magnetically attached to a ferrous surface, negating the need for any mounting holes.

## Line & Cross Optics

Optical elements are available as accessories that convert the spot to a line or a variable intersection angle cross. The lines of the cross can be adjusted to be at exactly  $90^\circ$ , even when the laser is mounted at an angle to the surface. There are 5 options available:-

- Cross Lens Optic  $55^\circ$
- Long Line Optic  $55^\circ$
- Extra Long Line Optics  $90^\circ$
- Short Line Optic  $30^\circ$
- Long Line + Dot Optic

The optics are designed to be screwed into the front of the FireFly barrel.



# Power Stability

The profiles below show the typical power stability vs. time and power stability vs. temperature.

**Typical Power Stability vs. Time**

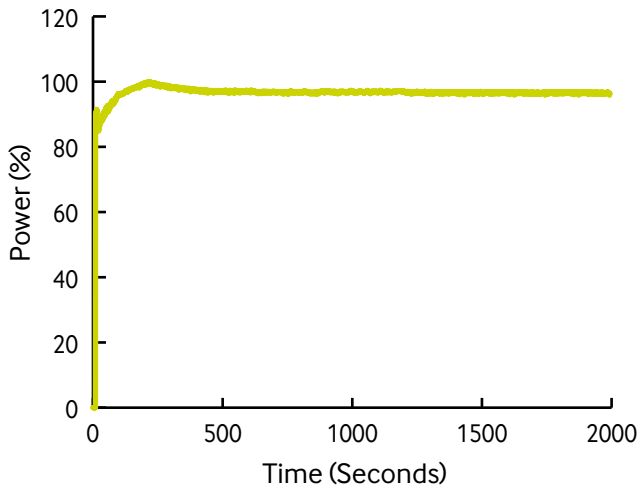

**Typical Power Stability vs. Temperature**

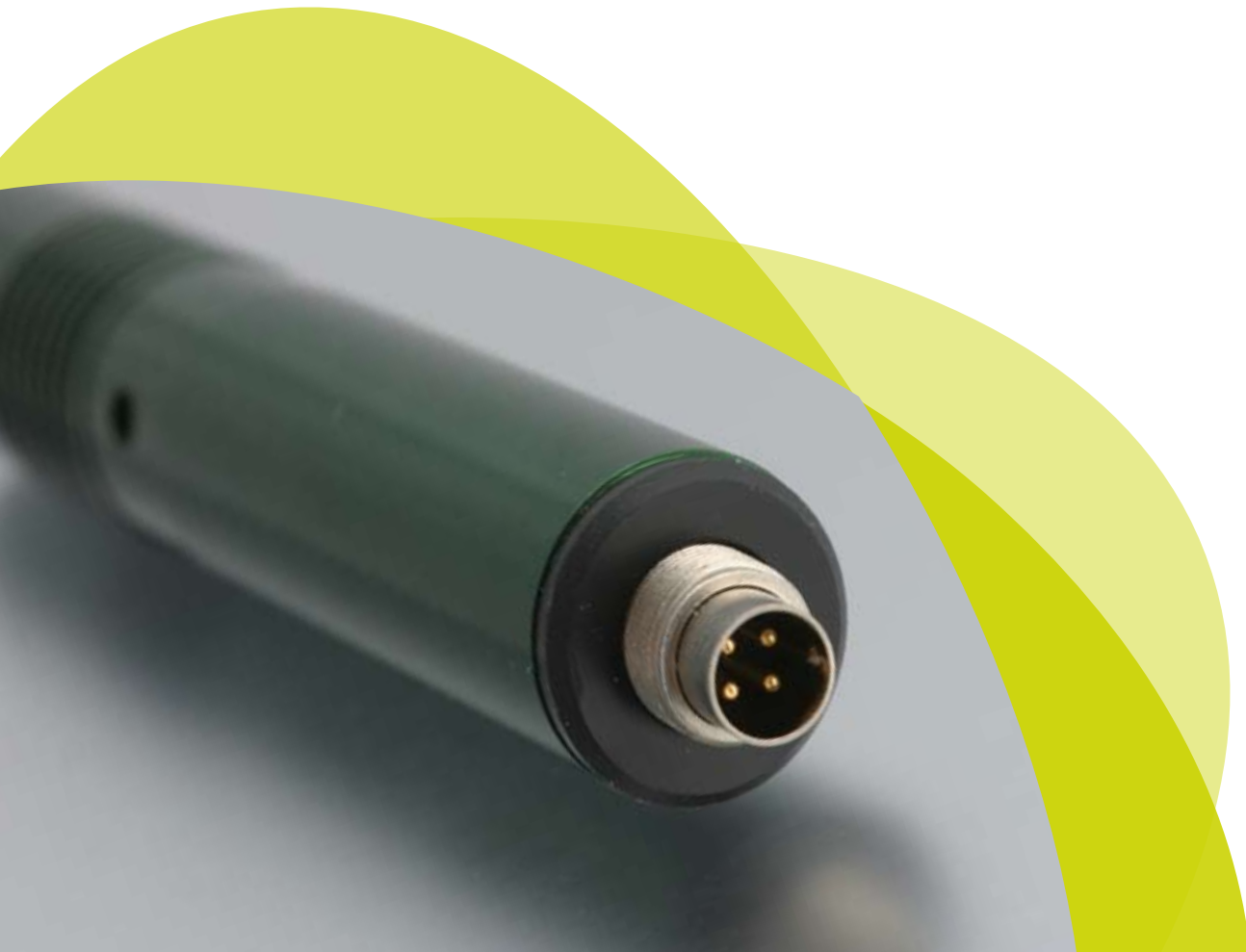
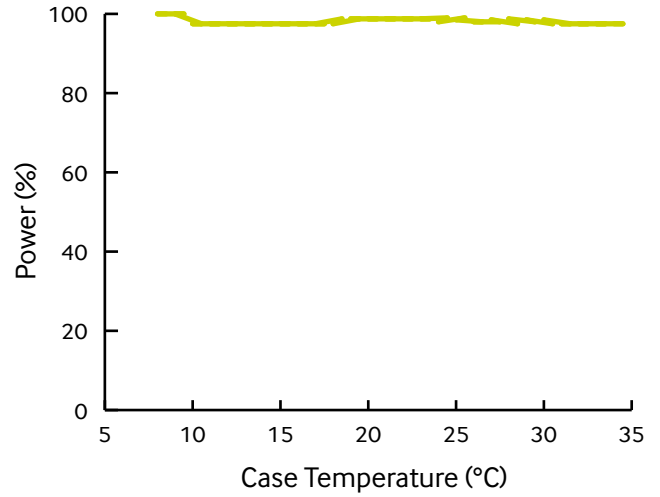

# Focusing Characteristics

The following charts show the typical focusing of the FireFly laser. The focus charts indicate the minimum spot size (at  $1/e^2$ ) achievable for a specific projection distance.

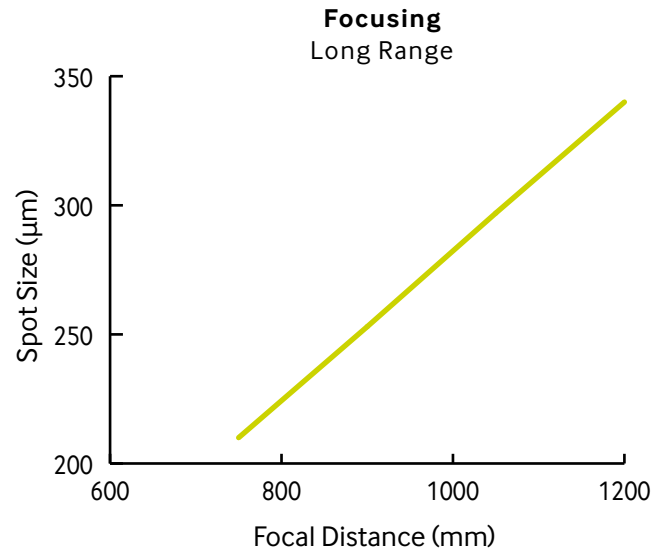
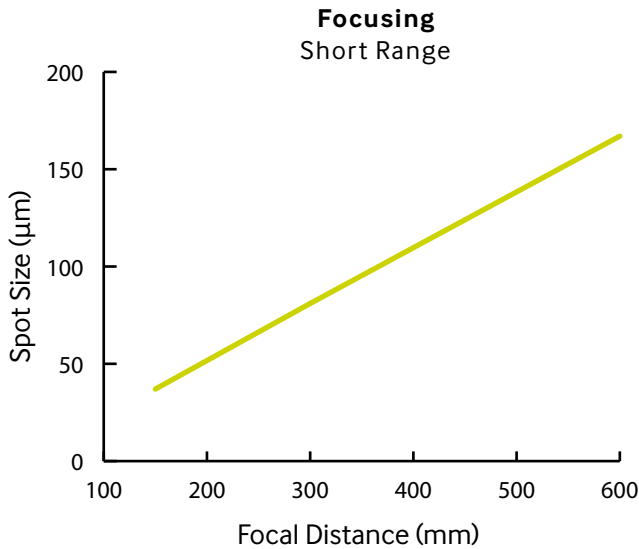

# Depth of Field Characteristics

The following charts show the typical depth-of-field performance of the FireFly laser. The depth-of-field is defined as the distance between two points either side of the pre-set focus at which the spot size increases by a factor of  $\sqrt{2}$ .

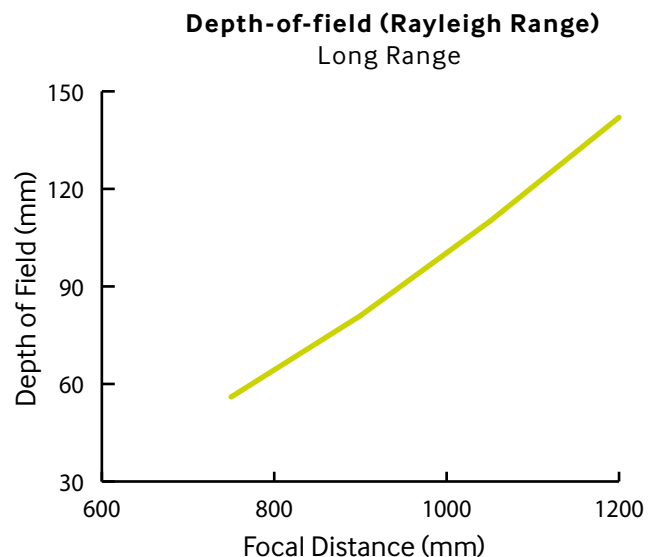
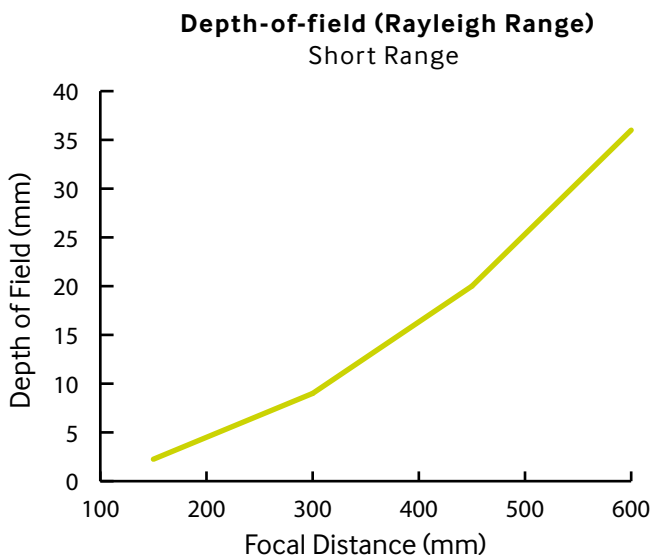

# Specifications

	Firefly	Firefly-RN
<b>Mechanical Information</b>		
Mass (grams)	39	
Dimensions (mm)	17 x 94 (not including connector)	
Housing	Green Anodised Aluminium	
Isolated Body	Yes	
Input Leads	CW Version - 250mm Cable 2 wires, Red (+ve) Black (0V)	
	Modulated Version - 500mm Cable 4 wires, Red (+ve) Black (0V) Yellow (Modulation) Blue (Enable)	
<b>Optical Information</b>		
Diode Power (mW)	5, 10, 20, 35, 50 (Custom powers available upon request)	
Wavelength (nm)	532	
Intensity Distribution	TEM <sub>00</sub>	
Focus Range (mm)	125 to infinity (300 with line or cross optics)	
Warm Up Time to 75% of Full Power	< 30 seconds	
Power Stability Over Operating Range	<±5%	
Power Stability Over Constant Temperature	< 1%	
Noise (RMS, 20Hz - 20MHz)	n/a	<1%
Beam Size At Aperture (mm)	3	
Minimum Beam Divergence (mrad)	0.1	
Pointing Stability (mrad)	0.02	
M <sup>2</sup>	<1.2	
Focus	User Adjustable	
Bore Sighting (mrad)	<2	
<b>Environmental Information</b>		
Operating Case Temperature (°C)	+5 to +35*	
Storage Temperature (°C)	-10 to +85	
Operating Humidity (%RH)	90 (non condensing)	
MTTF @ 25°C (hrs)	5mW = >10,000 10/20mW = >7,000 35/50mW = >5,000	
<b>Electrical Specifications</b>		
Input Voltage	3.3Vdc to 5Vdc	
Operating Current (mA)	555 max (Diode Dependant)	
Connector Type	CW Version - Flying Leads	
	Modulated Version - Binder Connector	
Reverse Polarity Protection	Yes	
Over Temperature Protection	Yes	
NOTES * Suitable heatsink recommended for use with powers above 10mW All specifications are typical @ 25°C		

# Standard Driver Types

Two driver boards are available for the FireFly laser, either Linear (LC) or TTL control (PWM).

## Linear Intensity & Analogue Modulation Control (LC)

### User Adjustable Intensity Control

Using the yellow control lead output power intensity may be linearly controlled from zero to the maximum factory set value. This may be achieved using a simple resistor or by applying a control voltage between 0 and 1V where 0Vdc is off and +1Vdc is maximum power, with a linear relationship for every value between. *See chart below.*

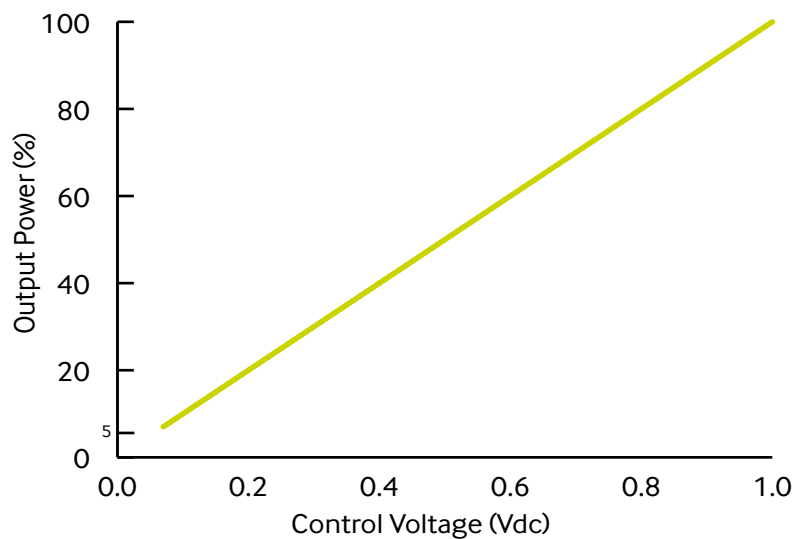

## Modulation & Synchronization

Using the yellow control lead the laser may be modulated or synchronised by using an external signal. The required voltage range is 0 to +1 Vdc (to set the maximum intensity), frequency range is DC to 50KHz. Please note: applying more than 1 V does not increase the power above maximum but it can reduce the maximum frequency of modulation.

*Note: Intensity control and modulation functions may be used together.*

## Pulse Width Modulation TTL Digital Control (PWM)

The FireFly laser is also available with a TTL driver board that allows the unit to be gated on and off, or pulse-width modulated at TTL voltage levels via the yellow control lead. The standard version offers non inverting TTL where an input signal of TTL Low = off and TTL High = on and vice versa for the inverted model. Frequency bandwidth is typically 50 kHz.

Rise Time: < 10us (typical)

Fall Time: < 10us (typical)

## 4th Pin - Enable Function

The 4th pin enable function is also responsive to TTL voltage levels and functions as an electronic switch to quickly turn the laser on and off without the need to disturb the power supply. A TTL level high turns the laser on and a TTL level low turns the laser off. The bandwidth is typically 1kHz.

# Laser Safety

Our lasers are compliant to IEC 60825-1 2007 standards. The lasers fall within one of the following classifications depending on power and wavelength.

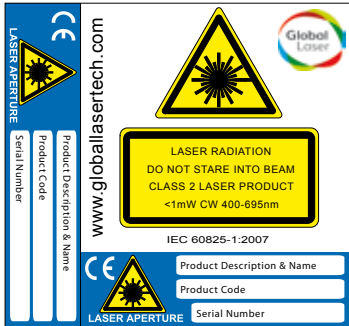

Class 2 Label

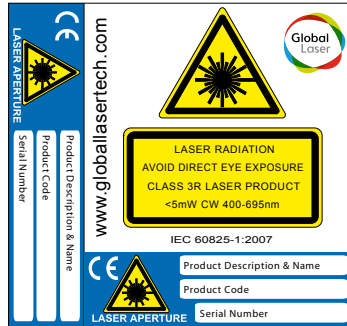

Class 3R Label

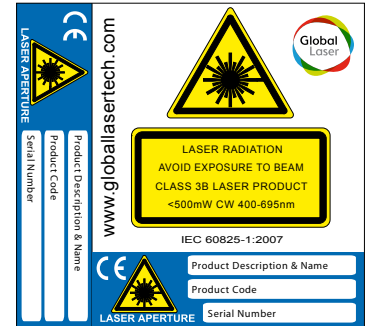

Class 3B Label

# Quality & Warranty

The FireFly range is supplied with a 12 month parts and labour warranty. Our manufacturing operations are certified to ISO9001.





# Mechanical Drawings

## FireFly

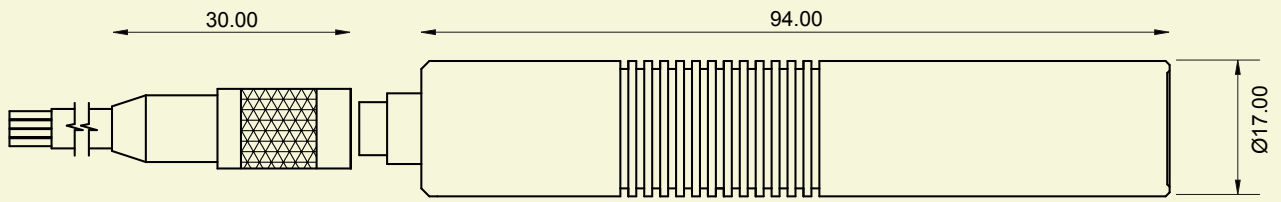

## FireFly with Line or Cross Optics Fitted

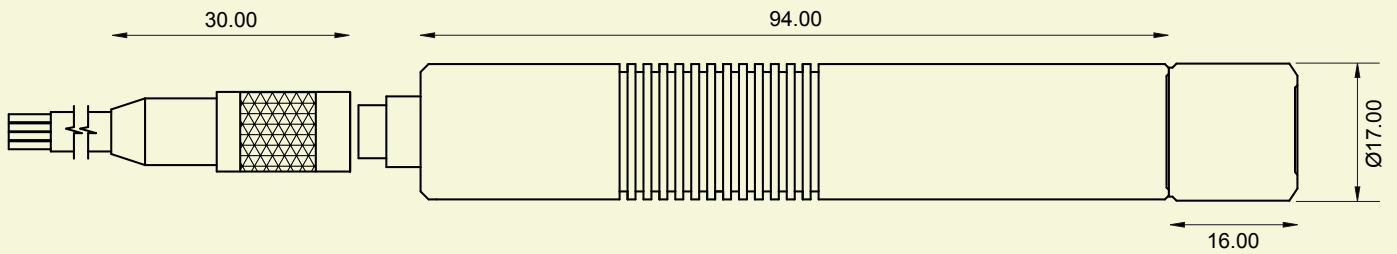

## FireFly CW

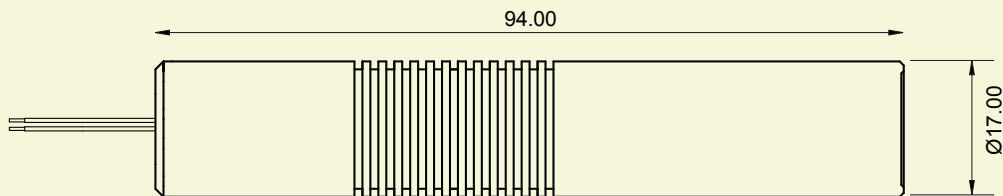

## FireFly CW with Line or Cross Optics

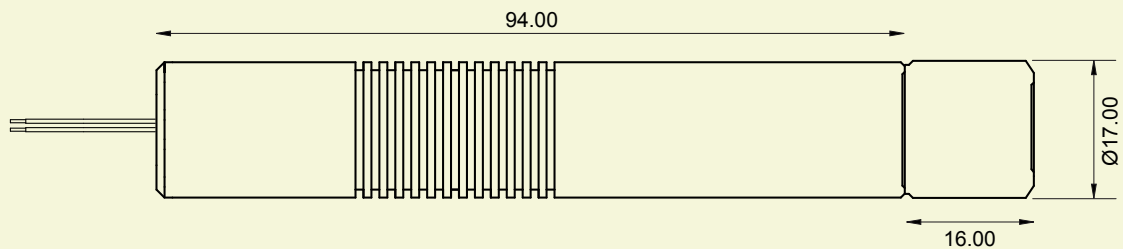

# Mechanical Drawings

## Magnetic Base

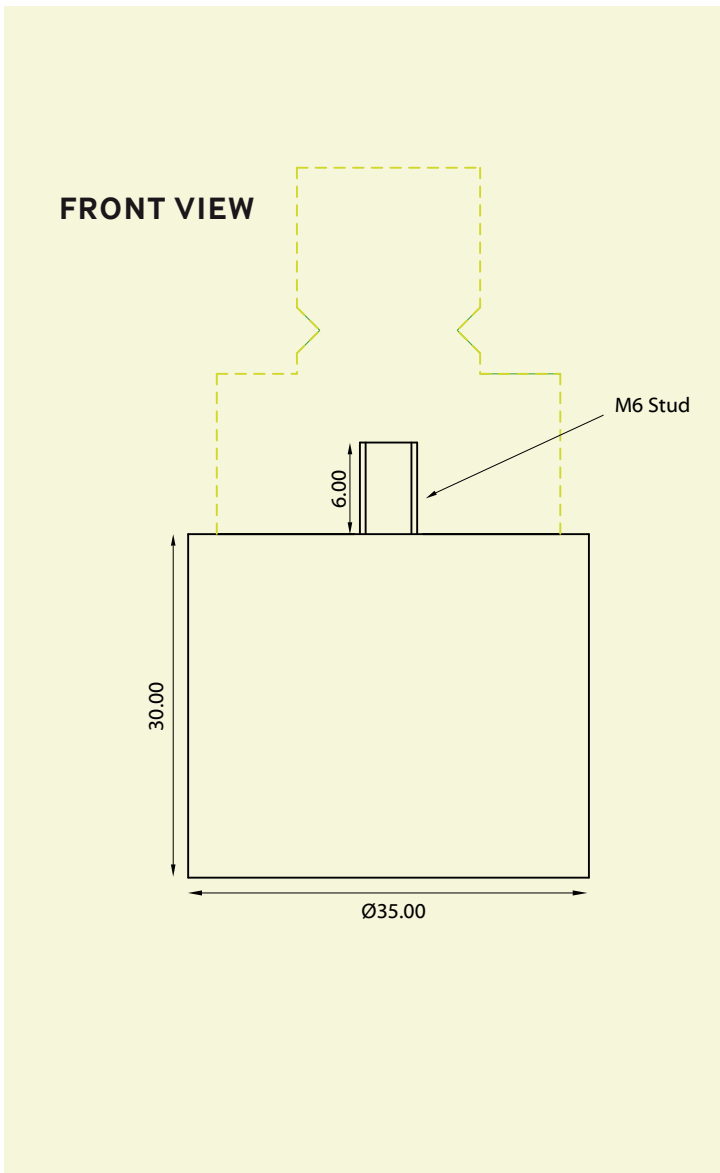

## Large Mounting Clamp

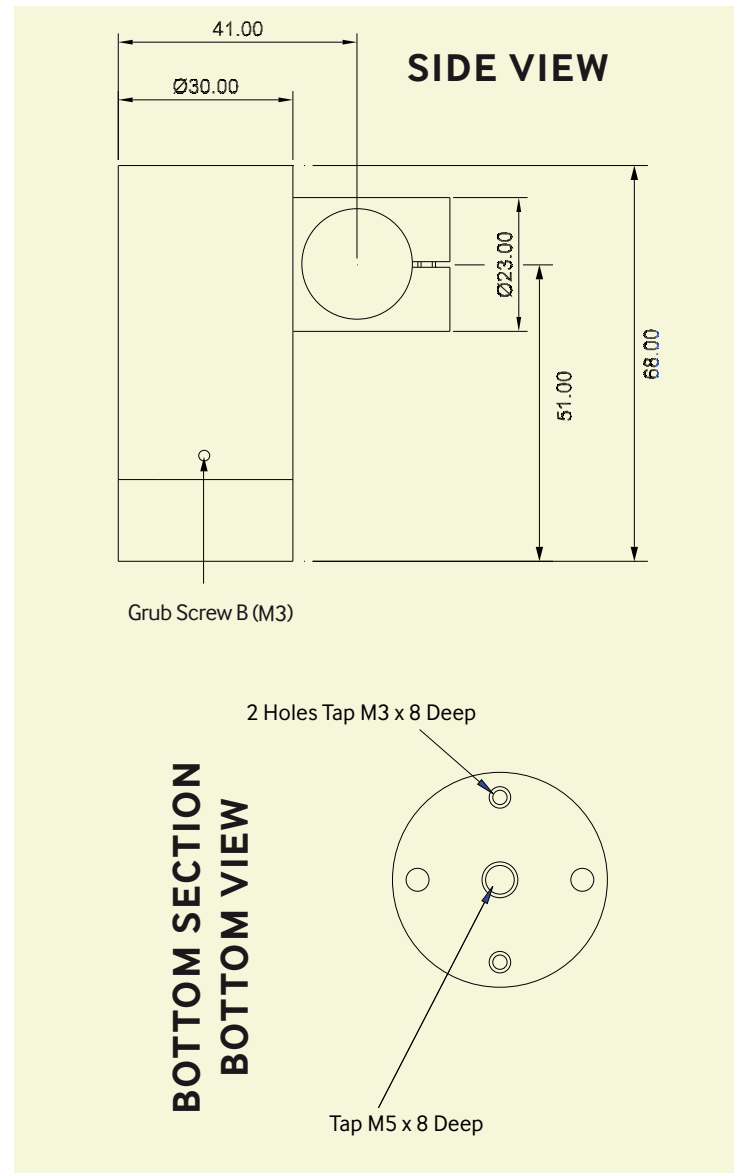

*Drawings not to scale*

For further information about any of our products please contact your local distributor or you can contact Global Laser in the UK. Your Local Distributor is:

Please note: Global Laser reserve the right to change descriptions and specifications without notice.



9090-05-037 Rev 5 27/01/2014

T: +44 (0)1495 212213  
F: +44 (0)1495 214004  
E: sales@globalasertech.com  
www.globalasertech.com

Global Laser Ltd  
Unit 9-10  
Roseheyworth Business Park  
Abertillery, Gwent NP13 1SP UK