



LED Tri-proof Light

1500mm, 50W

Features

- Strictly designed based on IP65 protection, waterproof, dust proof and corrosion proof performance.
- High energy efficiency light source service more than 50,000hours, greatly improve the fixture's life span.
- All-in-one stream line body makes the fixture fashionable and modern, easily acceptable.
- Perfect heat dissipation and low operation temperature.
- Unique design and stainless steel mounting clips, easy for installation.

Pictures



Specifications

Product Name	50W LED Tri-proof Light
Model No.	XP-PL3050
Size	1500*124*43mm
Power	50W
LED Chip	SMD 2835, Epistar chip
LED Qtys	336pcs
Input Voltage	AC 100-277V
Frequency	50/60Hz
PF	>0.9
Light Efficiency	110Lm/W
LED Luminous Flux	Cool White: 5500Lm Neutral White: 5460Lm Warm White: 5400Lm
Illumination Uniformity	>90%
Color Temperature	Cool White: 5800-6100K Neutral White: 4000-4200K Warm White: 3000-3150K
CRI	Ra>80
LED Node Temperature	≤ 55°C
Operation Ambient Temperature	-20-40°C
Storage Temperature	-25-50°C
IP Grade	IP65
Color Tolerance Adjustment	5SDCM
LED Lifespan	50,000 Hours
Power Supply Fixation	Build-in
Beam Angle	120 degree
Housing color optional	White/Black/Silver/Gold
Certificates Available	UL, DLC
Warranty	5 YEARS

Dimension Drawing

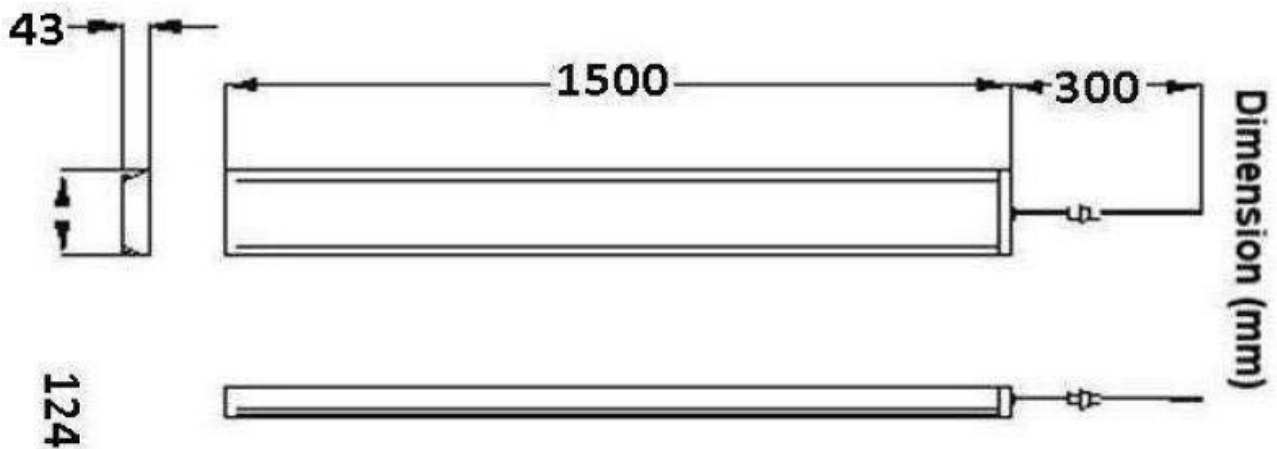

Average Illumination

Illuminance-Distance Curve

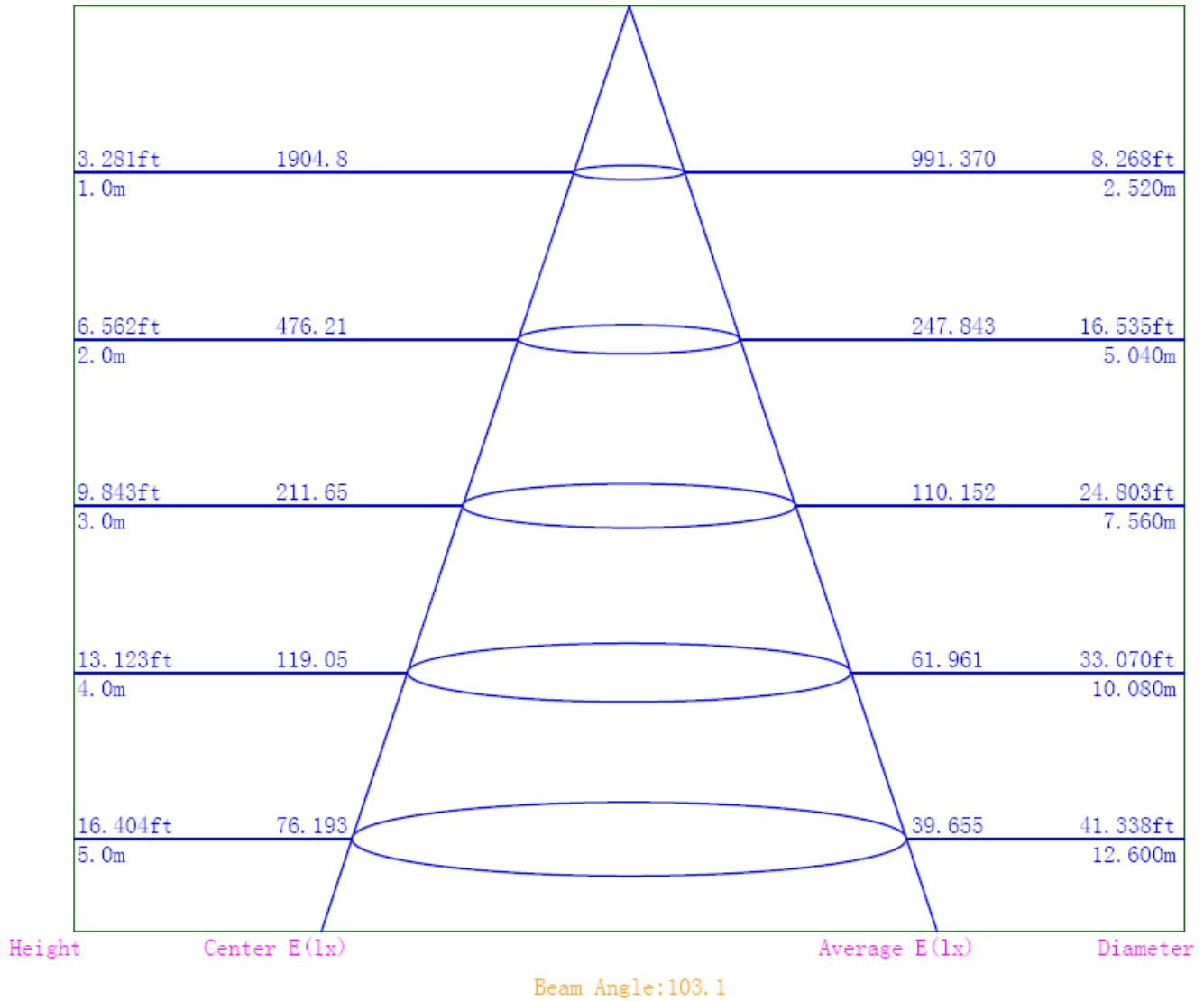

Installation Notes

Warning:

1. Improper installation may lead to falls, electric shock and fire. Please use a licensed electrician to install the lamp.
2. Turn power off when installing or maintaining the lamp in order to Avoid electric shock
3. No user serviceable parts inside. Do not open lamp as it will void warranty.
4. Please do not retrofit lamps or replace parts, in order to avoid Electric shock and fire.
5. If the lamp fails to operate normally, turn the power off and Disconnect it from the power source if possible, then contact the Supplier where you purchased the lamp.
6. The input voltage of lamps and lanterns AC100-277 V 50-60 Hz, black wire connect to "L", white wire connect to "N".
7. IP65 Protection, widely use for food processing factory, car park lot, warehouse, subway station, farms etc.
8. Suitable for the operating environment is not more than 40 ° C.
9. Use Listed waterproof bushing at outlet box for connections.

Option 1: Ceiling Type Installation



1. Cutting holes as the picture shows.

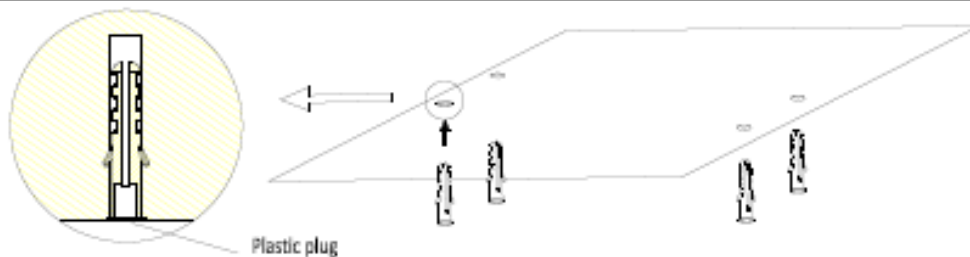

2. Push the plastic plug into the cutting holes until they are flush with the ceiling surface.

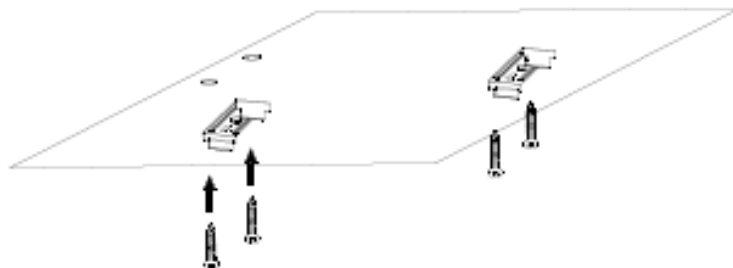

3. Lock the clips on the ceiling by driving the screws into the plastic plugs

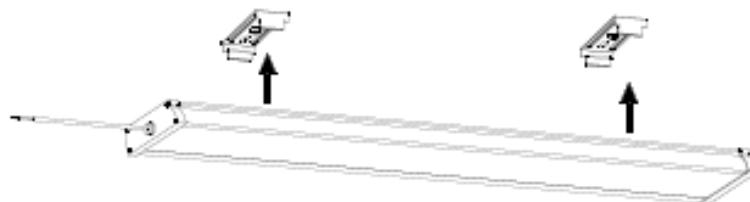

4. Put the lamp into the clips and check that it is securely held



5. Connect to the power supply.

Option 2: Hoisting Type Installation

1. Cutting holes, put plastic plug and lock the clips on the ceiling with self-taping screws.



2. Hang the lamp with lifting role and clip and then connect to the power with AC100-277V

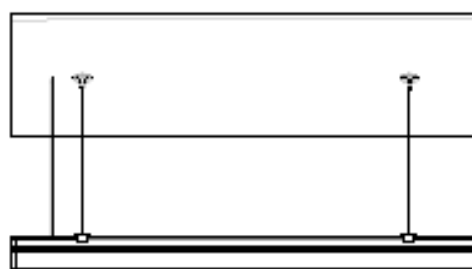
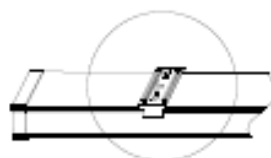

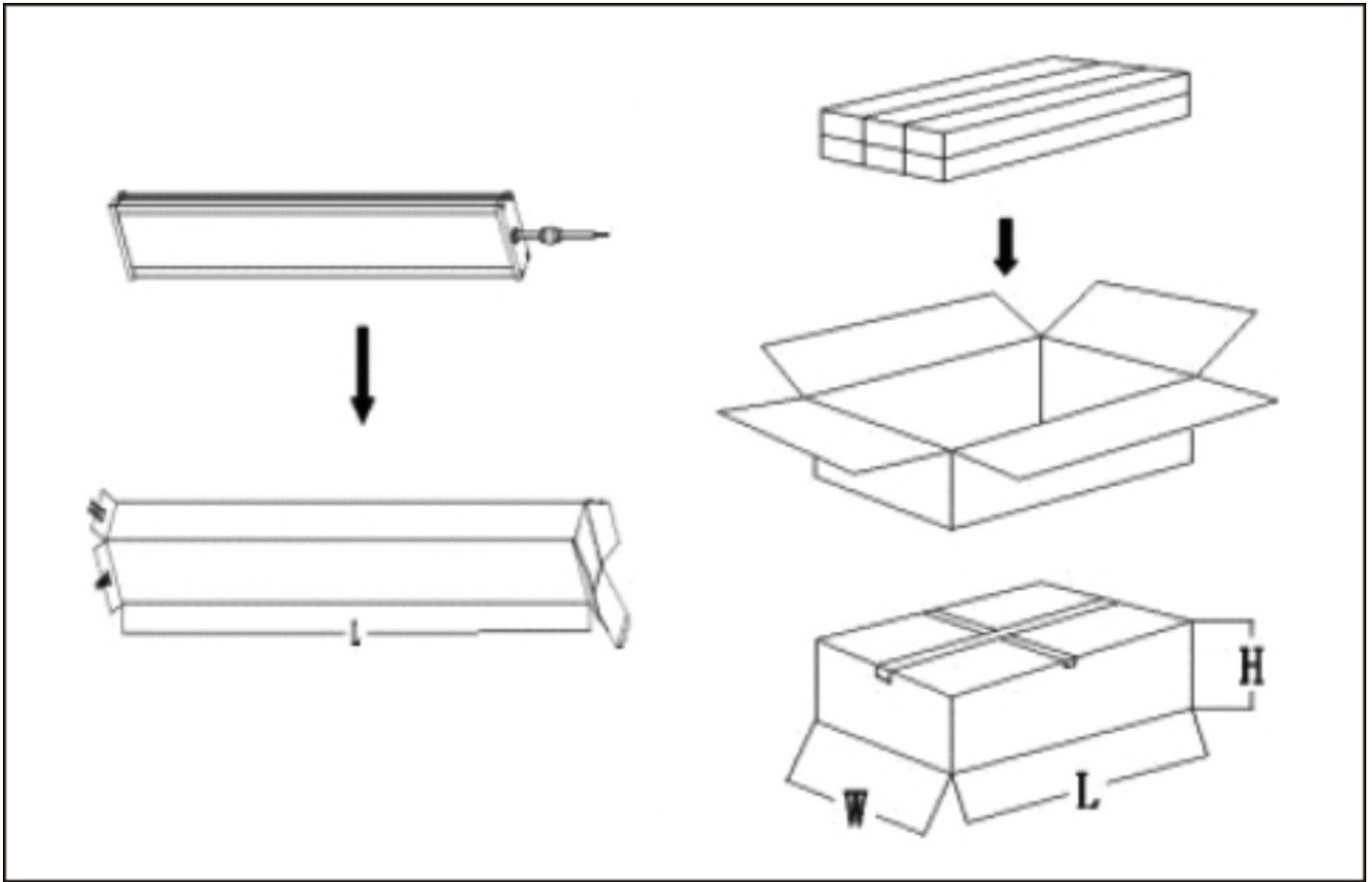

- Inner Box Size: 155*13.5*5cm NW: 2.9kg GW: 3.2kg
- Outer Carton Size: 162.5*28.5*16.5cm NW: 16.2kg GW: 21kg , 6pcs/ctn

Application

Applications: indoors and semi-outdoors

- Factory (Food processing factory/Shed/ Warehouse/Livestock farm)
- Sports Center (Gym/ Swimming pool/Changing room)
- Commercial (Supermarket/Shops/Exhibition hall)
- Public Service (Parking place/ Walkway/Tunnel/Basement/Metro/Train&Bus& Railway station/ Airport/ Library/School)